

## User's Manual



# *CrossPoint 450 Plus Series* *MAV Plus Series* Matrix Switchers

# Precautions

## Safety Instructions • English



This symbol is intended to alert the user of important operating and maintenance (servicing) instructions in the literature provided with the equipment.



This symbol is intended to alert the user of the presence of uninsulated dangerous voltage within the product's enclosure that may present a risk of electric shock.

### Caution

**Read Instructions** • Read and understand all safety and operating instructions before using the equipment.

**Retain Instructions** • The safety instructions should be kept for future reference.

**Follow Warnings** • Follow all warnings and instructions marked on the equipment or in the user information.

**Avoid Attachments** • Do not use tools or attachments that are not recommended by the equipment manufacturer because they may be hazardous.

## Consignes de Sécurité • Français



Ce symbole sert à avertir l'utilisateur que la documentation fournie avec le matériel contient des instructions importantes concernant l'exploitation et la maintenance (réparation).



Ce symbole sert à avertir l'utilisateur de la présence dans le boîtier de l'appareil de tensions dangereuses non isolées posant des risques d'électrocution.

### Attention

**Lire les instructions** • Prendre connaissance de toutes les consignes de sécurité et d'exploitation avant d'utiliser le matériel.

**Conservier les instructions** • Ranger les consignes de sécurité afin de pouvoir les consulter à l'avenir.

**Respecter les avertissements** • Observer tous les avertissements et consignes marqués sur le matériel ou présentés dans la documentation utilisateur.

**Eviter les pièces de fixation** • Ne pas utiliser de pièces de fixation ni d'outils non recommandés par le fabricant du matériel car cela risquerait de poser certains dangers.

## Sicherheitsanleitungen • Deutsch



Dieses Symbol soll dem Benutzer in der im Lieferumfang enthaltenen Dokumentation besonders wichtige Hinweise zur Bedienung und Wartung (Instandhaltung) geben.



Dieses Symbol soll den Benutzer darauf aufmerksam machen, daß im Inneren des Gehäuses dieses Produktes gefährliche Spannungen, die nicht isoliert sind und die einen elektrischen Schock verursachen können, herrschen.

### Achtung

**Lesen der Anleitungen** • Bevor Sie das Gerät zum ersten Mal verwenden, sollten Sie alle Sicherheits- und Bedienungsanleitungen genau durchlesen und verstehen.

**Aufbewahren der Anleitungen** • Die Hinweise zur elektrischen Sicherheit des Produktes sollten Sie aufbewahren, damit Sie im Bedarfsfall darauf zurückgreifen können.

**Befolgen der Warnhinweise** • Befolgen Sie alle Warnhinweise und Anleitungen auf dem Gerät oder in der Benutzerdokumentation.

**Keine Zusatzgeräte** • Verwenden Sie keine Werkzeuge oder Zusatzgeräte, die nicht ausdrücklich vom Hersteller empfohlen wurden, da diese eine Gefahrenquelle darstellen können.

## Instrucciones de seguridad • Español



Este símbolo se utiliza para advertir al usuario sobre instrucciones importantes de operación y mantenimiento (o cambio de partes) que se desean destacar en el contenido de la documentación suministrada con los equipos.



Este símbolo se utiliza para advertir al usuario sobre la presencia de elementos con voltaje peligroso sin protección aislante, que puedan encontrarse dentro de la caja o alojamiento del producto, y que puedan representar riesgo de electrocución.

### Precaucion

**Leer las instrucciones** • Leer y analizar todas las instrucciones de operación y seguridad, antes de usar el equipo.

**Conservar las instrucciones** • Conservar las instrucciones de seguridad para futura consulta.

**Obedecer las advertencias** • Todas las advertencias e instrucciones marcadas en el equipo o en la documentación del usuario, deben ser obedecidas.

**Evitar el uso de accesorios** • No usar herramientas o accesorios que no sean específicamente recomendados por el fabricante, ya que podrían implicar riesgos.

## 安全须知 • 中文



这个符号提示用户该设备用户手册中有重要的操作和维护说明。



这个符号警告用户该设备机壳内有暴露的危险电压，有触电危险。

### 注意

**阅读说明书** • 用户使用该设备前必须阅读并理解所有安全和使用说明。

**保存说明书** • 用户应保存安全说明书以备将来使用。

**遵守警告** • 用户应遵守产品和用户指南上的所有安全和操作说明。

**避免追加** • 不要使用该产品厂商没有推荐的工具或追加设备，以避免危险。

## Warning

**Power sources** • This equipment should be operated only from the power source indicated on the product. This equipment is intended to be used with a main power system with a grounded (neutral) conductor. The third (grounding) pin is a safety feature, do not attempt to bypass or disable it.

**Power disconnection** • To remove power from the equipment safely, remove all power cords from the rear of the equipment, or the desktop power module (if detachable), or from the power source receptacle (wall plug).

**Power cord protection** • Power cords should be routed so that they are not likely to be stepped on or pinched by items placed upon or against them.

**Servicing** • Refer all servicing to qualified service personnel. There are no user-serviceable parts inside. To prevent the risk of shock, do not attempt to service this equipment yourself because opening or removing covers may expose you to dangerous voltage or other hazards.

**Slots and openings** • If the equipment has slots or holes in the enclosure, these are provided to prevent overheating of sensitive components inside. These openings must never be blocked by other objects.

**Lithium battery** • There is a danger of explosion if battery is incorrectly replaced. Replace it only with the same or equivalent type recommended by the manufacturer. Dispose of used batteries according to the manufacturer's instructions.

## Avertissement

**Alimentations** • Ne faire fonctionner ce matériel qu'avec la source d'alimentation indiquée sur l'appareil. Ce matériel doit être utilisé avec une alimentation principale comportant un fil de terre (neutre). Le troisième contact (de mise à la terre) constitue un dispositif de sécurité : n'essayez pas de la contourner ni de la désactiver.

**Déconnexion de l'alimentation** • Pour mettre le matériel hors tension sans danger, déconnectez tous les cordons d'alimentation de l'arrière de l'appareil ou du module d'alimentation de bureau (s'il est amovible) ou encore de la prise secteur.

**Protection du cordon d'alimentation** • Acheminer les cordons d'alimentation de manière à ce que personne ne risque de marcher dessus et à ce qu'ils ne soient pas écrasés ou pincés par des objets.

**Réparation-maintenance** • Faire exécuter toutes les interventions de réparation-maintenance par un technicien qualifié. Aucun des éléments internes ne peut être réparé par l'utilisateur. Afin d'éviter tout danger d'électrocution, l'utilisateur ne doit pas essayer de procéder lui-même à ces opérations car l'ouverture ou le retrait des couvercles risquent de l'exposer à de hautes tensions et autres dangers.

**Fentes et orifices** • Si le boîtier de l'appareil comporte des fentes ou des orifices, ceux-ci servent à empêcher les composants internes sensibles de surchauffer. Ces ouvertures ne doivent jamais être bloquées par des objets.

**Lithium Batterie** • Il a danger d'explosion s'il y a remplacement incorrect de la batterie. Remplacer uniquement avec une batterie du même type ou d'un type équivalent recommandé par le constructeur. Mettre au rebut les batteries usagées conformément aux instructions du fabricant.

## Vorsicht

**Stromquellen** • Dieses Gerät sollte nur über die auf dem Produkt angegebene Stromquelle betrieben werden. Dieses Gerät wurde für eine Verwendung mit einer Hauptstromleitung mit einem geerdeten (neutralen) Leiter konzipiert. Der dritte Kontakt ist für einen Erdschluß, und stellt eine Sicherheitsfunktion dar. Dieses sollte nicht umgangen oder außer Betrieb gesetzt werden.

**Stromunterbrechung** • Um das Gerät auf sichere Weise vom Netz zu trennen, sollten Sie alle Netzkabel aus der Rückseite des Gerätes, aus der externen Stromversorgung (falls dies möglich ist) oder aus der Wandsteckdose ziehen.

**Schutz des Netzkabels** • Netzkabel sollten stets so verlegt werden, daß sie nicht im Weg liegen und niemand darauf treten kann oder Objekte darauf- oder unmittelbar dagegengestellt werden können.

**Wartung** • Alle Wartungsmaßnahmen sollten nur von qualifiziertem Servicepersonal durchgeführt werden. Die internen Komponenten des Gerätes sind wartungsfrei. Zur Vermeidung eines elektrischen Schocks versuchen Sie in keinem Fall, dieses Gerät selbst öffnen, da beim Entfernen der Abdeckungen die Gefahr eines elektrischen Schlags und/oder andere Gefahren bestehen.

**Schlitze und Öffnungen** • Wenn das Gerät Schlitze oder Löcher im Gehäuse aufweist, dienen diese zur Vermeidung einer Überhitzung der empfindlichen Teile im Inneren. Diese Öffnungen dürfen niemals von anderen Objekten blockiert werden.

**Lithium-Batterie** • Explosionsgefahr, falls die Batterie nicht richtig ersetzt wird. Ersetzen Sie verbrauchte Batterien nur durch den gleichen oder einen vergleichbaren Batterietyp, der auch vom Hersteller empfohlen wird. Entsorgen Sie verbrauchte Batterien bitte gemäß den Herstelleranweisungen.

## Advertencia

**Alimentación eléctrica** • Este equipo debe conectarse únicamente a la fuente/tipo de alimentación eléctrica indicada en el mismo. La alimentación eléctrica de este equipo debe provenir de un sistema de distribución general con conductor neutro a tierra. La tercera pata (puesta a tierra) es una medida de seguridad, no puentearla ni eliminarla.

**Desconexión de alimentación eléctrica** • Para desconectar con seguridad la acometida de alimentación eléctrica al equipo, desenchufar todos los cables de alimentación en el panel trasero del equipo, o desenchufar el módulo de alimentación (si fuera independiente), o desenchufar el cable del receptáculo de la pared.

**Protección del cable de alimentación** • Los cables de alimentación eléctrica se deben instalar en lugares donde no sean pisados ni apretados por objetos que se puedan apoyar sobre ellos.

**Reparaciones/mantenimiento** • Solicitar siempre los servicios técnicos de personal calificado. En el interior no hay partes a las que el usuario deba acceder. Para evitar riesgo de electrocución, no intentar personalmente la reparación/mantenimiento de este equipo, ya que al abrir o extraer las tapas puede quedar expuesto a voltajes peligrosos u otros riesgos.

**Ranuras y aberturas** • Si el equipo posee ranuras o orificios en su caja/alojamiento, es para evitar el sobrecalentamiento de componentes internos sensibles. Estas aberturas nunca se deben obstruir con otros objetos.

**Batería de litio** • Existe riesgo de explosión si esta batería se coloca en la posición incorrecta. Cambiar esta batería únicamente con el mismo tipo (o su equivalente) recomendado por el fabricante. Desachar las baterías usadas siguiendo las instrucciones del fabricante.

## 警告

**电源** • 该设备只能使用产品上标明的电源。设备必须使用有地线的供电系统供电。第三条线（地线）是安全设施，不能不用或跳过。

**拔掉电源** • 为安全地从设备拔掉电源，请拔掉所有设备后或桌面电源的电源线，或任何接到市电系统的电源线。

**电源线保护** • 妥善布线，避免被踩踏，或重物挤压。

**维护** • 所有维修必须由认证的维修人员进行。设备内部没有用户可以更换的零件。为避免出现触电危险不要自己试图打开设备盖子维修该设备。

**通风孔** • 有些设备机壳上有通风槽或孔，它们是用来防止机内敏感元件过热。不要使用任何东西挡住通风孔。

**锂电池** • 不正确的更换电池会有爆炸的危险。必须使用与厂家推荐的相同或相近型号的电池。按照生产的建议处理废弃电池。

## FCC Class A Notice

**NOTE** This equipment has been tested and found to comply with the limits for a Class A digital device, pursuant to part 15 of the FCC Rules. These limits are designed to provide reasonable protection against harmful interference when the equipment is operated in a commercial environment. This equipment generates, uses and can radiate radio frequency energy and, if not installed and used in accordance with the instruction manual, may cause harmful interference to radio communications. Operation of this equipment in a residential area is likely to cause harmful interference, in which case the user will be required to correct the interference at his own expense.

**NOTE** This unit was tested with shielded cables on the peripheral devices. Shielded cables must be used with the unit to ensure compliance.

This device complies with Part 15 of the FCC Rules. Operation is subject to the following two conditions: (1) this device may not cause harmful interference, and (2) this device must accept any interference received, including interference that may cause undesired operation.

# Quick Start — CrossPoint 450 Plus and MAV Plus Switchers

## Installation

### 1

Turn off power to the input and output devices, and remove the power cords from them.

### 2 (video models)

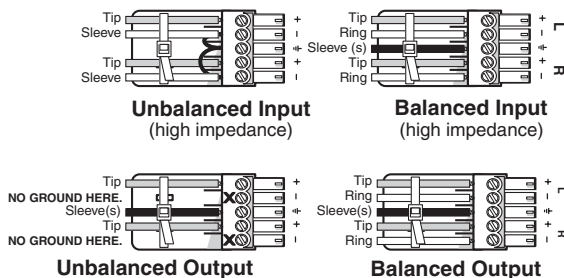
**CrossPoint 450 Plus** — Cable the switcher for RGBHV, RGBS, RGSB, RsGsBs, component/HDTV video, S-video, or composite video input and output.

**MAV Plus video models** — Cable the switcher for component/HDTV video, S-video, or composite video input and output.

**NOTE** See chapter 2, "Installation", to connect the various video formats to and from the various models.

### 3 (models with audio)

**Most models with audio** — Cable the switcher for audio input and output. High impedance is generally over 800 ohms.



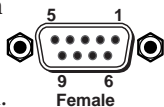
**CAUTION** Connect the sleeve to ground. Connecting the sleeve to a negative (-) terminal will damage the audio output circuits.

**MAV Plus 128 AV RCA** — Cable the switcher for stereo audio input and output. Each input and output has two RCA connectors (left and right) for unbalanced audio input or output.



### 4

If desired, connect a control system or computer to the rear panel Remote RS-232/RS-422 port. See the pinout table in the next column.



### 5 (Matrix sizes up to 1616)

If desired, connect a control system or computer to the front panel Configuration (RS-232) port. Use an optional 9-pin D to 2.5 mm mini jack TRS RS-232 cable, part #70-335-01.

Pin#	RS-232			RS-422		
	Pin	Function	Pin	Function	Pin	Function
1	—	Not used	—	Not used	TX+	Transmit +
2	TX	Transmit	TX-	Transmit -	TX-	Transmit -
3	RX	Receive	RX-	Receive -	RX+	Receive +
4	—	Not used	—	Not used	RX-	Receive -
5	Gnd	Ground	Gnd	Ground	Gnd	Ground
6	—	Not used	—	Not used	—	Not used
7	—	Not used	RX+	Receive +	—	Not used
8	—	Not used	TX+	Transmit +	—	Not used
9	—	Not used	—	Not used	—	Not used

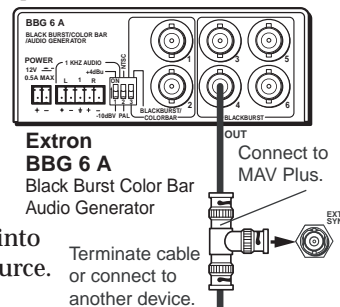
### 6

If desired, connect a network WAN or LAN hub, a control system, or computer to the Ethernet RJ-45 port. See chapter 2, "Installation", for details.

- **Network connection** — Wire as a patch (straight) cable.
- **Computer or control system connection** — Wire the interface cable as a crossover cable.

### 7 (MAV Plus)

If desired, attach an external sync timing device to the external sync connectors.



### 8

Plug the switcher into a grounded AC source.

Terminate cable or connect to another device.

## Definitions

**Tie** — An input-to-output connection.

**Set of ties** — An input tied to 2 or more outputs.

**Configuration** — One or more ties or sets of ties.

**Current configuration** — The currently active configuration (also called **configuration 0**).

**Global preset** — A configuration that has been stored. One global preset can be assigned to each input button. When a global preset is retrieved from memory, it becomes the **current configuration**.

## Front Panel Controls

**Input and output buttons** select inputs and outputs. Output buttons light **amber** to indicate video and audio ties. The buttons light **green** to indicate video-only ties. The buttons light **red** to indicate audio-only ties. Input and output buttons also select presets.



# Quick Start — CrossPoint 450 Plus and MAV Plus Switchers, Cont'd

On audio models, the output buttons also display the selected input's audio level.

On audio models, the input buttons also display the selected output's volume level.

**Enter button** saves changes.

**Preset button** saves a configuration as a preset or recalls a previously-defined preset.

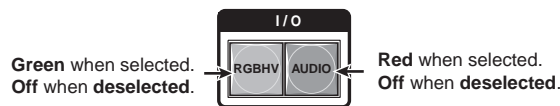
**View button** selects a view-only mode that prevents inadvertent configuration changes. On audio models, View decrements the level and volume. See "View, adjust the audio level".

**Esc button** cancels selections in progress and resets the front panel button indications. The Esc button does **not** reset: the current configuration, the RGBHV or video and audio selection, any presets, or any audio level or volume settings. On audio models, Esc increments the level and volume. See "View, adjust the audio level".

**RGBHV (CrossPoint 450 Plus)/Video (MAV Plus) and Audio buttons** select/deselect video and/or audio. The Audio button blinks to indicate audio breakaway. The Audio button also selects the audio level/adjust mode. See "View, adjust the audio level".

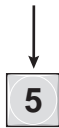
## Create a tie

1. Press and release the RGBHV/Video and/or Audio I/O button(s) to select or deselect video and/or audio as desired.



2. Press and release the desired input button.

The button lights to indicate the selection.



3. Press and release the desired output button(s).

Amber indicates RGBHV/video and audio tie.  
Green indicates RGBHV/video only tie.  
Red indicates audio only tie.

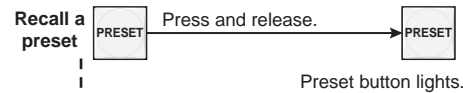
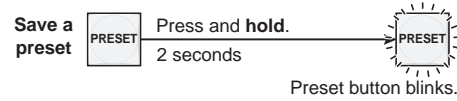


Green indicates the need to confirm the change.

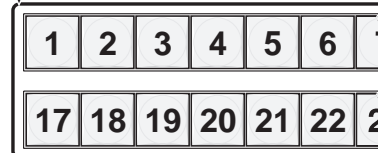
4. Press and release the Enter button.

## Save or recall a preset

1. **Save a preset** — Press and hold the Preset button for 2 seconds.



- All input and output buttons with assigned presets light red.
- The configuration data at assigned preset locations will be overwritten.



2. Press and release the desired input or output button.

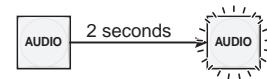
The button blinks red to indicate that this preset is selected to save or recall.



3. Press and release the Enter button.

## View, adjust the audio level

1. Press and hold the Audio button.



2. Press an input or output button. See chapter 3 to read the displayed value.

Press and Hold

5. Press an **Input** button to adjust gain/attenuation.  
Press an **Output** button to adjust volume.



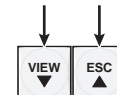
Output buttons display gain/attenuation.  
Input buttons display volume.



1 Lit button    1 Unlit button

3. Increase and decrease the gain/attenuation or volume level by pressing the Esc (▲) and View (▼) buttons.

View ▼ button decreases the level or volume.  
Esc ▲ button increases the level or volume.



4. Press and release the Audio button to exit.

# Table of Contents

---

<b>Chapter 1 • Introduction</b> .....	1-1
<b>About this Manual</b> .....	1-2
<b>About the Matrix Switchers</b> .....	1-2
CrossPoint 450 Plus switchers .....	1-5
MAV Plus switchers .....	1-6
<b>Definitions</b> .....	1-7
<b>Features</b> .....	1-8
<b>Chapter 2 • Installation</b> .....	2-1
<b>Mounting the Switcher</b> .....	2-2
UL requirements .....	2-2
Mounting instructions .....	2-2
<b>Rear Panel Views</b> .....	2-3
CrossPoint 450 Plus switchers .....	2-3
MAV Plus switchers .....	2-5
<b>Rear Panel Connections</b> .....	2-8
Video input and output (video switchers) .....	2-8
RGBHV (CrossPoint 450 Plus switchers only) .....	2-8
Video (MAV Plus switchers only) .....	2-10
Sync termination switches (CrossPoint 450 Plus only) .....	2-12
Audio input and output (models with audio only) .....	2-13
Captive screw connector models (all except MAV Plus 128 AV RCA) .....	2-13
RCA connector model (MAV Plus 128 AV RCA) .....	2-14
RS-232/RS-422 .....	2-14
Ethernet .....	2-15
Cabling and RJ-45 connector wiring .....	2-15
Reset button .....	2-16
External sync (MAV Plus video models only) .....	2-17
Power .....	2-18
<b>Front Panel Configuration Port (Matrix Sizes up to 1616 Only)</b> .....	2-18
<b>Chapter 3 • Operation</b> .....	3-1
<b>Front Panel Controls and Indicators</b> .....	3-2
Definitions .....	3-4
Input and output buttons .....	3-4
Control buttons .....	3-5
I/O controls .....	3-8
Power indicators (2412 and larger models only) .....	3-9
Button icons .....	3-9

## Table of Contents, cont'd

---

<b>Front Panel Operations</b> .....	3-9
Front panel security lockouts .....	3-9
Power .....	3-10
Creating a configuration .....	3-10
Example 1: Creating a set of video and audio ties .....	3-11
Example 2: Adding a tie to a set of video and audio ties .....	3-13
Example 3: Removing a tie from a set of video and audio ties .....	3-15
Viewing a configuration .....	3-17
Example 4: Viewing video and audio, audio only, and video only ties .....	3-18
I/O grouping .....	3-21
Example 5: Grouping inputs and outputs .....	3-23
Setting RGB delay (CrossPoint 450 Plus switchers only) .....	3-26
Example 6: Setting the RGB delay for an output .....	3-26
Using presets .....	3-28
Example 7: Saving a preset .....	3-29
Example 8: Recalling a preset .....	3-31
Muting and unmuting video and/or audio outputs .....	3-32
Example 9: Muting and unmuting an output .....	3-33
Viewing and adjusting the input audio level (audio models) .....	3-35
Example 10: Viewing and adjusting an input audio level .....	3-36
Viewing and adjusting the output volume (audio models) .....	3-41
Reading the displayed volume .....	3-42
Example 11: Viewing and adjusting an output volume level .....	3-45
Setting the front panel locks ( <i>Executive modes</i> ) .....	3-48
Selecting <i>Lock mode 2</i> or toggling between mode 2 and mode 0 .....	3-49
Selecting <i>Lock mode 2</i> or toggling between mode 2 and mode 1 .....	3-49
Performing a system reset from the front panel .....	3-50
Background illumination .....	3-50
Selecting the rear panel Remote port protocol and baud rate .....	3-51
<b>Rear Panel Controls</b> .....	3-53
Performing soft system resets .....	3-53
Performing a hard reset .....	3-55
<b>Optimizing the Audio (Audio Switchers)</b> .....	3-56
<b>Troubleshooting</b> .....	3-56
General checks .....	3-56
Plasma display S-video problem (CrossPoint 450 Plus switchers only) .....	3-56
<b>Configuration Worksheets</b> .....	3-57
Worksheet example 1: System equipment .....	3-57
Worksheet example 2: Daily configuration .....	3-58
Worksheet example 3: Test configuration .....	3-59
32-button switchers configuration worksheet .....	3-61
16-button and smaller switchers configuration worksheet .....	3-63

---

<b>Chapter 4 • Programmer's Guide</b> .....	4-1
<b>Serial Ports</b> .....	4-2
Rear panel Remote port .....	4-2
Front panel Configuration port (matrix sizes up to 1616 only) .....	4-3
<b>Ethernet Link</b> .....	4-4
Ethernet connection .....	4-4
Default IP addresses .....	4-4
<b>Host-to-Switcher Instructions</b> .....	4-5
<b>Switcher-Initiated Messages</b> .....	4-5
<b>Switcher Error Responses</b> .....	4-6
<b>Using the Command/Response Tables</b> .....	4-6
<b>Command/Response Table for SIS Commands</b> .....	4-7
Symbol definitions .....	4-7
<b>Command/Response Table for IP SIS Commands</b> .....	4-17
Symbol definitions .....	4-17
<b>Special Characters</b> .....	4-19
<b>Chapter 5 • Matrix Software</b> .....	5-1
<b>Matrix Switchers Control Program</b> .....	5-2
Installing the software .....	5-2
Software operation via Ethernet .....	5-3
Ethernet protocol settings .....	5-3
Using the software .....	5-4
IP Settings/Options window .....	5-7
Matrix IP Address field .....	5-8
Extron Name/Descriptor field .....	5-8
Gateway IP Address field .....	5-9
Subnet Mask field .....	5-9
Hardware Address field .....	5-9
Use DHCP checkbox .....	5-9
Date field .....	5-10
Time (local) field .....	5-10
Sync Time to PC button .....	5-10
GMT (offset) field .....	5-10
Use Daylight Savings checkbox .....	5-11
Administrator Password field .....	5-11
User Password field .....	5-11
Mail Server IP Address field .....	5-12
Mail Server Domain Name field .....	5-12
E-mail Addressee fields .....	5-12
Update firmware .....	5-13
Ethernet-connected firmware upload .....	5-14
Serial-port-connected firmware upload .....	5-15

## Table of Contents, cont'd

---

Upload HTML files .....	5-17
Windows buttons, drop boxes, and trash .....	5-18
Windows menus .....	5-19
File menu .....	5-19
Tools menu .....	5-19
Preferences menu .....	5-21
Master Reset selection .....	5-22
Using emulation mode .....	5-22
Using the help system .....	5-22
<b>Special Characters</b> .....	5-22
<b>Button Label Generator</b> .....	5-23
Using the software .....	5-23
<b>Chapter 6 • HTML Operation</b> .....	6-1
<b>Download the Startup Page</b> .....	6-2
<b>System Status Page</b> .....	6-3
DSVP page (CrossPoint 450 Plus switchers only) .....	6-4
<b>System Configuration Page</b> .....	6-5
IP Settings fields .....	6-6
Unit Name field .....	6-6
DHCP radio buttons .....	6-6
IP Address field .....	6-6
Gateway IP Address field .....	6-6
Subnet Mask field .....	6-6
MAC Address field .....	6-6
Date/Time Settings fields .....	6-7
Passwords page .....	6-8
Email Settings page .....	6-9
Mail IP address field .....	6-9
Domain Name field .....	6-9
Email address fields .....	6-10
Firmware Upgrade page .....	6-10
<b>File Management Page</b> .....	6-11
<b>Set and View Ties Page</b> .....	6-12
Create or delete a tie .....	6-13
RGB and Audio Settings page .....	6-13
Change the input gain and attenuation (audio models only) .....	6-14
Mute or unmute one or all outputs .....	6-15
Change the RGB delay (CrossPoint 450 Plus switchers only) .....	6-16
Change the output volume level (audio models only) .....	6-17
Global Presets page .....	6-19
Save a preset .....	6-19
Recall a preset .....	6-19
<b>Special Characters</b> .....	6-20

---

<b>Appendix A • Ethernet Connection</b> .....	A-1
<b>Ethernet Link</b> .....	A-2
Ethernet connection .....	A-2
Default address .....	A-2
Ping to determine Extron IP address .....	A-3
Ping to determine Web IP address .....	A-3
Connect as a Telnet client .....	A-3
Telnet tips .....	A-4
Open .....	A-4
Escape character and Esc key .....	A-4
Local echo .....	A-5
Set carriage return-line feed .....	A-5
Close .....	A-5
Help .....	A-5
Quit .....	A-5
<b>Subnetting — A Primer</b> .....	A-6
Gateways .....	A-6
Local and remote devices .....	A-6
IP addresses and octets .....	A-6
Subnet masks and octets .....	A-6
Determining whether devices are on the same subnet .....	A-7
<b>Appendix B • Reference Information</b> .....	B-1
<b>CrossPoint 450 Plus Specifications</b> .....	B-2
<b>MAV Plus Specifications</b> .....	B-6
<b>Part Numbers</b> .....	B-11
CrossPoint 450 Plus part numbers .....	B-11
MAV Plus part numbers .....	B-11
Included parts .....	B-13
Replacement parts .....	B-13
Optional accessories .....	B-13
Cables .....	B-14
Bulk cable .....	B-14
Assorted connectors .....	B-14
Pre-cut cables .....	B-14
<b>Button Labels</b> .....	B-15
Installing labels in the matrix switcher’s buttons .....	B-15
Button label blanks .....	B-17

## Table of Contents, cont'd

---

*All trademarks mentioned in this manual are the properties of their respective owners.*

68-521-02 **Rev. D**  
11 07



# CrossPoint 450 Plus and MAV Plus Switchers

# Chapter One

## Introduction

About this Manual

About the Matrix Switchers

Definitions

Features



# Introduction

## About this Manual

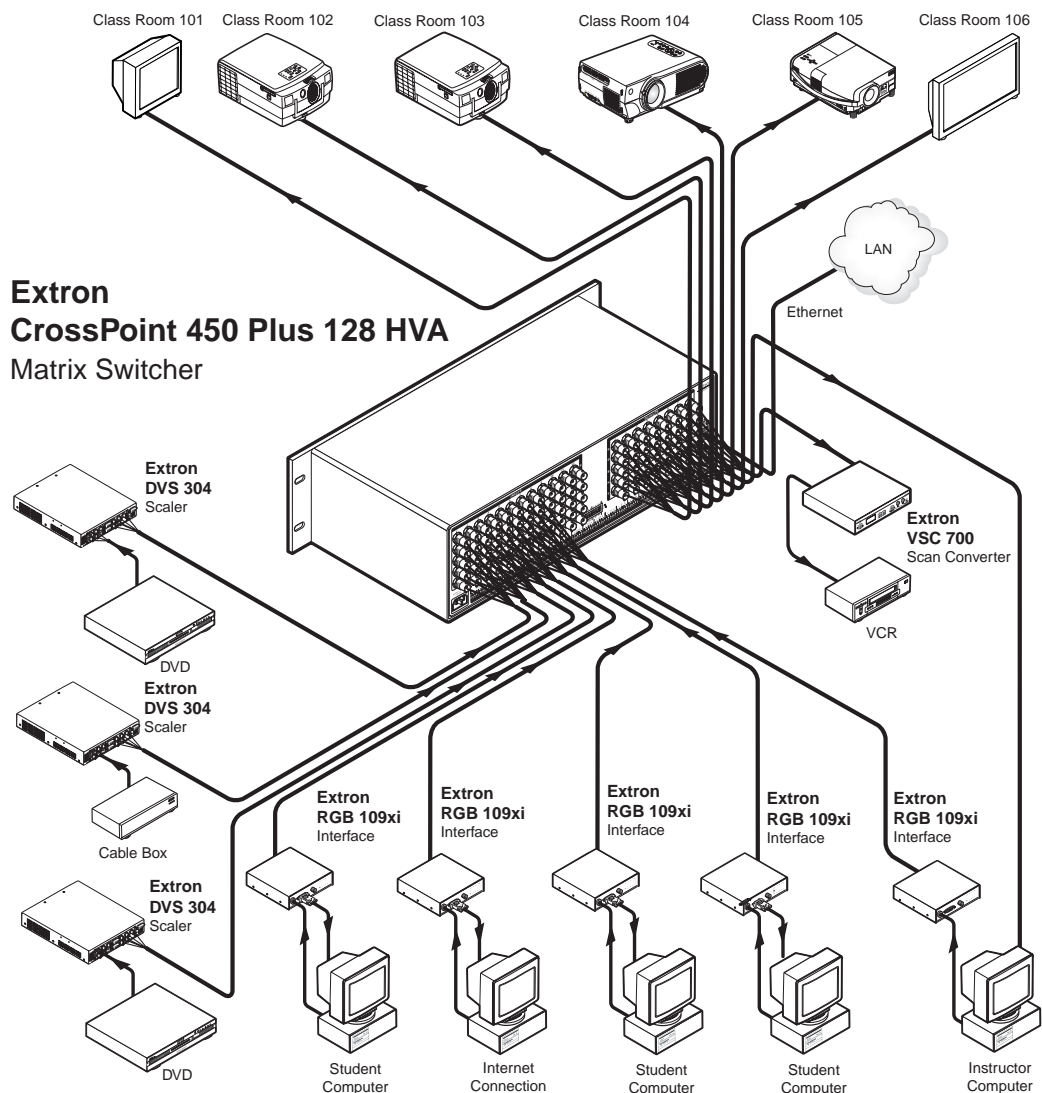
This manual contains installation, configuration, and operating information for the complete Extron family of full-function, medium- and large-sized, analog matrix switchers, specifically:

- CrossPoint 450 Plus ultra-wideband RGBHV and audio matrix switchers
- MAV Plus broadcast quality HDTV/component video, S-video, and composite video and audio matrix switchers

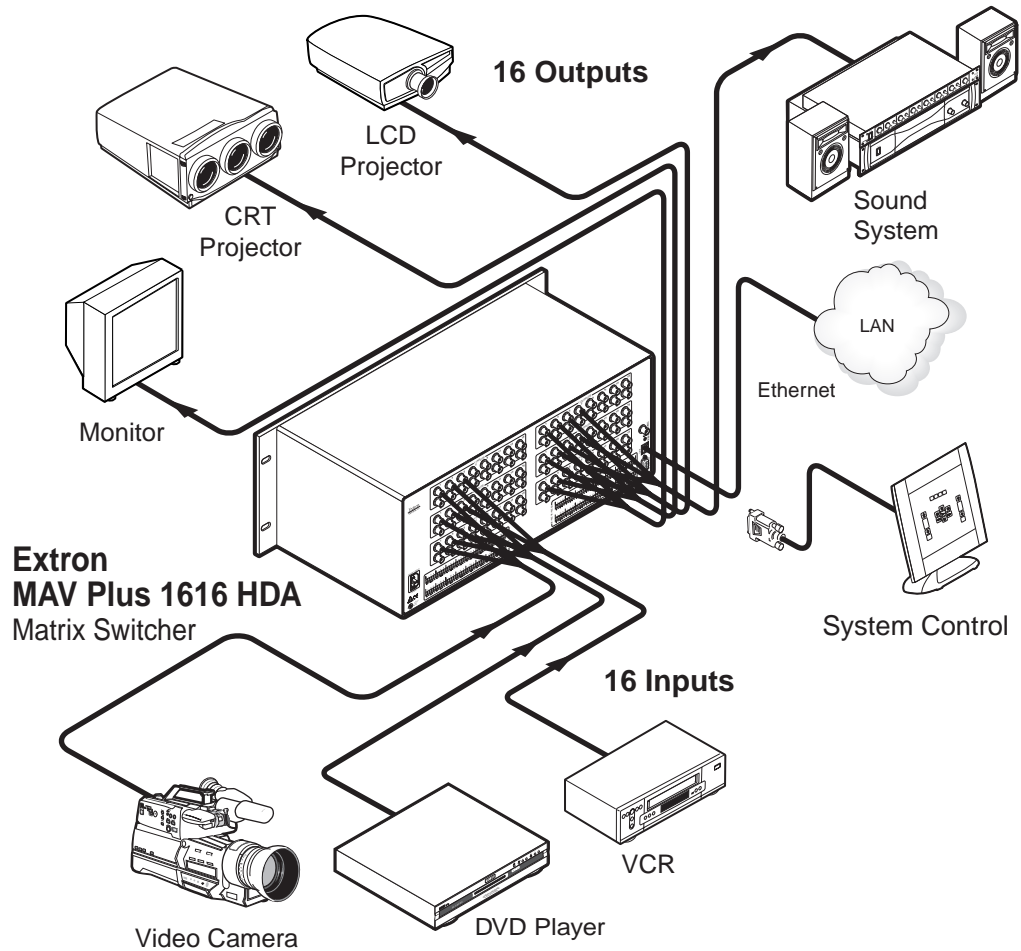
## About the Matrix Switchers

Matrix switchers distribute any input to any combination of outputs. The matrix switchers can route multiple input/output configurations simultaneously.

The matrix switchers are single box solutions to complex wideband (figure 1-1) or low resolution (figure 1-2) video and/or audio routing applications. Each input and output is individually isolated and buffered, and any input(s) can be switched to any one or all outputs with virtually no crosstalk or signal noise between channels.



**Figure 1-1 — Typical CrossPoint 450 Plus matrix switcher application**



**Figure 1-2 — Typical MAV Plus matrix switcher application**

All of the matrix switchers are available in a variety of matrix sizes (the matrix size is the number of inputs and outputs).

CrossPoint 450 Plus series switchers offer two models of each matrix size:

- HVA for switching RGBHV video and two-channel stereo audio
- HV for switching RGBHV video signals only

MAV Plus series switchers offer multiple models of all matrix sizes, with one, two, or three (MAV Plus 1616 and smaller) video planes, to support different low resolution video formats (exceptions are noted in "MAV Plus switchers" on page 1-6):

- HDA for switching component/HDTV video and two-channel stereo audio
- HD for switching component/HDTV video signals only
- SVA for switching S-video and two-channel stereo audio
- SV for switching S-video signals only
- AV for switching composite video and two-channel stereo audio
- V for switching composite video signals only
- A for switching two-channel stereo audio only

## Introduction, cont'd

---

**NOTE** *In this manual, the term “video model” refers to any CrossPoint 450 Plus or MAV Plus switcher that switches video.*

*In this manual, the term “audio model” refers to any CrossPoint 450 Plus or MAV Plus switcher that switches audio.*

All audio models, with the exception of the MAV Plus 128 AV RCA, input and output audio on 3.5 mm, 5-pole captive screw terminals.

The MAV Plus 128 AV RCA inputs and outputs audio on RCA connectors.

For all switchers with video and audio, the audio switching can either be linked with the video (audio follow) or independent of the video (audio breakaway).

Adjustable input audio gain and attenuation compensates for level differences between audio inputs.

Each matrix switcher can be remotely controlled via its Ethernet port, its rear panel RS-232/RS-422 port, or its front panel Configuration (RS-232) port (matrix sizes up to 1616 only). The matrix switchers are programmed with Extron's Simple Instruction Set™ (SIS™), a set of basic ASCII code commands that provide simple control through a control system or PC without programming long, obscure strings of code. SIS commands can be entered via either the Ethernet link or either serial link.

The Ethernet port can be connected through a local area network (LAN) or wide area network (WAN).

The CrossPoint 450 Plus or MAV Plus switcher features e-mail notification of maintenance or other concerned personnel concerning the status of the power supplies and fans and the loss or resumption of sync on individual inputs.

The Ethernet port or either serial port can be connected to a control system, a PC, or Extron's MKP 2000 or MKP 3000 remote control panel.

The matrix switchers are housed in rack-mountable, metal enclosures with 19" rack ears. The amount of vertical rack space required for each switcher is as follows:

- 2U high enclosure
  - MAV Plus 88 and 128 HDA, HD, SVA, and SV switchers
  - MAV Plus 88, 128, 816, 164 (audio only), 168, 1212, and 1616 AV, AV RCA, V, and A switchers
- 3U high enclosure
  - CrossPoint 450 Plus 84, 88, 124, and 128 HV and HVA switchers
  - MAV Plus 168, 816, 1212, and 1616 SVA and SV switchers
- 4U high enclosure
  - MAV Plus 168, 816, and 1616 HDA and HD switchers
- 5U high enclosure
  - MAV Plus 2412, 2424, 3216, and 3232 SV, AV, V, and A switchers
- 6U high enclosure
  - CrossPoint 450 Plus 816, 168, and 1212, 1616 HV and HVA switchers
- 8U high enclosure
  - CrossPoint 450 Plus 2412 and 2424 HV and HVA switchers
  - MAV Plus 2412, 2424, 3216, and 3232 SVA switchers
- 10U high enclosure
  - CrossPoint 450 Plus 3216 and 3232 HV and HVA switchers

The appropriate rack mounting kit is included with each switcher.

---

Each model has an internal 100 VAC to 240 VAC, 50/60 Hz, auto switchable power supply that provides worldwide power compatibility. The CrossPoint 450 Plus 2412, 2424, 3216, and 3232 and MAV Plus 2412, 2424, 3216, and 3232 each have two, primary and redundant, power supplies. The power ratings of the power supplies for the various switchers are as follows:

- 20 watts
  - MAV Plus 128 AV RCA
  - MAV Plus 88 and 128
- 30 watts
  - CrossPoint 450 Plus 84, 88, 124, and 128
  - MAV Plus 816, 168, 1212, and 1616
  - MAV Plus 164 A
- 36 watts
  - CrossPoint 450 Plus 816, 168, 1212, and 1616
- 100 watts
  - MAV Plus 2412 and 3216
- 120 watts
  - MAV Plus 2424 and 3232
- 150 watts
  - CrossPoint 450 Plus 2412 and 3216
- 180 watts
  - CrossPoint 450 Plus 2424 and 3232

### **CrossPoint 450 Plus switchers**

There are 12 CrossPoint 450 Plus series matrix sizes available, each in an HVA (RGBHV video and audio) and HV (RGBHV video only) model:

- CrossPoint 450 Plus 84 (8 inputs by 4 outputs)
- CrossPoint 450 Plus 88 (8 inputs by 8 outputs)
- CrossPoint 450 Plus 816 (8 inputs by 16 outputs)
- CrossPoint 450 Plus 124 (12 inputs by 4 outputs)
- CrossPoint 450 Plus 128 (12 inputs by 8 outputs)
- CrossPoint 450 Plus 168 (16 inputs by 8 outputs)
- CrossPoint 450 Plus 1212 (12 inputs by 12 outputs)
- CrossPoint 450 Plus 1616 (16 inputs by 16 outputs)
- CrossPoint 450 Plus 2412 (24 inputs by 12 outputs)
- CrossPoint 450 Plus 2424 (24 inputs by 24 outputs)
- CrossPoint 450 Plus 3216 (32 inputs by 16 outputs)
- CrossPoint 450 Plus 3232 (32 inputs by 32 outputs)

The CrossPoint 450 Plus Series have a minimum bandwidth of 425 MHz (-3 dB). All models can also switch RGBS, RGSB, RsGsBs, HDTV, component video, S-video, and composite video.

### MAV Plus switchers

There are 61 different MAV Plus models available, in a combination of matrix sizes and low resolution video formats, with or without audio or with audio only. The various matrix sizes and video formats are as follows:

- MAV Plus 88 (8 inputs by 8 outputs)
  - HDA (component/HDTV video and audio)
  - HD (component/HDTV video only)
  - SVA (S-video and audio)
  - SV (S-video only)
  - AV (composite video and audio)
  - V (composite video only)
  - A (audio only)
- MAV Plus 128 (12 inputs by 8 outputs)
  - HDA           ○ HD
  - SVA           ○ SV
  - AV           ○ V           ○ A
- MAV Plus 128 AV RCA (12 inputs by 8 outputs)
  - AV (with RCA audio connectors)
- MAV Plus 816 (8 inputs by 16 outputs)
  - HDA           ○ HD
  - SVA           ○ SV
  - AV           ○ V           ○ A
- MAV Plus 164 (16 inputs by 4 outputs)
  - A
- MAV 168 Plus (16 inputs by 8 outputs)
  - SVA           ○ SV
  - AV           ○ V           ○ A
- MAV 1212 Plus (12 inputs by 12 outputs)
  - SVA           ○ SV
  - AV           ○ V
- MAV 1616 Plus (16 inputs by 16 outputs)
  - HDA           ○ HD
  - SVA           ○ SV
  - AV           ○ V           ○ A
- MAV 2412 Plus (24 inputs by 12 outputs)
  - SVA           ○ SV
  - AV           ○ V           ○ A
- MAV 2424 Plus (24 inputs by 24 outputs)
  - SVA           ○ SV
  - AV           ○ V           ○ A

- 
- MAV 3216 Plus (32 inputs by 16 outputs)
    - SVA           ○ SV
    - AV           ○ V           ○ A
  - MAV 3232 Plus (32 inputs by 32 outputs)
    - SVA           ○ SV
    - AV           ○ V           ○ A

MAV Plus HDA and HD switchers can also route low resolution RGB and RsGsBs video signals. HDA and HD switchers can also route multiple composite video planes or S-video and composite video. If used in this way, the various video planes cannot be broken away; the input signals on the Y, R-Y, and B-Y input BNCs must be routed to the same outputs.

MAV Plus SVA and SV switchers can also be used to switch two planes of composite video. If used in this way, the two video planes cannot be broken away; the input signals on the luma and chroma input BNCs must be routed to the same outputs.

The MAV Plus Series have a bandwidth of 150 MHz (-3 dB).

## Definitions

The following terms, which apply to Extron matrix switchers, are used throughout this manual:

**Tie** — An input-to-output connection.

**Set of ties** — An input **typed** to two or more outputs. (An output can never be tied to more than one input.)

**Configuration** — One or more **ties** or one or more **sets of ties**.

**Current configuration** — The **configuration** that is currently active in the switcher (also called **configuration 0**)

**Global memory preset** — A **configuration** that has been stored. Up to 32 **global memory presets** can be stored in memory. Preset locations are assigned to the input buttons and (where necessary) output buttons. Up to 20 or 32 (depending on the number of input and output buttons) presets can be selected from the front panel for either saving or retrieving. When a **preset** is retrieved from memory, it becomes the **current configuration**. All models have 32 presets; on models with fewer than 32 input and output buttons, preset numbers that are too high to be available from the front panel are still accessible under serial port or Ethernet control.

### Features

**Video** — All switchers input and output video on BNC connectors.

**CrossPoint 450 Plus** — These switchers input and output ultra-wideband RGBHV or RGBS video. They can also switch RGsB, RsGsBs, component/HDTV, S-video, or composite video.

**MAV Plus** — These switchers input and output NTSC 3.58, NTSC 4.43, PAL, or SECAM video or HDTV video inputs. Depending on the video format of the switcher, these switchers can distribute low resolution RGsB, RsGsGs, component/HDTV, S-video, or composite video.

**Bandwidth** —

**CrossPoint 450 Plus** — The CrossPoint 450 Plus Series switchers provide a minimum of 425 MHz (-3 dB) video bandwidth, fully loaded.

**MAV Plus** — The MAV Plus switchers provide a minimum of 150 MHz (-3 dB) video bandwidth, fully loaded.

**Audio inputs (audio models only)** —

**All audio models, with the exception of the MAV Plus 128 AV RCA** — Input and output stereo audio, balanced or unbalanced, on 3.5 mm, 5-pole captive screw terminals.

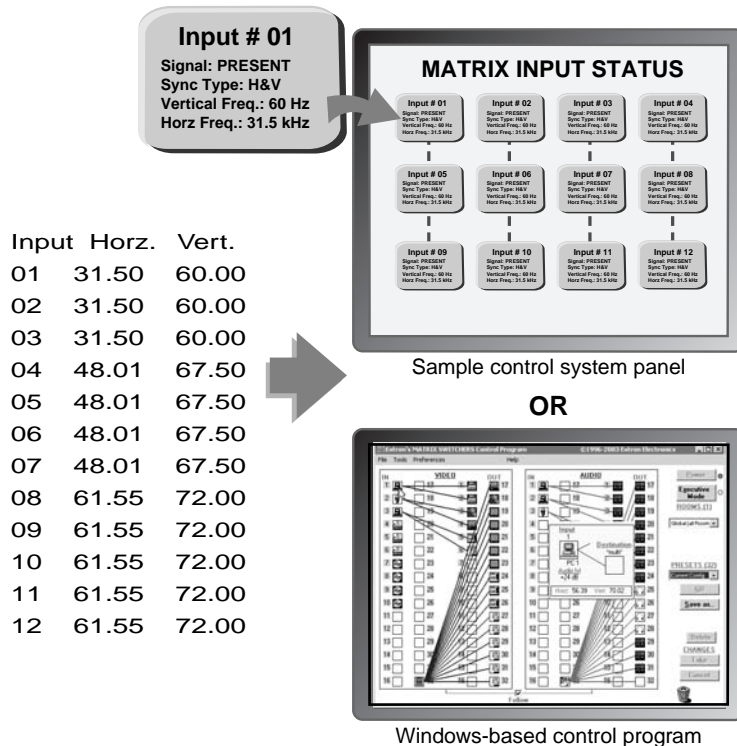
**MAV Plus 128 AV RCA** — Input and output unbalanced stereo audio on left and right RCA connectors.

**Audio input gain/attenuation (audio models only)** — Individual input audio levels can be adjusted so there are no noticeable volume differences between sources. Users can set the input level of audio gain or attenuation (-18 dB to +24 dB) via the Ethernet link, either serial port link, or the front panel.

**Audio output volume (audio models)** — The audio volume of each output can be displayed and adjusted through a range of full output to completely silent from the front panel or under serial port or Ethernet control.

**Digital Sync Validation Processing (DSVP™) (CrossPoint 450 Plus switchers) —**

In critical environments or unmanned, remote locations, it may be vital to know that sources are active and switching. Extron's DSVP confirms that input sources are active by scanning all sync inputs for active signals. DSVP provides instantaneous frequency feedback for composite sync or separate horizontal and vertical sync signals via the switcher's serial ports or Ethernet port. The frequency information can be displayed on any control system or in a Windows®-based control program on a local-area network (LAN) or Internet (IP) connection (figure 1-3).



**Figure 1-3 — DSVP data display**

**Rooming** — Each switcher can be programmed to group multiple outputs to specific “rooms”, allowing them to have their own presets.

**Switching flexibility** — Provides individually buffered, independent matrix switched outputs with audio follow and audio breakaway for audio models.

- **Tie any input to any or all outputs**
- **Quick multiple tie** — Multiple inputs can be switched to multiple outputs simultaneously. This allows all displays (outputs) to change from source to source at the same time.
- **Audio follow** — Audio can be switched with its corresponding video input via front panel control or under Ethernet or serial port remote control.
- **Audio breakaway** — Audio can be broken away from its corresponding video signal. This feature allows any audio signal to be selected with any video signal simultaneously to one or all outputs in any combination. Audio breakaway switching can be done via front panel control or under Ethernet or serial port remote control.



## Introduction, cont'd

---

**Operational flexibility** — Operations such as input/output selection, setting of presets, and adjustment of audio levels can be performed on the front panel or via the Ethernet or serial link. The serial links allow remote control via a PC or control system. The Ethernet link allows multiple remote links with two levels of password protection.

- **Front Panel Controller** — The front panel controller supports input and output selection, I/O grouping, preset creation and selection, RGB delay, and audio gain and attenuation and volume control (audio models). The front panel features illuminated pushbuttons that can be labeled with text or graphics.
- **Windows-based control program** — For serial port or Ethernet remote control from a PC, the Extron Windows-based control software provides a graphical interface and drag-and-drop/point-and-click operation. The Windows-based control program also has an emulation mode that lets you create a switcher configuration file at the home office and then download it for use by the switcher on site.
- **Simple Instruction Set (SIS™)** — The remote control protocol uses Extron's SIS for easy programming and operation.
- **Remote control panels and keypads** — The matrix switchers are remote controllable, using the optional MKP 2000 and MKP 3000 remote control keypads. The remote control devices are easy to use and provide tactile buttons for quick selection. Each MKP can be used for input-to-output switching, one-touch switching for a particular output. The MKP 3000 also can be used for selection of global presets.

**Upgradeable firmware** — The firmware that controls all switcher operation can be upgraded in the field via either serial port or the Ethernet port, without taking the switcher out of service. Firmware upgrades are available for download on the Extron Web site, [www.extron.com](http://www.extron.com) and they can be installed using the Windows-based control program or built-in HTML pages.

**Labeling** — Extron's button label software lets you create labels to place in the front panel I/O buttons, with names, alphanumeric characters, or color bitmaps for easy and intuitive input and output selection. Alternatively, labels can be made with any Brother™ P-Touch™ or comparable labeler.

**Global memory presets** — 20 or 32 (depending on the model) global memory presets are a time-saving feature that lets you set up and store input/output configurations in advance. You can then recall those configurations, when needed, with a few simple steps.

**Rack mounting** — Rack mountable in any conventional 19" wide rack.

**Three front panel security lockout modes (Executive modes)** — If a matrix switcher is installed in an open area, where operation by unauthorized personnel may be a problem, either of two security lockout modes can be implemented (the third mode is unlocked). When a front panel locked mode is enabled, a special button combination or SIS command is required to unlock the front panel controller and make the front panel fully operational.

**I/O grouping** — Allows the matrix to be virtually divided into smaller sub-switchers, making installation and control easier. I/O grouping limits the selection of inputs and outputs to members of the same group. I/O grouping allows specific outputs, such as those designated for a specific purpose, to be grouped together.

---

**Power** — The matrix switchers' 100 VAC to 240 VAC, internal power supply(s) provides worldwide power compatibility.

**Primary and redundant power supplies** —  
(CrossPoint 450 Plus and MAV Plus 2412, 2424, 3216, and 3232 switchers only)  
Includes two internal 100 VAC to 240 VAC, 50/60 Hz, auto-switchable power supplies, which provide worldwide power compatibility.

The power supply circuitry is configured to automatically switch over from the primary supply to the hot redundant supply in the case of a failure.

The hot redundant power supply means high reliability for the system and no loss of functionality should the primary supply fail; the redundant power supply immediately assumes the load.

**Power supply status LEDs** —  
(CrossPoint 450 Plus and MAV Plus 2412, 2424, 3216, and 3232 switchers only)  
Front panel LEDs indicate the status of the primary and redundant power supplies.

## Introduction, cont'd

---

*This page was intentionally left blank.*



# CrossPoint 450 Plus and MAV Plus Switchers

# Chapter Two

## Installation

Mounting the Switcher

Rear Panel Views

Rear Panel Connections

Front Panel Configuration Port (Matrix Sizes up to 1616 Only)

# Installation

---

## Mounting the Switcher

The matrix switchers are housed in rack-mountable, metal enclosures with 19" rack ears. The amount of vertical rack space required for each switcher is as follows:

- 2U high enclosure
  - MAV Plus 84, 88, 124, and 128 HDA and HD
  - MAV Plus 84, 88, 124, 128, and 1212 SVA, and SV
  - MAV Plus 84, 88, 124, 128, 816, 1212, 168, and 1616 AV, AV RCA, V, and A
  - MAV Plus 164 A
- 3U high enclosure
  - CrossPoint 450 Plus 84, 88, 124, and 128 HV and HVA
  - MAV Plus 168, 816, and 1616 SVA and SV
- 4U high enclosure
  - MAV Plus 168, 816, and 1616 HDA and HD
- 5U high enclosure
  - MAV Plus 2412, 2424, 3216, 3232 AV, V, and A
- 6U high enclosure
  - CrossPoint 450 Plus 816, 168, and 1616 HV and HVA
- 8U high enclosure
  - CrossPoint 450 Plus 2412 and 2424 HV and HVA
- 10U high enclosure
  - CrossPoint 450 Plus 3216 and 3232 HV and HVA

## UL requirements

The following Underwriters Laboratories (UL) requirements pertain to the installation of the matrix switcher into a rack (figure 2-1).

1. **Elevated operating ambient temperature** — If installed in a closed or multi-unit rack assembly, the operating ambient temperature of the rack environment may be greater than room ambient. Therefore, consider installing the equipment in an environment compatible with the maximum 122 °F (50 °C) (CrossPoint 450 Plus) or 113 °F (45 °C) (MAV Plus) ambient temperature (T<sub>ma</sub>) specified by Extron.
2. **Reduced air flow** — Installation of the equipment in a rack should be such that the amount of air flow required for safe operation of the equipment is not compromised.
3. **Mechanical loading** — Mounting of the equipment in the rack should be such that a hazardous condition is not achieved due to uneven mechanical loading.
4. **Circuit overloading** — Consideration should be given to the connection of the equipment to the supply circuit and the effect that overloading of the circuits might have on overcurrent protection and supply wiring. Appropriate consideration of equipment nameplate ratings should be used when addressing this concern.
5. **Reliable earthing (grounding)** — Reliable earthing of rack-mounted equipment should be maintained. Particular attention should be given to supply connections other than direct connections to the branch circuit (e.g. use of power strips).

## Mounting instructions

1. Insert the switcher into the rack, aligning the holes in the mounting bracket with those in the rack.

- Secure the switcher to the rack using the supplied bolts.

## Rear Panel Views

All connectors for all switchers are on the rear panel. Figure 2-1 through figure 2-10 show a representative sampling of all of the matrix switchers described in this manual. See “Connections”, on page 2-8, for connecting cables to the rear panel connectors.

**CAUTION** Use Electrostatic discharge precautions (be electrically grounded) when making connections. Electrostatic discharge (ESD) can damage equipment, even if you cannot feel, see, or hear it.

**CAUTION** Remove system power before making all connections.

## CrossPoint 450 Plus switchers

Figure 2-1 shows the CrossPoint 450 Plus 3232 HVA RGB video and stereo audio matrix switcher.

**NOTE** The CrossPoint 450 Plus 2412, 2424, and 3216 are housed in the same 10U or similar 8U enclosure, but have fewer output connectors to accommodate their smaller matrix sizes.

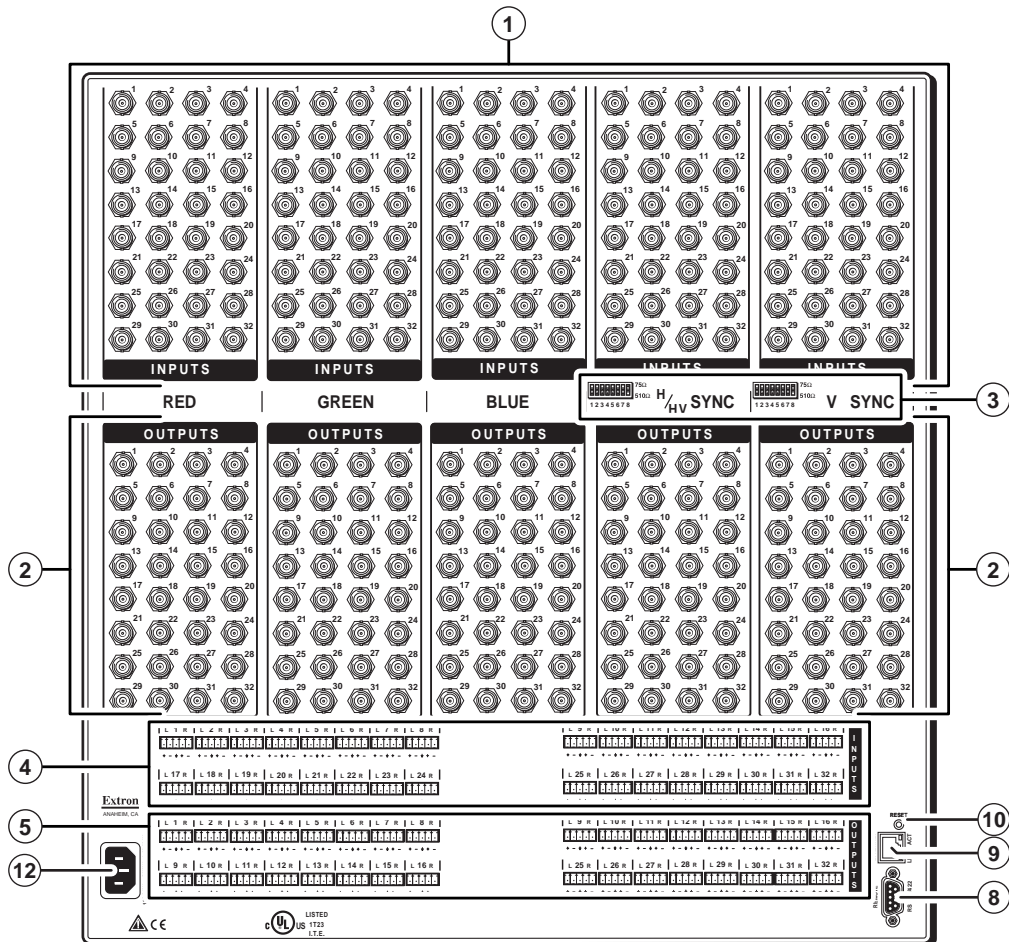
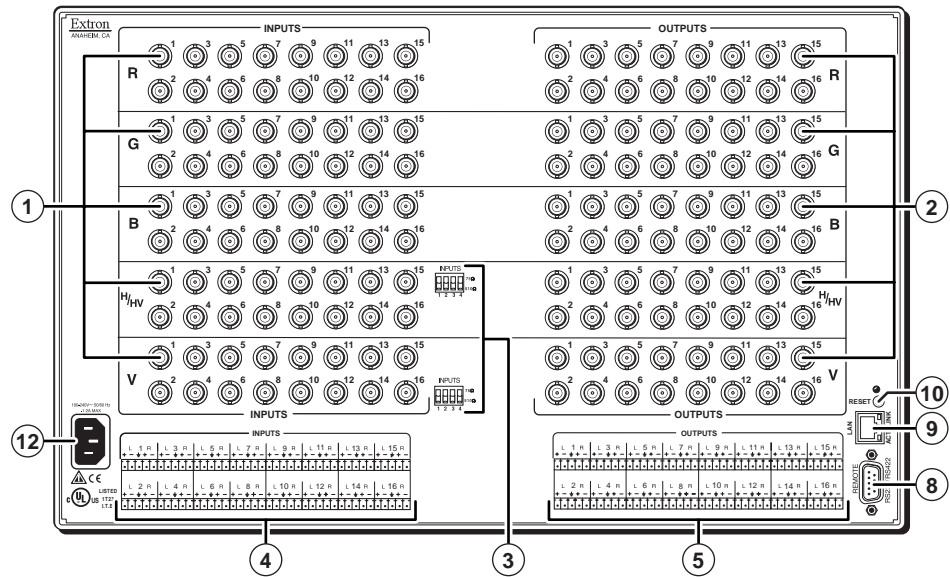


Figure 2-1 — CrossPoint 450 Plus 3232 HVA matrix switcher

# Installation, cont'd

Figure 2-2 shows the CrossPoint 450 Plus 1616 HVA RGB video and stereo audio matrix switcher.

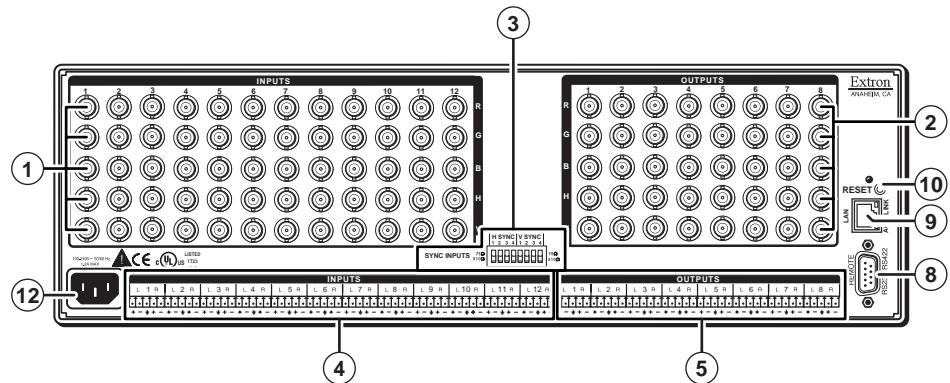
**NOTE** *The CrossPoint 450 Plus 816 and 168 are housed in the same 6U enclosure, but have fewer output connectors to accommodate their smaller matrix sizes.*



**Figure 2-2 — CrossPoint 450 Plus 1616 HVA matrix switcher**

Figure 2-3 shows the CrossPoint 450 Plus 128 HVA RGB video and stereo audio matrix switcher.

**NOTE** *The CrossPoint 450 Plus 84, 88, and 124 are housed in the same 3U enclosure, but have fewer output connectors to accommodate their smaller matrix sizes.*

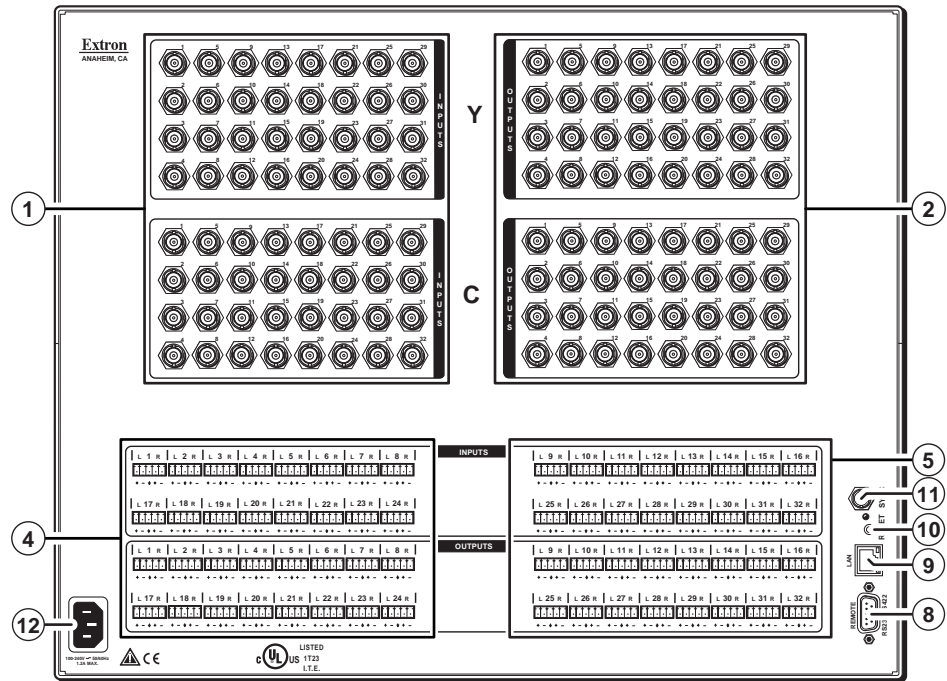


**Figure 2-3 — CrossPoint 450 Plus 128 HVA matrix switcher**

## MAV Plus switchers

Figure 2-4 shows the MAV Plus 3232 SVA S-video and stereo audio switcher.

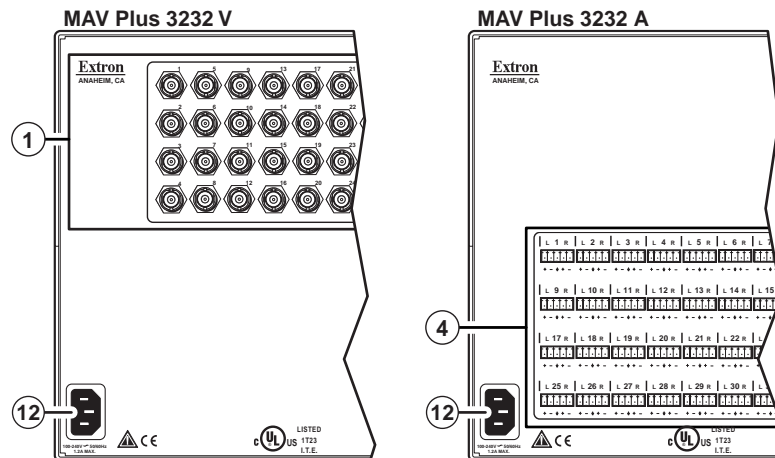
**NOTE** The MAV Plus 2412, 2424, and 3216 are housed in a similar 8U enclosure, but have fewer input and/or output connectors to accommodate their smaller matrix sizes.



**Figure 2-4 — MAV Plus 3232 SVA matrix switcher**

Figure 2-5 shows a portion of the MAV Plus 3232 V composite video matrix switcher without audio and a portion of the MAV Plus 3232 A audio-only matrix switcher.

**NOTE** Both of these switchers feature the same matrix size as figure 2-4, but with composite video format and without audio and in a 5U enclosure.



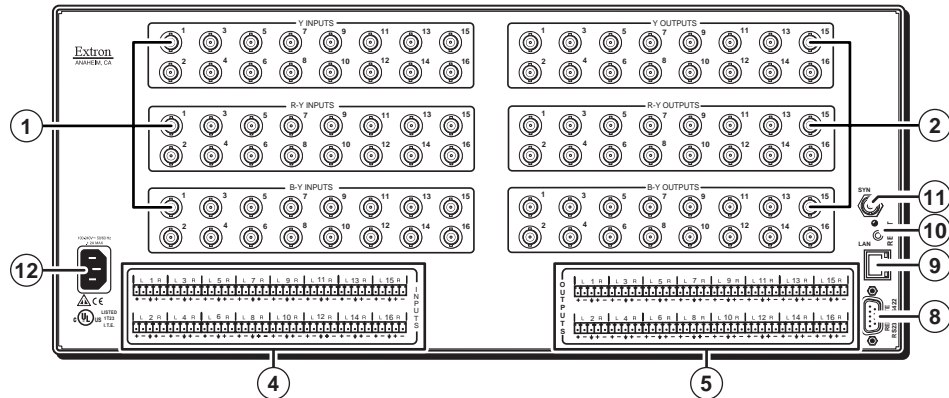
**Figure 2-5 — MAV Plus 3232 matrix switchers with various formats**



## Installation, cont'd

Figure 2-6 shows a MAV Plus 1616 HDA component/HDTV video and stereo audio switcher.

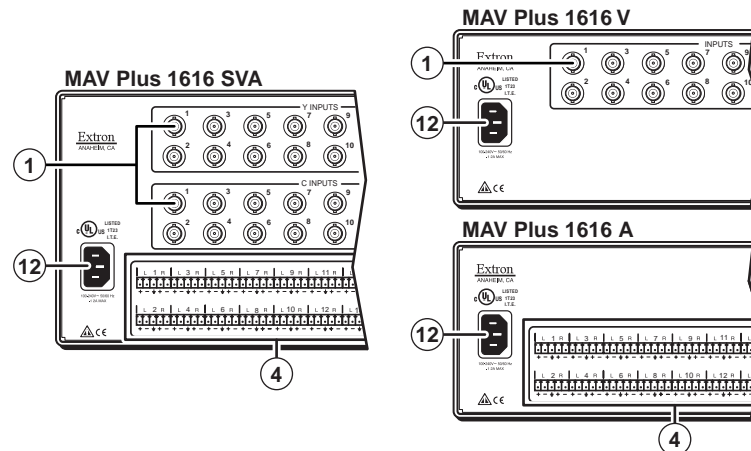
**NOTE** The rear panel of the MAV Plus 816 and 168 models have the same features as the MAV Plus 1616 series models (figure 2-6 and figure 2-7), with the exception of fewer inputs or outputs.



**Figure 2-6 — MAV Plus 1616 HDA matrix switcher**

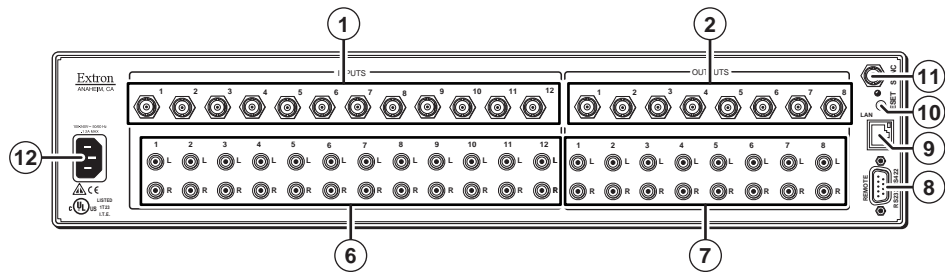
Figure 2-7 shows a portion of the MAV Plus 1616 SVA S-video and stereo audio matrix switcher, a portion of the MAV Plus 1616 V composite video matrix switcher without audio, and a portion of the MAV Plus 1616 A audio-only matrix switcher.

**NOTE** All of these switchers feature the same matrix size as figure 2-6, but with different video formats and with or without audio.



**Figure 2-7 — MAV Plus 1616 matrix switchers with various formats**

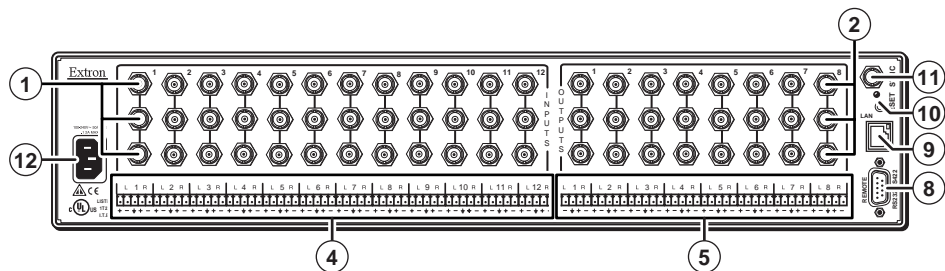
Figure 2-8 shows a MAV Plus 128 AV RCA composite video and stereo audio (with inputs and outputs on RCA connectors) matrix switcher.



**Figure 2-8 — MAV Plus 128 AV RCA matrix switcher**

Figure 2-9 shows a MAV Plus 128 HDA component/HDTV video and stereo audio matrix switcher.

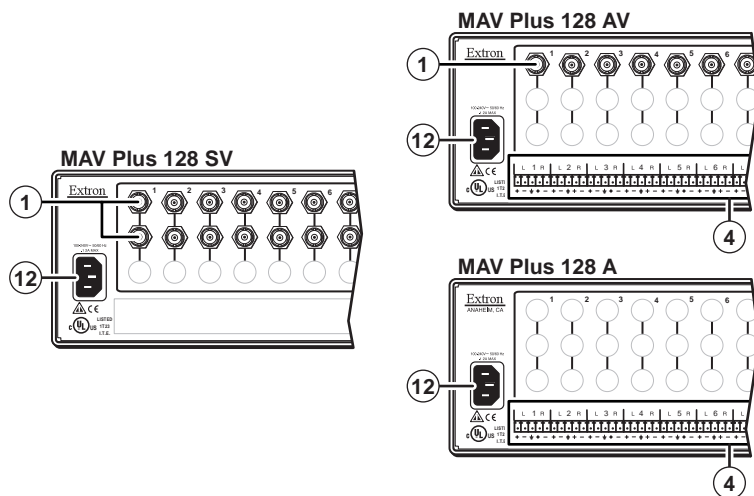
**NOTE** The MAV Plus 88 models are housed in the same 2U enclosure, but have fewer input and/or output connectors to accommodate the different matrix sizes they provide.



**Figure 2-9 — MAV Plus 128 HDA matrix switcher**

Figure 2-10 shows a portion of the MAV Plus 128 SV S-video matrix switcher without audio, a portion of the MAV Plus 128 AV composite video and stereo audio matrix switcher, and a portion of the MAV Plus 128 A audio-only matrix switcher.

**NOTE** All of these switchers feature the same matrix size as figure 2-9, but with different video formats and with or without audio.



**Figure 2-10 — MAV Plus 128 matrix switchers with various formats**

### Rear Panel Connections

**CAUTION** Use Electrostatic discharge precautions (be electrically grounded) when making connections. Electrostatic discharge (ESD) can damage equipment, even if you cannot feel, see, or hear it.

**CAUTION** Remove system power before making all connections.

### Video input and output (video switchers)

**NOTE** The switchers do not alter the video signal in any way. The signal output by the switcher is in the same format as the input.

#### RGBHV (CrossPoint 450 Plus switchers only)

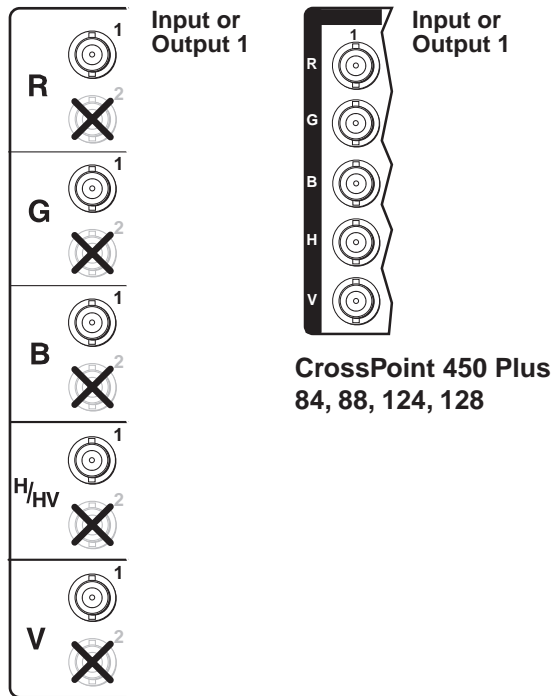
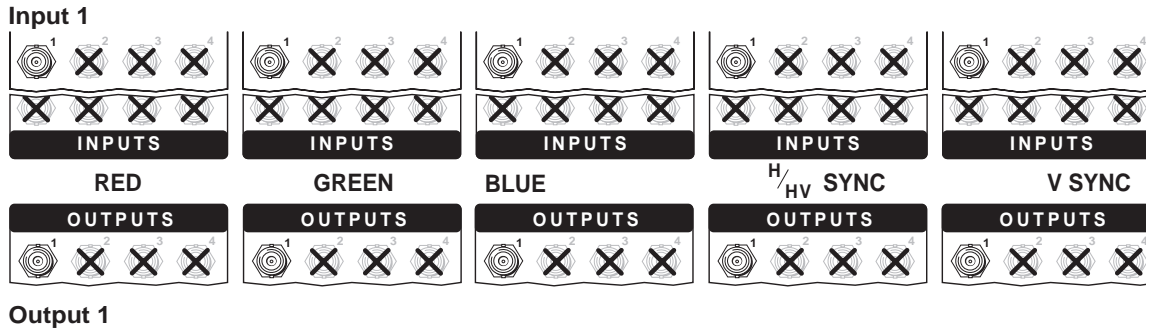
The switcher can connect to up to as many as 32 RGBHV video sources, depending on the model. The switcher can output to as many as 32 RGBHV video devices, depending on the model.

**NOTE** On CrossPoint 450 Plus matrix sizes of 8 x 16 and larger, the connectors for each video plane are grouped together (all of the red inputs grouped together, all of the green inputs grouped, and so on). Ensure that you connect the input on each video plane to the corresponding connector in the correct group (see figure 2-11).

**NOTE** The CrossPoint 450 Plus switchers can also switch RGBS, RGsB, RsGsBs, component video, S-video, or composite video by using four, three, two, or one BNC(s). If switching a video format other than RGBHV, ensure that the same video planes (R, G, B, H/HV, and/or V) are used on the switcher output as on the input.

- ① **Video inputs** — Connect RGB video, component/HDTV video, S-video, or composite video inputs, as applicable, to these BNC connectors for each input. Figure 2-11 shows how to connect the RGB video format to each configuration.
- ② **Video outputs** — Connect RGB video, component/HDTV video, S-video, or composite video displays, as applicable, or other devices to these BNC connectors for each output. Figure 2-11 shows how to connect the RGB video format to each configuration.

**CrossPoint 450 Plus**  
2412, 2424, 3216, 3232



**CrossPoint 450 Plus**  
816, 168, 1212, 1616

**Figure 2-11 — CrossPoint 450 Plus RGB connections**

## Installation, cont'd

### Video (MAV Plus switchers only)

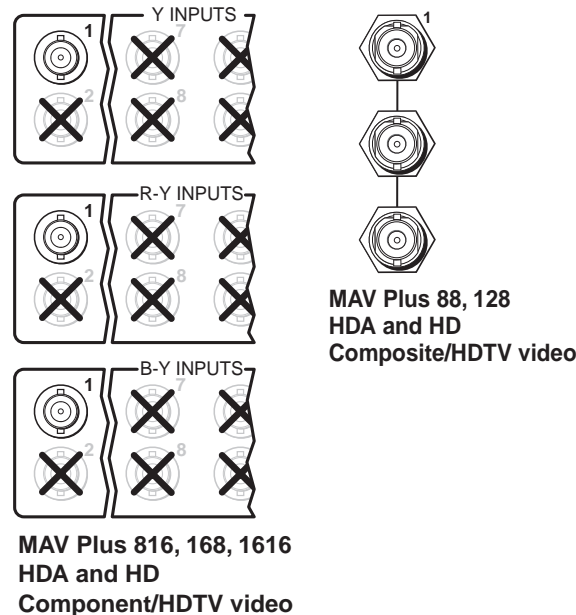
**NOTE** Video input and output connections are made with female BNC connectors. Some video input and output devices do not have BNC video output connectors. For these cases, a suitable cable or connector adapter is necessary. The part number for the Extron RCA-to-BNC adapter is **10-229-01**.

**NOTE** The connectors for each video plane are grouped together (for example, for component/HDTV switchers, all of the Y inputs grouped together, all of the R-Y inputs grouped, and so on). Ensure that you connect the input on each video plane to the corresponding connector in the correct group (figure 2-12, through figure 2-14, below and on the next page).

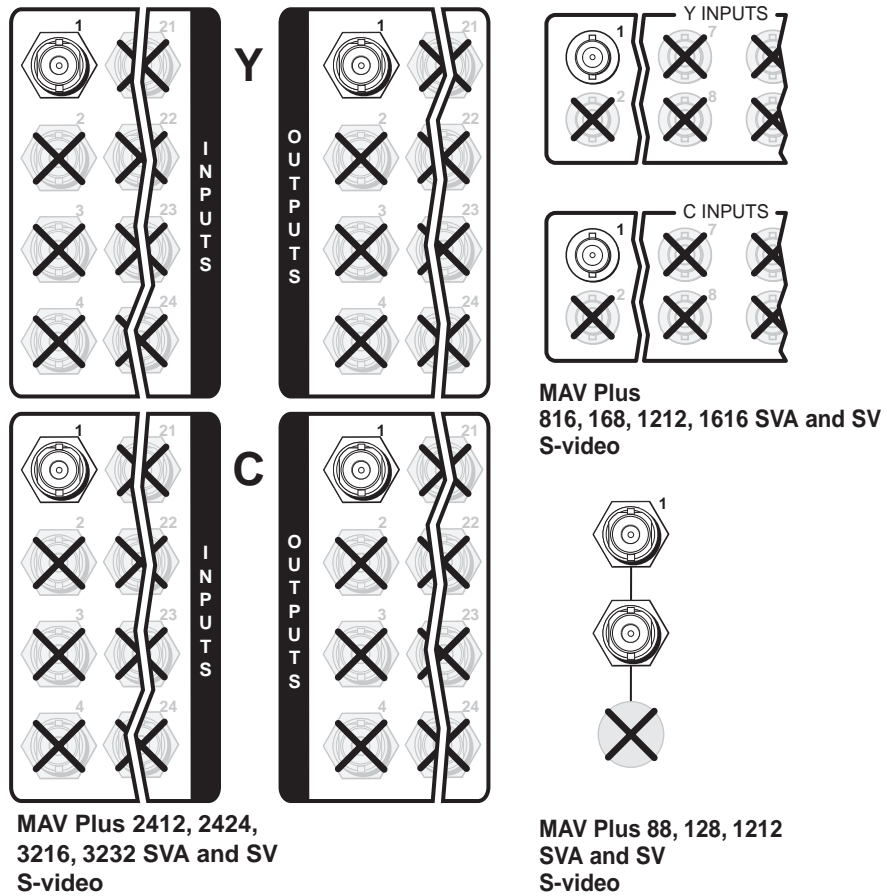
The switcher can connect to up to as many as 32 S-video or composite video or up to 16 component/HDTV video, S-video, or composite video sources, depending on the model. The switcher can output to as many as 32 S-video or composite video or up to 16 component video, S-video, or composite video devices, depending on the model.

- 1 **Video inputs** — Connect component/HDTV video (figure 2-12), S-video (figure 2-13), or composite video (figure 2-14) inputs, as applicable, to these BNC connectors for each input.
- 2 **Video outputs** — Connect component/HDTV video (figure 2-12), S-video (figure 2-13), or composite video (figure 2-14) displays, as applicable, or other devices to these BNC connectors for each output. Figure 2-14 shows how to connect the various video formats to each MAV Plus configuration.

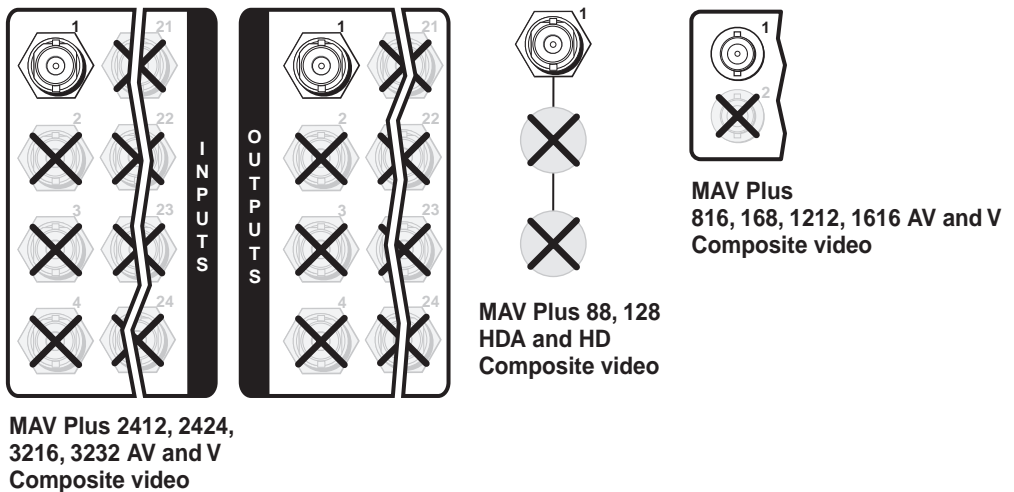
**NOTE** The S-video (figure 2-13) and composite video (figure 2-14) connection drawings are all on the next page.



**Figure 2-12 — MAV Plus component/HDTV video connections**



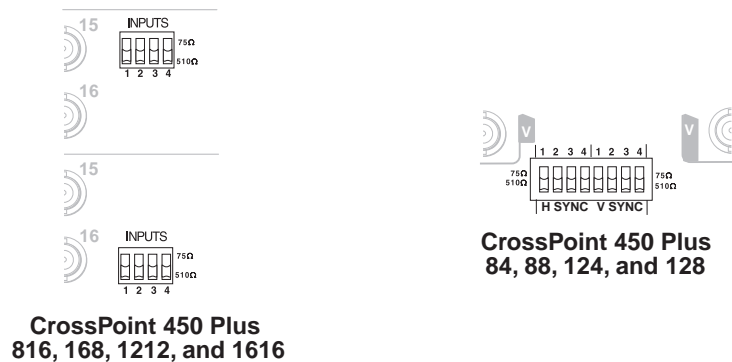
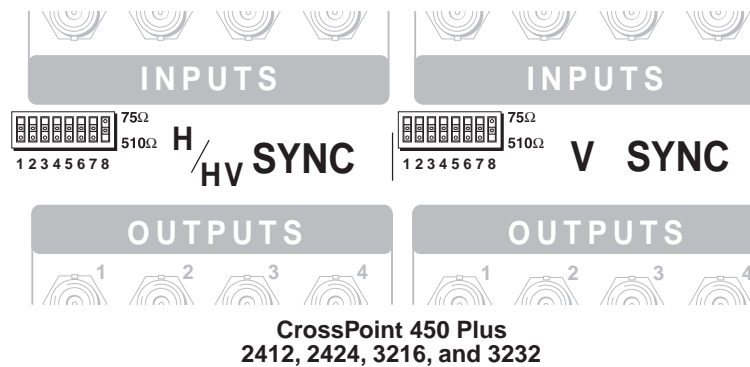
**Figure 2-13 — MAV Plus S-video connections**



**Figure 2-14 — MAV Plus video connections**

## Sync termination switches (CrossPoint 450 Plus only)

- ③ **Sync termination switches** — The CrossPoint 450 Plus matrix switchers have sync termination switches on the rear panel for inputs 1 through 8 (CrossPoint 450 Plus 2412, 2424, 3216, and 3232) or inputs 1 through 4 (CrossPoint 450 Plus 84, 88, 124, 128, 816, 168, 1212, 1616). The switches (figure 2-15) provide a way to condition non-TTL sync levels greater than 5 Vp-p, enabling the sync to be properly passed from input to selected output(s). The matrix switchers have two sets of sync termination switches; one for horizontal or combined sync and a second set for vertical sync.



**CrossPoint 450 Plus  
816, 168, 1212, and 1616**

**Figure 2-15 — Sync termination switches**

Each switch provides the option of selecting either 510 ohms or 75 ohms. The 75 ohms position is required only for an input with non-TTL sync, greater than 5 V p-p. The normal position is 510 ohms.

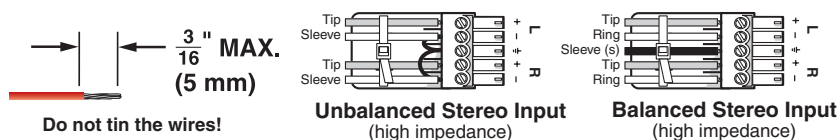
**NOTE** *An input that produces an out of sync display, a display that is rolling vertically and/or tearing horizontally, could indicate a non-TTL sync input. A device that is known to output non-TTL sync levels (greater than 5V p-p) should be connected to one of the inputs with sync termination switches, and the switches for that input should be set to the 75 ohm position. If you are not sure, check the specifications in the user's manual for the input device.*

## Audio input and output (models with audio only)

By default, the audio ties follow the video ties. Audio breakaway, which can be activated via the front panel or under Ethernet or serial port control, allows you to select from any one of the audio input sources and route it separately from its corresponding video source. See chapter 3, “Operation”, chapter 4, “Programmer’s Guide”, chapter 5, “Matrix Software”, and chapter 6, “HTML Operation” for details.

### Captive screw connector models (all except MAV Plus 128 AV RCA)

- ④ **Connections for balanced and unbalanced audio inputs** — Each input has a 3.5 mm, 5-pole captive screw connector for balanced or unbalanced stereo audio input. Connectors are included with each switcher, but you must supply the audio cable. See figure 2-16 to wire a connector for the appropriate input type. Use the supplied tie-wrap to strap the audio cable to the extended tail of the connector. High impedance is generally over 800 ohms.

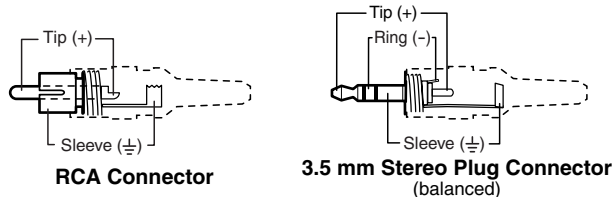


**Figure 2-16 — Captive screw connector wiring for audio inputs**

**CAUTION** The length of the exposed (stripped) portion of the copper wires is important. The ideal length is 3/16" (5 mm). Longer bare wires can short together. Shorter bare wires are not as secure in the direct insertion connectors and could be pulled out.

**CAUTION** The captive screw audio connector can easily be inadvertently plugged partially into one receptacle and partially into an adjacent receptacle. This misconnection could damage the audio output circuits. Ensure that the connector is plugged fully and only into the desired input or output.

**NOTE** See figure 2-17 to identify the tip, ring, and sleeve when you are making connections for the switcher from existing audio cables. A mono audio connector consists of the tip and sleeve. A stereo audio connector consists of the tip, ring and sleeve. The ring, tip, and sleeve wires are also shown on the captive screw audio connector diagrams, figure 2-16 and figure 2-18.



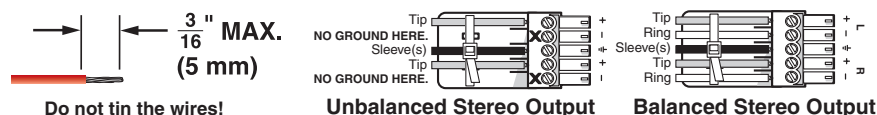
**Figure 2-17 — Typical audio connectors**

The audio level for each input can be individually set via the front panel or Ethernet or serial port control to ensure that the level on the output does not vary from input to input. See chapter 3, “Operation”, chapter 4, “Programmer’s Guide”, chapter 5, “Matrix Software”, and chapter 6, “HTML Operation” for details.



## Installation, cont'd

- ⑤ **Connections for balanced and unbalanced audio outputs** — These 3.5 mm, 5-pole captive screw connectors output the selected unamplified, line level audio. Connect audio devices, such as an audio amplifier or powered speakers. See figure 2-18 to properly wire an output connector. Use the supplied tie-wrap to strap the audio cable to the extended tail of the connector.



**Figure 2-18 — Captive screw connector wiring for audio output**

**CAUTION** Connect the sleeve to ground (Gnd). Connecting the sleeve to a negative (-) terminal will damage the audio output circuits.

**CAUTION** The length of the exposed (stripped) portion of the copper wires is important. **The ideal length is 3/16" (5 mm).** Longer bare wires can short together. Shorter bare wires are not as secure in the direct insertion connectors and could be pulled out.

The volume level for each output can be individually set via the front panel or Ethernet or serial port control. See chapter 3, “Operation”, chapter 4, “Programmer’s Guide”, chapter 5, “Matrix Software”, and chapter 6, “HTML Operation” for details.

### RCA connector model (MAV Plus 128 AV RCA)

- ⑥ **Connections for unbalanced audio inputs** — Each input has a pair, left and right, of female RCA connectors for unbalanced stereo audio input.
- ⑦ **Connections for unbalanced audio outputs** — Each output has a pair, left and right, of female RCA connectors for unbalanced stereo audio output.

### RS-232/RS-422

- ⑧ **RS-232/RS-422 connector** — Connect a host device, such as a computer, touch panel control, or RS-232 capable PDA to the switcher via this 9-pin D connector for serial RS-232/RS-422 control (figure 2-19).

Pin	All Models		84 through 1616 Matrix Sizes		2412 through 3232 Matrix Sizes	
	RS-232	Function	RS-422	Function	RS-422	Function
1	—	Not used	—	Not used	TX+	Transmit data (+)
2	TX	Transmit data	TX-	Transmit data (-)	TX-	Transmit data (-)
3	RX	Receive data	RX-	Receive data (-)	RX+	Receive data (+)
4	—	Not used	—	Not used	RX-	Receive data (-)
5	Gnd	Signal ground	Gnd	Signal ground	Gnd	Signal Ground
6	—	Not used	—	Not used	—	Not used
7	—	Not used	RX+	Receive data (+)	—	Not used
8	—	Not used	TX+	Transmit data (+)	—	Not used
9	—	Not used	—	Not used	—	Not used

**Figure 2-19 — RS-232/RS-422 connector**

See chapter 4, “Programmer’s Guide”, for definitions of the SIS commands (serial commands to control the switcher via this connector) and chapter 5, “Matrix Software” for details on how to install and use the control software.

---

**NOTE** *The switcher can support either the RS-232 or RS-422 serial communication protocol, and operate at 9600, 19200, 38400, or 115200 baud rates. See “Selecting the rear panel Remote port protocol and baud rate” in chapter 3, “Operation”, to configure the RS-232/RS-422 port from the front panel.*

If desired, connect an MKP 2000 or MKP 3000 remote control panel to the switcher’s RS-232/RS-422 connector. Refer to the “MKP 2000 Remote Control Panel User’s Manual” or the “MKP 3000 Remote Control Panel User’s Manual” for details.

## Ethernet

- 9 **Ethernet port** — If desired, for IP control of the system, connect the matrix switcher to a PC or to an Ethernet LAN, via this RJ-45 connector. You can use a PC to control the networked switcher with SIS commands from anywhere in the world. You can also control the switcher from a PC that is either running Extron’s windows-based control program or that has downloaded HTML pages from the switcher.



**Ethernet connection indicators** — The Link and Act LEDs indicate the status of the Ethernet connection. The Link LED indicates that the switcher is properly connected to an Ethernet LAN. This LED should light steadily. The Act LED indicates transmission of data packets on the RJ-45 connector. This LED should flicker as the switcher communicates.

### Cabling and RJ-45 connector wiring

It is vital that your Ethernet cables be the correct cables, and that they be properly terminated with the correct pinout. Ethernet links use Category (CAT) 5e or CAT 6, unshielded twisted pair (UTP) or shielded twisted pair (STP) cables, terminated with RJ-45 connectors. Ethernet cables are limited to a length 328’ (100 m).

**NOTE** *Do not use standard telephone cables. Telephone cables will not support Ethernet or Fast Ethernet.*

*Do not stretch or bend cables. Transmission errors can occur.*

The cable used depends on your network speed. The switcher supports both 10 Mbps (10Base-T — Ethernet) and 100 Mbps (100Base-T — Fast Ethernet), half-duplex and full-duplex, Ethernet connections.

- 10Base-T Ethernet requires CAT 3 UTP or STP cable at minimum.
- 100Base-T Fast Ethernet requires CAT 5e UTP or STP cable at minimum.

The Ethernet cable can be terminated as a straight-through cable or a crossover cable and must be properly terminated for your application (figure 2-20).

- **Crossover cable** — Direct connection between the computer and the CrossPoint 450 Plus or MAV Plus switcher.
- **Patch (straight) cable** — Connection of the CrossPoint 450 Plus or MAV Plus switcher to an Ethernet LAN.

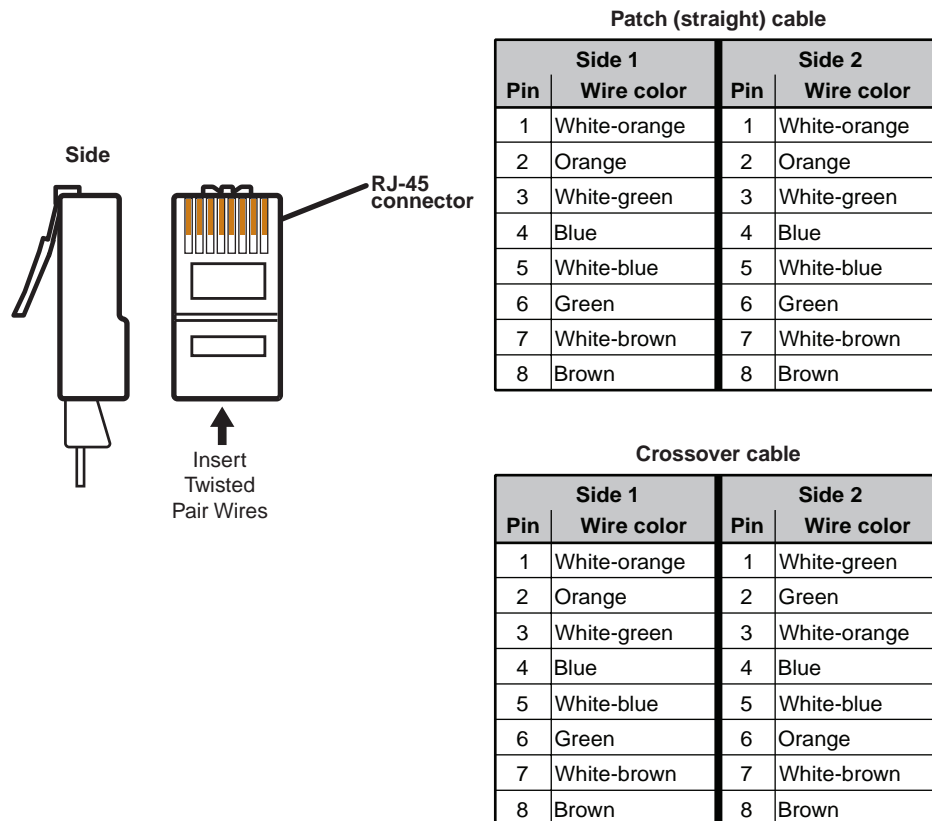


Figure 2-20 — RJ-45 connector and pinout tables

## Reset button

- ⑩ **Reset button** — The Reset button initiates four levels of reset to the matrix switcher. Press and hold the button while the switcher is running or while you power up the switcher for different reset levels.



See “Reset button” in chapter 3, “Operation”, for details.

- **Events (mode 3) reset** — Hold Reset for 3 seconds then release and push again to toggle events monitoring on and off.
- **IP settings (mode 4) reset** — Hold Reset for 6 seconds then release and push again to reset the switcher’s IP functions.

**NOTE** *IP settings reset does not replace any user-installed firmware.*

- **Absolute (mode 5) reset** — Hold Reset for 9 seconds then release and push again to restore the switcher to the default factory conditions.
- **Hard reset** — Hold Reset while powering up the switcher to restore the switcher to the default factory conditions.

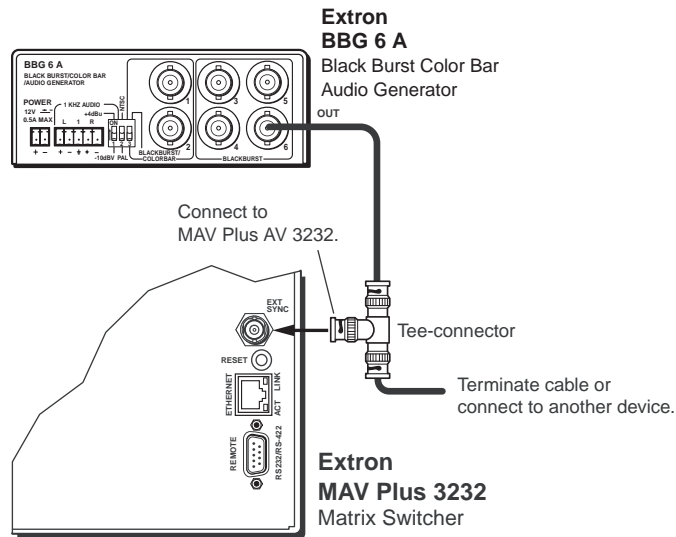
**NOTE** *Hard reset does not clear the current configuration.*

## External sync (MAV Plus video models only)

The MAV Plus switcher switches between inputs during the vertical interval period, resulting in glitch-free video switching. The MAV switcher can use an external signal to synchronize switching during the vertical interval. Without the external sync locking feature, switching between inputs can result in a brief rolling (sync loss) or a brief change in the picture size.

- 11 **Ext(ernal) Sync connector** — Connect an external sync signal to this BNC connection for genlocking the video signal in broadcast or other sync-critical applications.

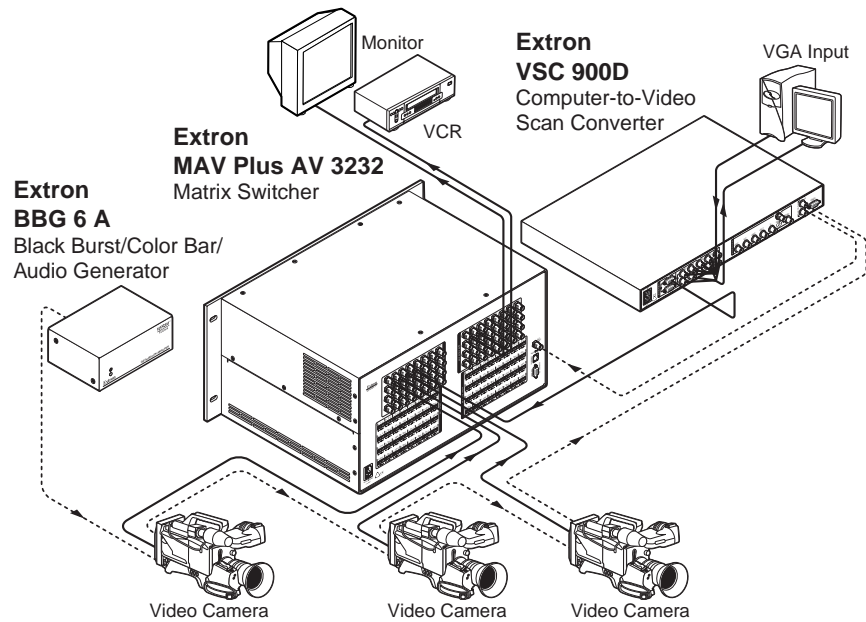
Figure 2-21 shows a basic external sync configuration. The Ext Sync connector receives the timing signal. A tee connector on the connector allows the signal to be passed on to another video device, if required. Terminate the tee connector if desired.



**Figure 2-21 — Simple external sync connection example**

Figure 2-22 shows another configuration, in which the timing source passes through three video cameras and a video scan converter before connecting to the switcher. This type of video camera is capable of synchronizing with the external timing source for video editing applications.

## Installation, cont'd



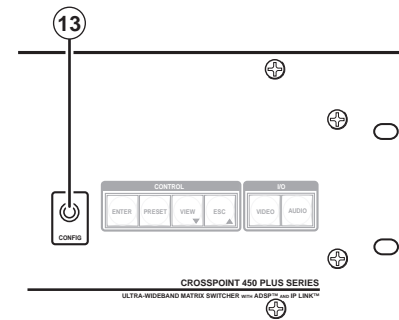
**Figure 2-22 — Multiple device external sync connection example**

If no external sync timing source is connected to the switcher, switching occurs immediately.

### Power

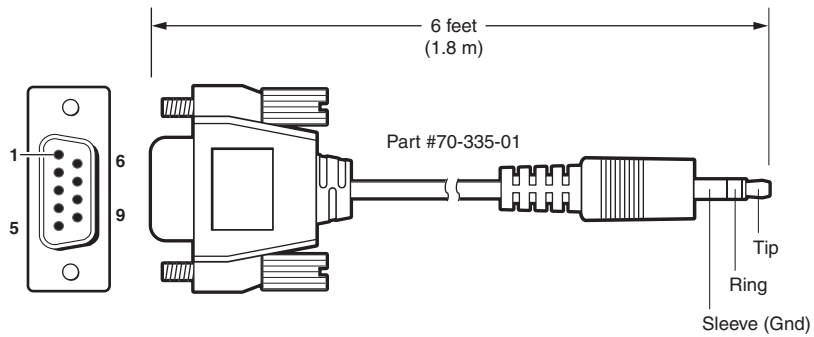
- ⑫ **AC power connector** — Plug a standard IEC power cord into this connector to connect the switcher to a 100 VAC to 240 VAC, 50 or 60 Hz power source.

### Front Panel Configuration Port (Matrix Sizes up to 1616 Only)



**Figure 2-23 — Front panel configuration port**

- ⑬ **Configuration port** — This 2.5 mm mini stereo jack serves the same serial communications function as the rear panel Remote port, but it is easier to access than the rear port after the matrix switcher has been installed and cabled. The optional 9-pin D to 2.5 mm mini jack TRS RS-232 cable, part #70-335-01 (figure 2-24), can be used for this connection.



9-pin D	Connection	TRS Plug
Pin 2	Computer's RX line	Tip
Pin 3	Computer's TX line	Ring
Pin 5	Computer's signal ground	Sleeve

**Figure 2-24 — Optional 9-pin TRS RS-232 cable**

**NOTE** This port is independent of the rear panel Remote port and is **not** affected by changes to the rear panel port's protocol. This front panel port's protocol can be changed, under SIS command control only. See the Command/Response table for IP SIS commands, in chapter 4, "Programmer's Guide", to configure all ports under SIS control.

**NOTE** A front panel Configuration port connection and a rear panel Remote port connection can both be active at the same time.

This port is RS-232 only, with its default protocols as follows:

- 9600 baud
- no parity
- 8 data bits
- 1 stop bit
- no flow control

**NOTE** The maximum distances from the matrix switcher to the controlling device can vary up to 200 feet (61 m). Factors such as cable gauge, baud rates, environment, and output levels (from the switcher and the controlling device) all affect transmission distance. Distances of about 50 feet (15 m) are typically not a problem. In some cases the matrix switcher may be capable of serial communications via RS-232 up to 250 feet (76 m) away.

## Installation, cont'd

---

*This page was intentionally left blank.*



# CrossPoint 450 Plus and MAV Plus Switchers

# 3 Chapter Three

## Operation

Front Panel Controls and Indicators

Front Panel Operations

Rear Panel Controls

Optimizing the Audio (Audio Switchers)

Troubleshooting

Configuration Worksheets



# Operation

**NOTE** The operation of the CrossPoint 450 Plus switchers and MAV Plus switchers is very similar. There are two exceptions:

- The video selection button is labeled “RGBHV” on the CrossPoint 450 Plus switchers and “Video” on the MAV Plus switchers.
- The MAV Plus switchers do not offer RGB delay switching.

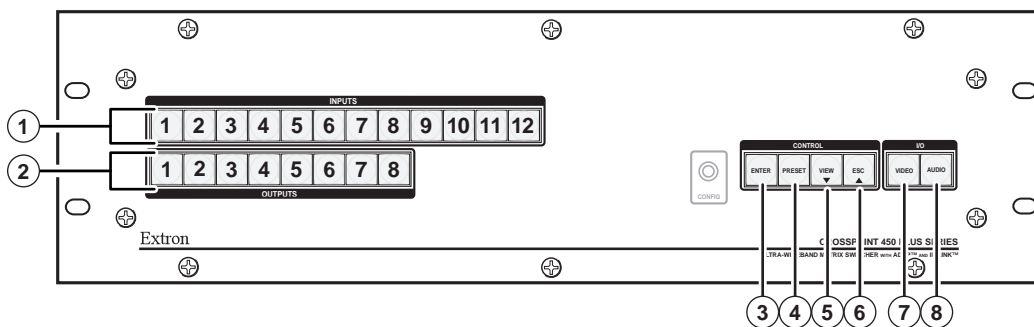
## Front Panel Controls and Indicators

The front panel controls (figure 3-1 through figure 3-3) are grouped into two sets. The input and output buttons are grouped on the left side of the control panel. The control buttons and video/audio (I/O) selection buttons are grouped on the right side of the panel.

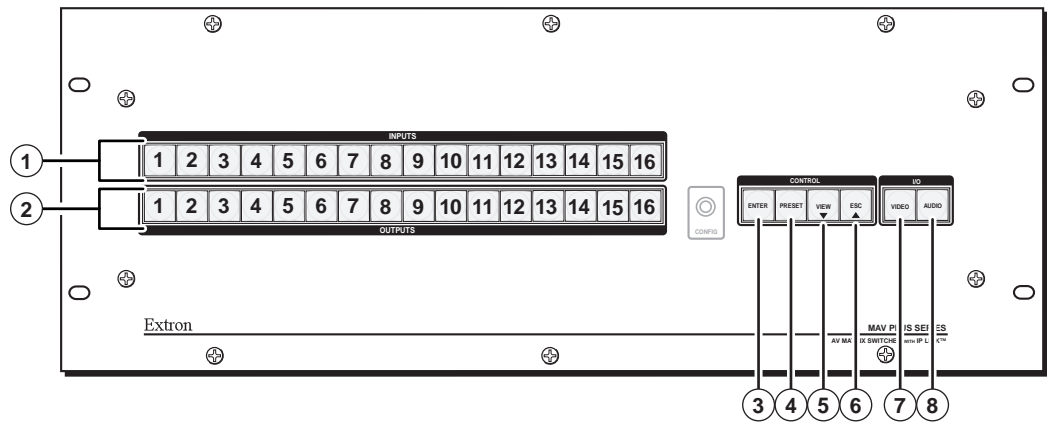
**NOTE** While the number of inputs and outputs varies depending on the size of the matrix, there are only three front panel arrangements: 12 input buttons by 8 output buttons (figure 3-1), 16 by 16 (figure 3-2), and 32 by 32 (figure 3-3). See the table below to identify the front panel arrangements used by each switcher model.

On smaller matrix switchers, the larger-numbered buttons are not used for input and output selection, although they are used to select and indicate preset numbers, indicate the input audio level, and indicate the output audio volume.

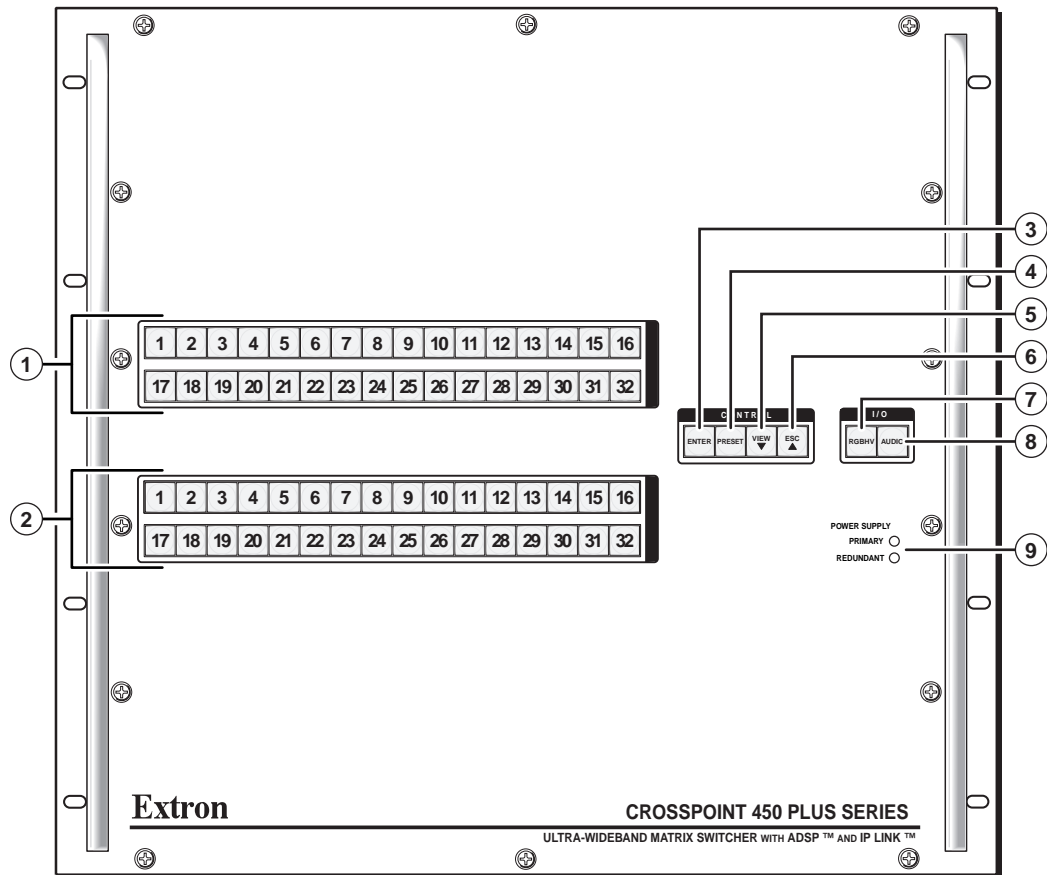
Switcher model	Panel			Figure
	12 x 8	16 x 16	32 x 32	
CrossPoint 450 Plus 84, 88, 124, 128 MAV Plus 88, 128	●			3-1
CrossPoint 450 Plus MAV Plus 816, 1212, 1616		●		3-2
CrossPoint 450 Plus MAV Plus 2412, 2424, 3216, 3232			●	3-3



**Figure 3-1 — Front panel, CrossPoint 450 Plus 128 HVA**



**Figure 3-2 — Front Panel, MAV Plus 1616 HDA**



**Figure 3-3 — CrossPoint 450 Plus 3232 series front panel**

The large, illuminated push buttons can be labeled with text and/or graphics. The buttons can be set to provide amber background illumination all the time or the background illumination can be turned off (see “Background illumination”, on page 3-50). The buttons blink or are lit at full intensity (depending on the operation) when selected.

### Definitions

The following terms, which apply to Extron matrix switchers, are used throughout this manual:

**Tie** — An input-to-output connection.

**Set of ties** — An input **typed** to two or more outputs. (An output can never be tied to more than one input.)

**Configuration** — One or more **ties** or one or more **sets of ties**.

**Current configuration** — The **configuration** that is currently active in the switcher (also called **configuration 0**)

**Global memory preset** — A **configuration** that has been stored. Up to 32 **global memory presets** can be stored in memory. Preset locations are assigned to the input buttons and (where necessary) output buttons. Up to 20 or 32 (depending on the number of input and output buttons) presets can be selected from the front panel for either saving or retrieving. When a **preset** is retrieved from memory, it becomes the **current configuration**. All models have 32 presets; on models with fewer than 32 input and output buttons, preset numbers that are too high to be available from the front panel are still accessible under serial port or Ethernet control.

**Room** — A subset of outputs that are logically related to each other, as determined by the operator. The switchers support up to 10 **rooms**, each of which can consist of from 1 to 16 outputs.

**Room memory preset** — A **configuration** consisting of outputs in a single **room** that has been stored. When a **room preset** is retrieved from memory, it becomes the **current configuration**.

### Input and output buttons

**NOTE** *If the switcher has fewer inputs or outputs than input or output buttons, only the buttons for which the switcher has an input or output perform the function of selecting and identifying that input or output.*

- ① **Input buttons** — The input buttons have two primary functions (•) and five secondary (□) functions:
- Select an input.
  - Identify the selected input.
  - **(Input 1 only)** With the Output 1 button, select *I/O Group* mode. See “*I/O grouping*” on page 3-21.
  - Select a preset. See “*Using presets*” on page 3-28.
  - **(CrossPoint 450 Plus switchers, Input 1 through 10 only)** Display the RGB delay. See “*Setting RGB delay (CrossPoint 450 Plus Switchers)*” on page 3-26.
  - **(Audio models)** Display the output volume level. See “*Viewing and adjusting the output volume (audio models)*” on page 3-41.
  - **(Input 1 and Input 2 only)** Toggle background illumination of the buttons off and on. See “*Background illumination*” on page 3-50.

- 
- ② **Output buttons** — The output buttons have two primary functions (•) and four secondary (□) functions:
- Select output(s).
  - Identify the selected output(s).
  - **(Output 1 only)** With the Input 1 button, select *I/O Group* mode. See “I/O grouping” on page 3-21.
  - **(8 x 4, 8 x 8, 12 x 4, 12 x 8, 12 x 12, and 1616 matrix sizes only)** Select a preset. See “Using presets” on page 3-28.
  - Mute the output. See “Muting and unmuting video and/or audio outputs” on page 3-32.
  - **(Audio models)** Display the audio level of the selected input. See “Viewing and adjusting the input audio level (audio models)” on page 3-35.

## Control buttons

- ③ **Enter button** — The Enter button has three primary functions (•) and six secondary (□) functions:
- Save changes that you make on the front panel. To create a simple configuration:
    - Specify RGBHV (CrossPoint 450 Plus switchers) or video (MAV Plus switchers), audio, or both (see I/O selection buttons [⑦] and [⑧])
    - Press the desired input button (①)
    - Press the desired output button(s) (②)
    - Press the Enter button.
  - Indicate that a potential tie has been created but not saved.
  - Indicate that a global preset has been selected to be saved or recalled but that the preset action has not been accomplished.
  - In the *I/O Group* mode, select group 1. See “I/O grouping” on page 3-21.
  - In the *I/O Group* mode, indicate that group 1 is selected. See “I/O grouping” on page 3-21.
  - With the Preset, View, and Esc buttons, select *Serial Port Configuration* mode. See “Selecting the rear panel Remote port protocol and baud rate” on page 3-51.
  - Select 9600 baud for the rear panel Remote port in *Serial Port Configuration* mode. See “Selecting the rear panel Remote port protocol and baud rate” on page 3-51.
  - Indicate that the rear panel Remote port is set to 9600 baud in *Serial Port Configuration* mode. See “Selecting the rear panel Remote port protocol and baud rate” on page 3-51.
  - With the RGBHV/Video and Audio buttons, select front panel security lockout mode 2 or toggle between mode 0 (unlocked) and mode 2. See “Setting the front panel locks (*Executive modes*)” on page 3-48.

## Operation, cont'd

---

- ④ **Preset button** — The Preset button has two primary functions (•) and five secondary (□) functions:
- Activates *Save Preset* mode to save a configuration as a preset and *Recall Preset* mode to activate a previously-defined preset.
  - Blinks when *Save Preset* mode is active and lights steadily when *Recall Preset* mode is active.
  - In the *I/O Group* mode, select group 2. See “I/O grouping” on page 3-21.
  - In the *I/O Group* mode, indicate that group 2 is selected. See “I/O grouping” on page 3-21.
  - With the Enter, View, and Esc buttons, select *Serial Port Configuration* mode. See “Selecting the rear panel Remote port protocol and baud rate” on page 3-51.
  - Select 19200 baud for the rear panel Remote port in *Serial Port Configuration* mode. See “Selecting the rear panel Remote port protocol and baud rate” on page 3-51.
  - Indicate that the rear panel Remote port is set to 19200 baud in *Serial Port Configuration* mode. See “Selecting the rear panel Remote port protocol and baud rate” on page 3-51.
- ⑤ **View (▼) button** — The View (▼) button has two primary functions (•) and eight secondary (□) functions:
- Select *View-Only* mode that displays the current configuration.
    - NOTE** *View-only mode also provides a way to mute and unmute the outputs. See “Muting and unmuting video and/or audio outputs” on page 3-32.*
  - Indicate that *View-Only* mode is active.
  - In the *I/O Group* mode, select group 3. See “I/O grouping” on page 3-21.
  - In the *I/O Group* mode, indicate that group 3 is selected. See “I/O grouping” on page 3-21.
  - **(CrossPoint 450 Plus switchers)** Decrease the RGB delay of switches to the selected output. See “Setting RGB delay (CrossPoint 450 Plus Switchers)” on page 3-26.
  - **(Audio models)** Decrease the audio level of the selected input. See “Viewing and adjusting the input audio level (audio models)” on page 3-35.
  - **(Audio models)** Decrease the volume of the selected output. See “Viewing and adjusting the output volume (audio models)” on page 3-41.
  - With the Enter, Preset, and Esc buttons, select *Serial Port Configuration* mode. See “Selecting the rear panel Remote port protocol and baud rate” on page 3-51.
  - Select 38400 baud for the rear panel Remote port in *Serial Port Configuration* mode. See “Selecting the rear panel Remote port protocol and baud rate” on page 3-51.
  - Indicate that the rear panel Remote port is set to 38400 baud in *Serial Port Configuration* mode. See “Selecting the rear panel Remote port protocol and baud rate” on page 3-51.

- 
- ⑥ **Esc (▲) button** — The Esc (▲) button has two primary functions (•) and eight secondary (□) functions:

- Cancel operations or selections in progress and reset the front panel button indicators.

**NOTE** *The Esc (▲) button does **not** reset the current configuration, the RGBHV (CrossPoint 450 Plus switchers) or Video (MAV Plus switchers) button and Audio selection button, any presets, or any audio gain or attenuation or volume settings.*

- Flashes once to indicate that the escape function has been activated.
- In the *I/O Group* mode, select group 4. See “I/O grouping” on page 3-21.
- In the *I/O Group* mode, indicate that group 4 is selected. See “I/O grouping” on page 3-21.
- **(CrossPoint 450 Plus switchers)** Increase the RGB delay of switches to the selected output. See “Setting RGB delay (CrossPoint 450 Plus Switchers)” on page 3-26.
- **(Audio models)** Increase the audio level of the selected input. See “Viewing and adjusting the input audio level (audio models)” on page 3-35.
- **(Audio models)** Increase the volume of the selected output. See “Viewing and adjusting the output volume (audio models)” on page 3-41.
- With the Enter, Preset, and View buttons, select *Serial Port Configuration* mode. See “Selecting the rear panel Remote port protocol and baud rate” on page 3-51.
- Select 115200 baud for the rear panel Remote port in *Serial Port Configuration* mode. See “Selecting the rear panel Remote port protocol and baud rate” on page 3-51.
- Indicate that the rear panel Remote port is set to 115200 baud in *Serial Port Configuration* mode. See “Selecting the rear panel Remote port protocol and baud rate” on page 3-51.

### I/O controls

You must specify video, audio, or both when you are creating or viewing a configuration. This is done with the RGBHV button (CrossPoint 450 Plus switchers) or Video button (MAV Plus switchers) (7) and Audio (8) buttons.

**NOTE** Throughout this chapter, the terms “RGBHV button” and “Video button” can be used interchangeably.

- 7 **RGBHV (CrossPoint 450 Plus) button or Video (MAV Plus) button** — The RGBHV (CrossPoint 450 Plus switchers) or Video (MAV Plus switchers) button has two primary functions (•) and five secondary (□) functions:
- Selects and deselects video for a configuration that is being created or viewed.
  - Lights green to indicate that video is available for configuring or for viewing.
  - With the Enter and Audio buttons, select among the front panel lock modes. See “Setting the front panel locks (*Executive modes*)” on page 3-48.
  - With the Audio button, commands the front panel system reset. See “Performing a system reset from the front panel” on page 3-50.
  - **(CrossPoint 450 Plus switchers)** Selects the *RGB delay* mode, in which you can set the RGB delay. See “Setting RGB delay (CrossPoint 450 Plus Switchers only)” on page 3-26.
  - Select the RS-232 protocol for the rear panel Remote port in *Serial Port Configuration* mode. See “Selecting the rear panel Remote port protocol and baud rate” on page 3-51.
  - Indicate that the rear panel Remote port is set to the RS-232 protocol in *Serial Port Configuration* mode. See “Selecting the rear panel Remote port protocol and baud rate” on page 3-51.
- 8 **Audio button** — The Audio button has two primary functions (•) and three secondary (□) functions
- **(Audio models only)** Selects and deselects audio for a configuration that is being created or viewed.
  - **(Audio models only)** Lights to indicate that audio is available for configuration or viewing.
  - **(Audio models only)** Selects the *Audio* mode, in which you can adjust the input audio level and the output audio volume. See “Viewing and adjusting the input audio level (audio models)” on page 3-35 and “Viewing and adjusting the output volume (audio models)” on page 3-41.
  - With the Enter and RGBHV/Video buttons, select among the front panel lock modes. See “Setting the front panel locks (*Executive modes*)” on page 3-48.
  - With the RGBHV/Video button, commands the front panel system reset. See “Performing a system reset from the front panel” on page 3-50.
  - Select the RS-422 protocol for the rear panel Remote port in *Serial Port Configuration* mode. See “Selecting the rear panel Remote port protocol and baud rate” on page 3-51.
  - Indicate that the rear panel Remote port is set to the RS-422 protocol in *Serial Port Configuration* mode. See “Selecting the rear panel Remote port protocol and baud rate” on page 3-51.

---

## Power indicators (2412 and larger models only)

### 9 Primary and Redundant Power Supply LEDs —

**Green** — Indicates that the associated power supply is operating within normal tolerances.

**Red** — Indicates that the associated power supply is operating outside the normal tolerances or has failed.

## Button icons

The numbered translucent covers on the input and output pushbuttons can be removed and replaced to insert labels behind the covers.

Input and output labels can be created easily with Extron's Button-Label Generator software, which ships with every Extron matrix switcher. Each input and output can be labeled with names, alphanumeric characters, or even color bitmaps for easy and intuitive input and output selection (figure 3-4). See chapter 5, "Matrix Software", for details on using the labeling software. See Appendix B, "Reference Information", for blank labels and a procedure for removing and replacing the translucent covers.

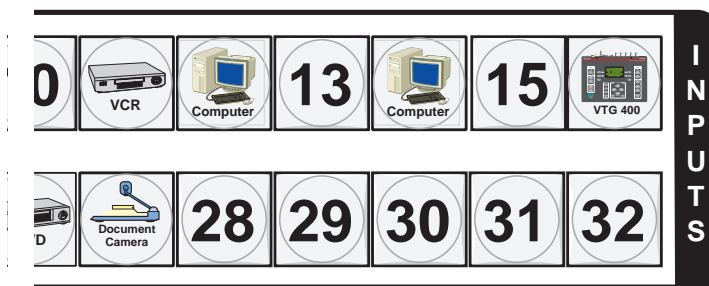


Figure 3-4 — Sample button icons

## Front Panel Operations

The following paragraphs detail the power-up process and then provide sample procedures for creating ties; changing a configuration; viewing configurations; saving and recalling a preset; muting and unmuting outputs, viewing and adjusting the audio level; viewing and adjusting the output volume; locking out the front panel; performing one of several resets; toggling background illumination on and off; and reading and setting the rear panel Remote port settings.

### Front panel security lockouts

In the procedural descriptions that follow, it is assumed that the switcher is in *Lock mode 0* (fully unlocked). The following two *Lock modes* are also available:

- **Lock mode 1** — All changes are locked from the front panel (except for setting *Lock mode 2*). Some functions can be viewed.
- **Lock mode 2** — Advanced features are locked and can be viewed only. Basic functions are unlocked.

See "Setting the front panel locks (*Executive modes*)" on page 3-48 for a detailed list of basic and advanced functions and the procedure to set the various front panel locks.



## Operation, cont'd

---

### Power

Apply power by connecting the power cord to an AC source. The switcher performs a self-test that flashes the front panel button indicators green, red, and amber and then turns them off. (The order in which the colors are displayed depends on the model.) An error-free power up self-test sequence leaves all I/O and control buttons either unlit or showing background illumination. The lit/unlit status of the RGBHV or Video button and the Audio button is defined by the system configuration as follows:

- **Systems with audio** — RGBHV/Video and Audio both lit
- **Systems without audio** — RGBHV/Video lit and Audio unlit

The current configuration and all presets are saved in non-volatile memory. When power is applied, the most recent configuration is retrieved. The previous presets remain intact.

If an error occurs during the self-test, the switcher locks up and does not operate. If your switcher locks up on power-up, call the Extron S<sup>3</sup> Sales & Technical Support Hotline.

### Creating a configuration

The current configuration can be changed using the front panel buttons. Change the current configuration as follows:

1. Press the Esc button to clear any input button indicators, output button indicators, or control button indicators that may be lit.
2. Select to configure video, audio, or both by pressing the RGBHV (CrossPoint 450 Plus switchers) or Video (MAV Plus switchers) button and/or Audio button.
3. Select the desired input and output(s) by pressing the input and output buttons.

Input buttons light amber (matrix sizes up to 1616) or green (matrix sizes above 1616). Output buttons light or blink **amber** to indicate video and audio ties, **green** to indicate video only ties, and **red** to indicate audio only ties.

To indicate **potential ties**, output buttons **blink** the appropriate color when an input is selected.

To indicate **current ties**, output buttons **light steadily** the appropriate color when an input is selected.

To clear unwanted outputs, press and release the associated lit output buttons. To indicate **potential unties**, output buttons **blink** the appropriate color when an output is deselected but not untied from the input.

4. Press and release the Enter button to accept the tie.
5. Repeat steps 1 through 4 to create additional ties until the desired configuration is complete.

- NOTE**
- *Only one video input and one audio input can be tied to an output.*
  - *If a tie is made between an input and an output, and the selected output was previously tied to another input, the older tie is broken in favor of the newer tie.*
  - *If an input with no tie is selected, only that input's button lights.*

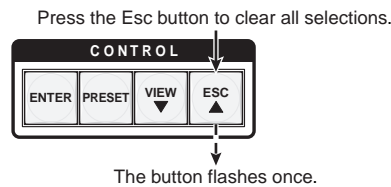
- When the RGBHV (CrossPoint 450 Plus switchers) or Video (MAV Plus switchers) button and Audio button are lit, if an input with an audio tie but no video tie is selected, the input's button lights amber (matrix sizes up to 1616) or green (matrix sizes 3232 and above) and the output button lights the appropriate color (amber, green, or red).
- As each input and output is selected, the associated output button blinks the appropriate color to indicate a tentative tie. Buttons for output(s) that were already tied to the input light the appropriate color steadily. Outputs that are already tied can be left on, along with new blinking selections, or toggled off by pressing the associated output button.
- If you press the input button for an I/O grouped input and then try to select an output in a different group, the associated output button cannot be selected. The associated input button remains lit.

### Example 1: Creating a set of video and audio ties

In the following example, input 5 is tied to outputs 3, 4, and 8. The steps show the front panel indications that result from your action.

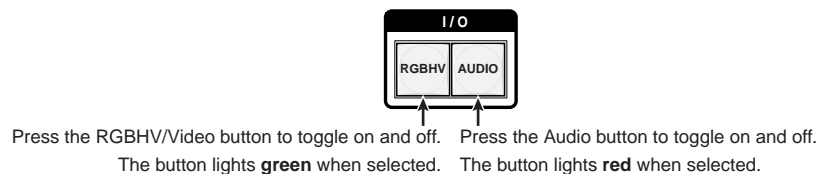
**NOTE** This example assumes that there are no ties in the current configuration.

1. Press and release the Esc button (figure 3-5).



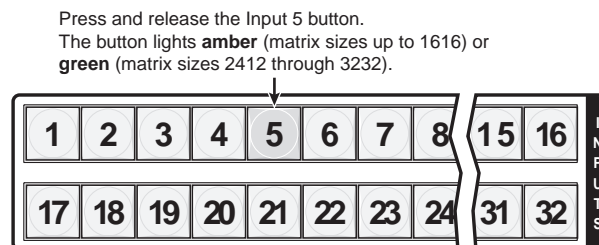
**Figure 3-5 — Clear all selections**

2. To select video and audio for the tie, if necessary, press and release the RGBHV (CrossPoint 450 Plus switchers) or Video (MAV Plus switchers) button and the Audio button until the buttons light (figure 3-6).



**Figure 3-6 — Select RGBHV or video and audio**

3. Press and release the input 5 button (figure 3-7).



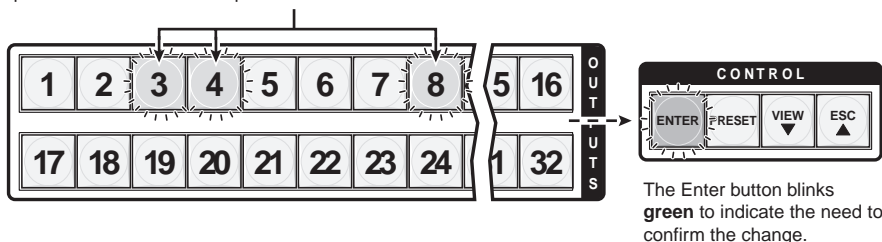
**Figure 3-7 — Select an input**

## Operation, cont'd

- Press and release the output 3, output 4, and output 8 buttons (figure 3-8).

**NOTE** *The entire set of ties can be canceled at this point by pressing and releasing the Esc button. The Esc button flashes green (matrix sizes up to 1616) or red (matrix sizes 3232 and above) once.*

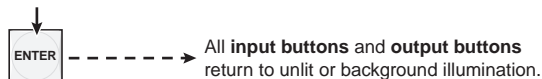
Press and release the Output 3, Output 4, and Output 8 buttons.  
The buttons blink **amber** to indicate that the selected RGBHV or video and audio input will be tied to these outputs.



**Figure 3-8 — Select the outputs**

- Press and release the Enter button (figure 3-9).

Press the Enter button to confirm the configuration change.

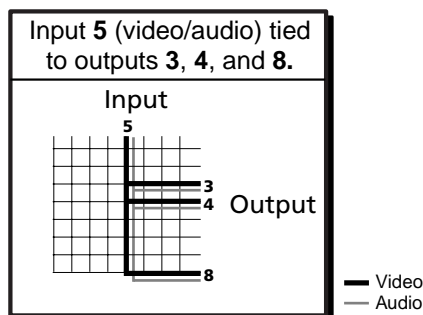


The Enter button returns to unlit or background illumination.

**Figure 3-9 — Press the Enter button**

The current configuration (figure 3-10) is now:

- Input 5 video and audio tied to output 3, output 4, and output 8



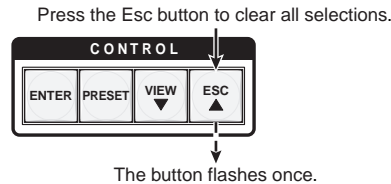
**Figure 3-10 — Example 1, final configuration**

## Example 2: Adding a tie to a set of video and audio ties

In the following example, a new video tie is added to the current configuration. The steps show the front panel indications that result from your action.

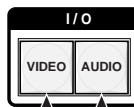
**NOTE** This example assumes that you have performed example 1.

1. Press and release the Esc button (figure 3-11).



**Figure 3-11 — Clear all selections**

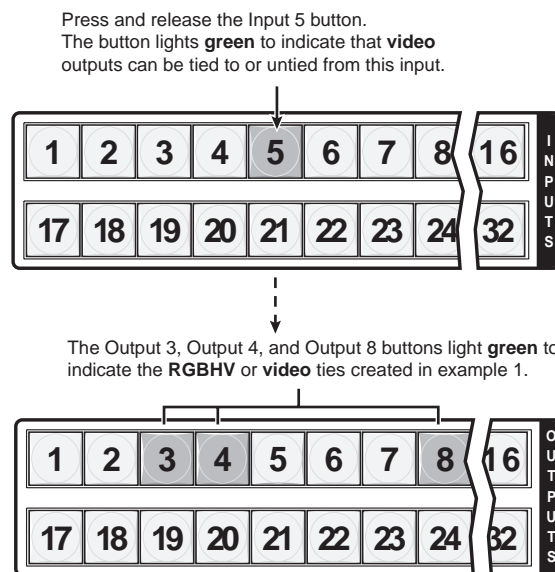
2. To select video only for the tie, if necessary, press and release the RGBHV (CrossPoint 450 Plus switchers) or Video (MAV Plus switchers) button and the Audio button (figure 3-12).



Press the RGBHV/Video button to toggle on and off. Press the Audio button to toggle on and off. The button lights **green** when selected. The button is **unlit** or **background illuminated** when deselected.

**Figure 3-12 — Select RGBHV or video only**

3. Press and release the input 5 button (figure 3-13).

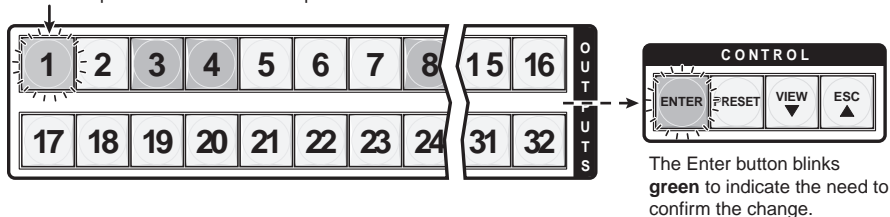


**Figure 3-13 — Select an input**

## Operation, cont'd

4. Press and release the output 1 button (figure 3-14).

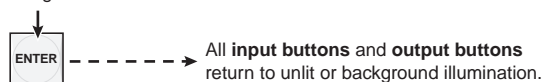
Press and release the Output 1 button.  
The button blinks **green** to indicate that only the selected **RGBHV** or **video** input will be tied to this output.



**Figure 3-14 — Select the output**

5. Press and release the Enter button (figure 3-15).

Press the Enter button to confirm the configuration change.

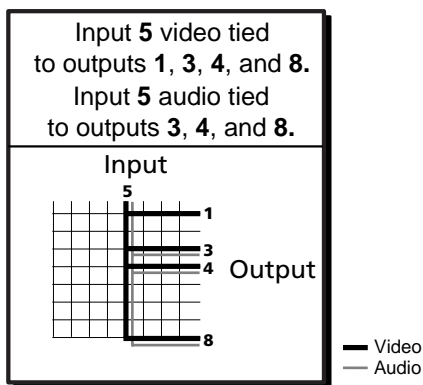


The Enter button returns to unlit or background illumination.

**Figure 3-15 — Press the Enter button**

The current configuration (figure 3-16) is now:

- Input 5 video tied to outputs 1, 3, 4, and 8
- Input 5 audio tied to outputs 3, 4, and 8



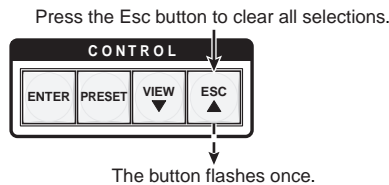
**Figure 3-16 — Example 2, final configuration**

### Example 3: Removing a tie from a set of video and audio ties

In the following example, an existing audio tie is removed from the current configuration. The steps show the front panel indications that result from your action.

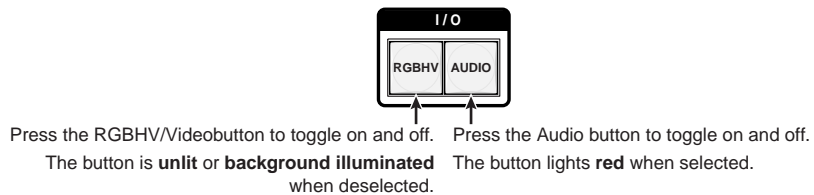
**NOTE** This example assumes that you have performed example 1 and example 2.

1. Press and release the Esc button (figure 3-17).



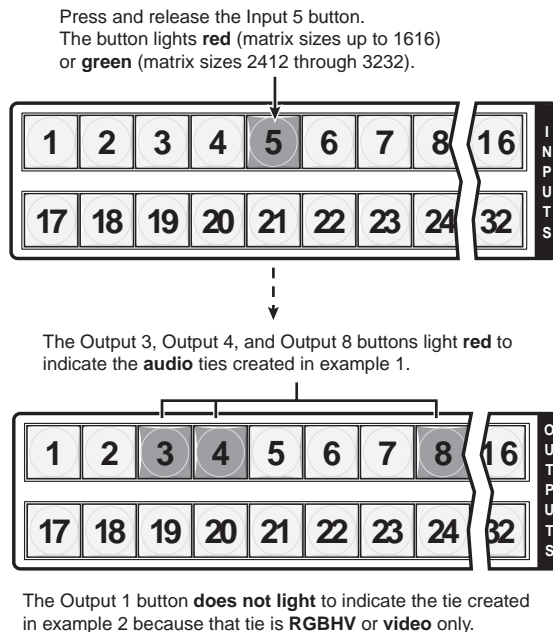
**Figure 3-17 — Clear all selections**

2. To select audio only for the tie, if necessary, press and release the RGBHV (CrossPoint 450 Plus switchers) or Video (MAV Plus switchers) button and the Audio button (figure 3-18).



**Figure 3-18 — Select audio only**

3. Press and release the input 5 button (figure 3-19).

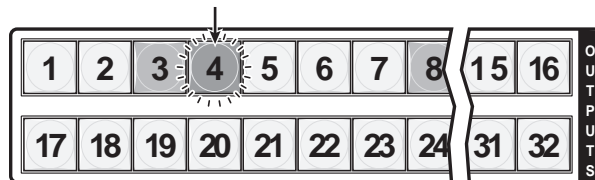


**Figure 3-19 — Select an input**

## Operation, cont'd

- Press and release the output 4 button (figure 3-20).

Press and release the Output 4 button.  
The button blinks **red** to indicate the pending change:  
**audio** input will be untied.



The Enter button blinks **green** to indicate the need to confirm the change.

**Figure 3-20 — Deselect the output**

- Press and release the Enter button (figure 3-21).

Press the Enter button to confirm the configuration change.



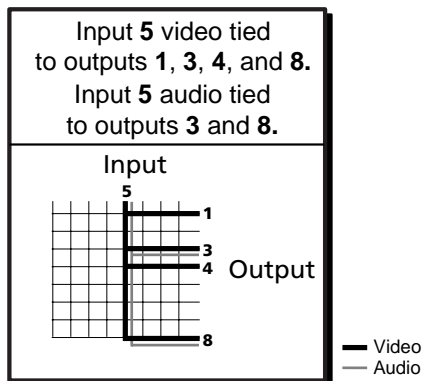
All **input buttons** and **output buttons** return to unlit or background illumination.

The Enter button returns to unlit or background illumination.

**Figure 3-21 — Press the Enter button**

The current configuration (figure 3-22) is now:

- Video** —  
(Video only models) — Input 5 tied to output 1, output 3, output 4, and output 8  
(Video and audio models) — Input 5 video tied to output 1, output 3, output 4, and output 8
- Audio** — (audio models) Input 5 audio tied to output 3 and output 8



**Figure 3-22 — Example 3, final configuration, audio switcher**

---

## Viewing a configuration

The current configuration can be viewed using the front panel buttons. The *View-Only* mode prevents inadvertent changes to the current configuration. *View-Only* mode also provides a way to mute video and audio outputs (see “Muting and unmuting video and/or audio outputs” on page 3-32).

View the current configuration as follows:

1. Press the Esc button to clear any input button indications, output button indications, or control button indications that may be on.
2. Press and release the View button. All of the buttons for outputs that are **not** tied light:
  - **Amber:** No tied video or audio input
  - **Green:** No tied video input
  - **Red:** No tied audio input
3. Select video, audio, or both to view by pressing the RGBHV (CrossPoint 450 Plus switchers) or Video (MAV Plus switchers) button and/or the Audio button.
4. Select the desired input or output(s) whose ties you wish to view by pressing the input and output buttons.

- NOTE**
- *When you enter View-Only mode, the output buttons light for all outputs without ties. Likewise, when an output button for which there are no ties is pushed, the output buttons turn on for all outputs without ties.*
  - *To see all ties of the current configuration, press and release each input and output button, one at a time, with the RGBHV (CrossPoint 450 Plus switchers) or Video (MAV Plus switchers) button and the Audio button lit.*
  - *In View-Only mode, you can view video and audio, video-only, or audio-only ties. Pressing and releasing the RGBHV (CrossPoint 450 Plus switchers) or Video (MAV Plus switchers) button and the Audio button toggles each on and off.*
  - *When you view video and audio ties, the RGBHV (CrossPoint 450 Plus switchers) or Video (MAV Plus switchers) button is lit green and the Audio button is lit red. After you select an input or output, the output buttons light different colors to show where video and audio ties are not the same (audio is broken away). Amber = video and audio, green = video only, and red = audio only.*
  - *After 30 seconds of front panel inactivity, View-Only mode automatically deselects.*



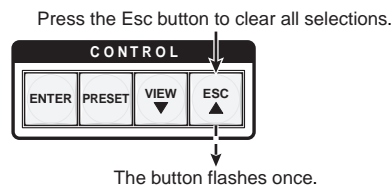
## Operation, cont'd

### Example 4: Viewing video and audio, audio only, and video only ties

In the following example, we view the video and audio, audio-only, and video-only ties in the current configuration. The steps show the front panel indications that result from your action.

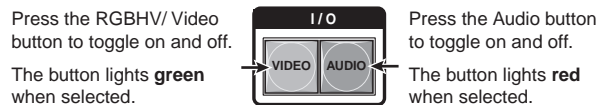
**NOTE** This example assumes that you have performed example 1, example 2, and example 3.

1. Press and release the Esc button (figure 3-23).

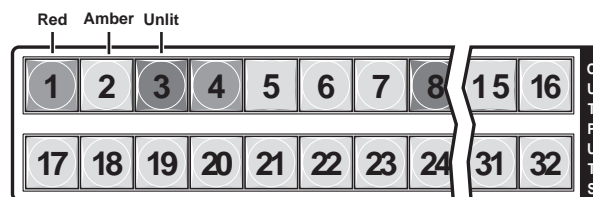


**Figure 3-23 — Clear all selections**

2. Press and release the View button to enter *View-Only* mode. The View button lights red.
3. To select both video and audio for viewing, if necessary, press and release the RGBHV (CrossPoint 450 Plus switchers) or Video (MAV Plus switchers) button and the Audio button (figure 3-24).



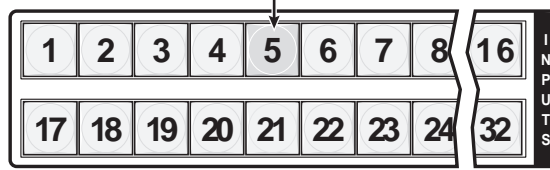
Until you select an input, the buttons for all untied outputs light **amber** if **no inputs** are tied, **green** if **no video inputs** are tied (only audio is tied), or **red** if **no audio inputs** are tied (only video is tied).



**Figure 3-24 — Select RGBHV or video and audio**

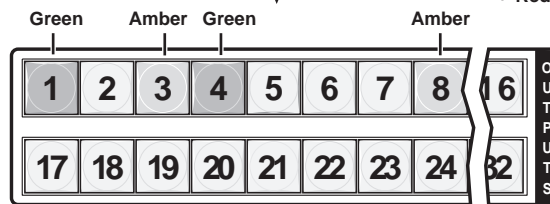
4. Press and release the input 5 button (figure 3-25).

Press and release the Input 5 button.  
The button lights **amber** (matrix sizes up to 1616) or **green** (matrix sizes 2412 through 3232).



The output buttons for outputs that **are** tied to Input 5 light the appropriate color:

- **Amber** for **audio** and **RGBHV** or **video** ties (audio follow)
- **Green** for **RGBHV** or **video** ties (audio breakaway)
- **Red** for **audio** ties (audio breakaway)



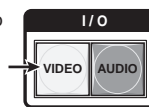
The output buttons for outputs that are **not** tied to Input 5 are either unlit or background illuminated.

**Figure 3-25 — Select an input**

**NOTE** A set of ties can also be viewed by selecting a tied output. To demonstrate this, note the number of a lit output button, and then press and release the output button for an untied (unlit or background illumination) output. Observe that all of the untied outputs light. Then press the output button that you noted previously and observe that the selected output button, the tied input button (input 5), and the output buttons light for all of the outputs that are tied to the input.

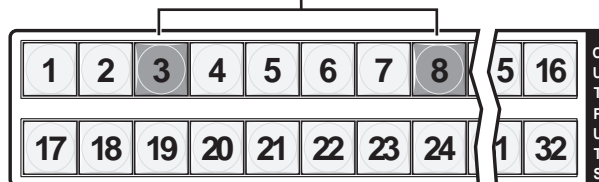
5. Press and release the RGBHV (CrossPoint 450 Plus switchers) or Video (MAV Plus switchers) button to deselect RGBHV or video (figure 3-26).

Press the RGBHV/Video button to deselect it.  
The button is unlit or background illuminated when deselected.



The Audio button remains lit **red** to indicate that only **audio** is selected.

The output buttons for outputs that **are** tied to Input 5 light **red** to indicate **audio** ties (audio breakaway).

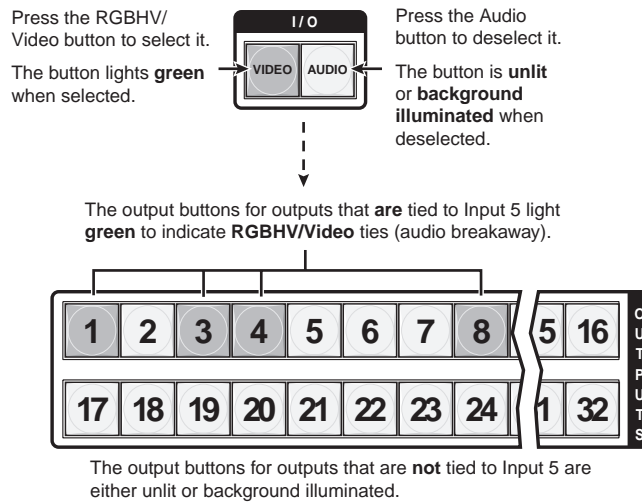


The output buttons for outputs that are **not** tied to Input 5 are either unlit or background illuminated.

**Figure 3-26 — Deselect RGBHV or video to view audio ties only**

## Operation, cont'd

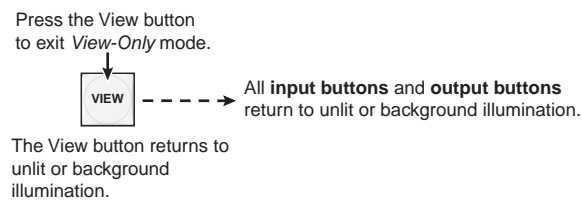
6. Press and release the RGBHV (CrossPoint 450 Plus switchers) or Video (MAV Plus switchers) button and the Audio button to toggle the RGBHV or Video button on green and the Audio button either unlit or providing background illumination (figure 3-27).



**Figure 3-27 — Deselect audio and select RGBHV or video to view RGBHV or video only**

If video ties are established for input 5, the output buttons for all video outputs tied to input 5 light green. If no ties are established for input 5, all output buttons return to either unlit or to background illumination.

7. Press and release the View button to exit *View-Only* mode (figure 3-28).



**Figure 3-28 — Press the View button to exit View-Only mode**

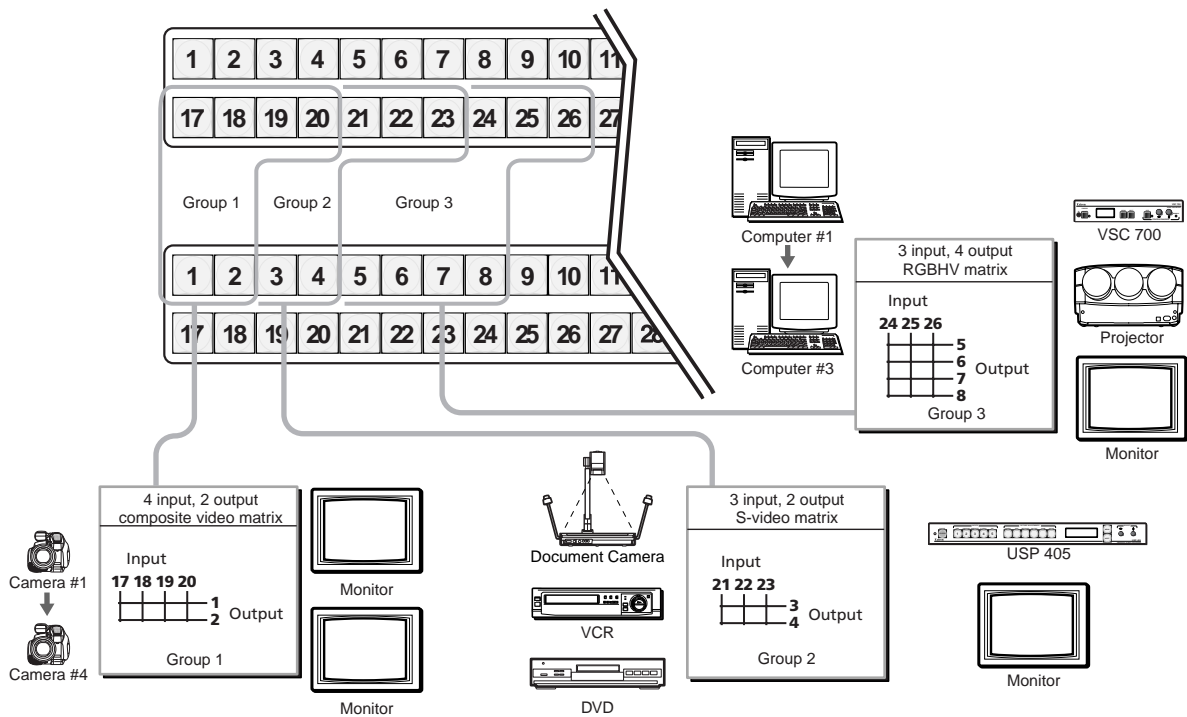
## I/O grouping

I/O grouping is a matrix switcher feature that allows you to subdivide the front panel control of the matrix into four smaller functional sub-switchers and limit tie creation **from the front panel only**. Inputs and outputs can be assigned to one of four groups or not assigned to any group.

Inputs and outputs that are assigned to a group can only be tied to other outputs and inputs within the same group when you are creating ties on the front panel. For example, a front panel operator cannot tie an input that is assigned to group 1 to an output that is assigned to group 2. Ungrouped inputs and outputs can be switched to outputs and inputs in any group. Ties between groups (an input in group 1 tied to an output in group 2) **can** be created under serial port or Ethernet control.

Suggested applications for the I/O grouping feature include:

- Segregating specific video formats to prevent an input in one video format from being inadvertently applied to an output device that supports another video format (figure 3-29).
- Segregating input and output devices that are in separate rooms.
- Isolating video from being displayed on specific output devices for operational security reasons.



**Figure 3-29 — I/O grouping of incompatible video formats**

## Operation, cont'd

---

The I/O groups can be set up on the front panel or by using serial port and Ethernet ports and either the SIS or the Windows control program (see chapter 4, “Programmer’s Guide”, and chapter 5, “Matrix Software”). Create I/O groups on the front panel as follows:

**NOTE** *I/O groups are protected when front panel lock mode 2 is selected. You can view the groups in lock mode 2, but not change them from the front panel.*

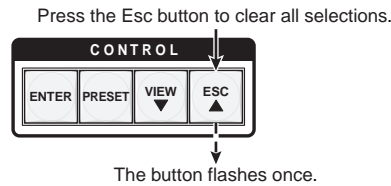
1. Press the Esc button to clear any input buttons, output buttons, or control buttons that may be lit.
2. To enter *I/O Group* mode, press and **hold** the Input 1 and Output 1 buttons until the input and output buttons light to display the ungrouped inputs and outputs.
3. Press and release one of the Control buttons to select a group:
  - Press the Enter button to select group 1.
  - Press the Preset button to select group 2.
  - Press the View button to select group 3.
  - Press the Esc button to select group 4.
4. Select the desired input(s) and output(s) to assign to the group by pressing the input and output buttons.
5. Press and release the RGBHV/Video and Audio button to exit the *I/O Group* mode, or allow the mode to time out after approximately 30 seconds.

- NOTE**
- *Ties between groups (an input in group 1 tied to an output in group 2) can be created under serial port or Ethernet control.*
  - *Presets can be created under serial port or Ethernet control that tie inputs and outputs across group boundaries. These presets **are** selectable from the front panel.*
  - *An input or output can be assigned to only one group. If you assign an input or output to a group and that input or output is already assigned to a different group, the older grouping is discarded in favor of the new grouping.*
  - *Audio **can** be broken away from the video for a given input or output (assigned to different groups) by isolating only video or only audio using the front panel RGBHV (CrossPoint 450 Plus)/Video (MAV Plus) and/or Audio buttons after you select I/O Group mode (between steps 2 and 3).*  
*Audio breakaway across different groups **can be** confusing when operating the front panel; **is not displayed** by the Matrix Switchers Control Program, HTML pages, or SIS commands; and is **not** recommended.*
  - *For I/O groups to have any function, at least two groups must be created.*

### Example 5: Grouping inputs and outputs

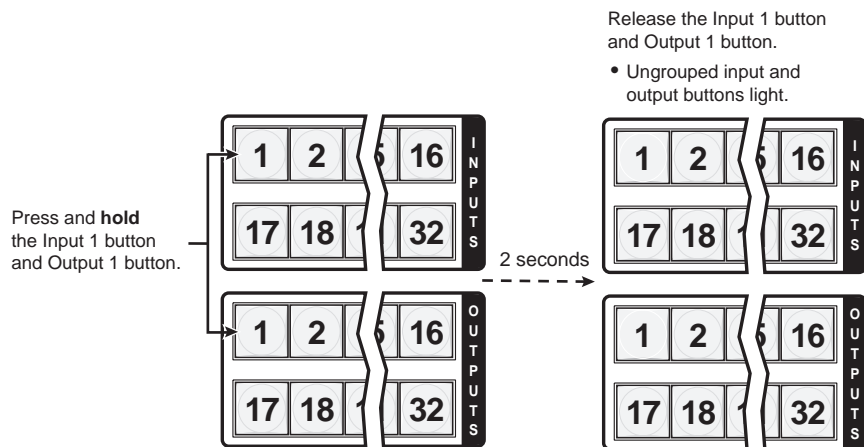
In the following example, several switcher inputs and outputs are assigned to groups. The steps show the front panel indications that result from your action.

1. Press and release the Esc button (figure 3-30).



**Figure 3-30 — Clear all selections**

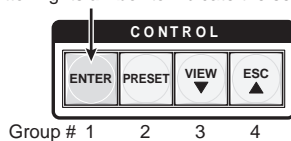
2. To enter I/O Group mode, press and hold the Input 1 and Output 1 buttons (figure 3-31).



**Figure 3-31 — Select I/O Group mode**

3. Press and release the Enter button to select group 1 (figure 3-32).

Press and release the Enter button to select group 1.  
The button lights **amber** to indicate the selection.



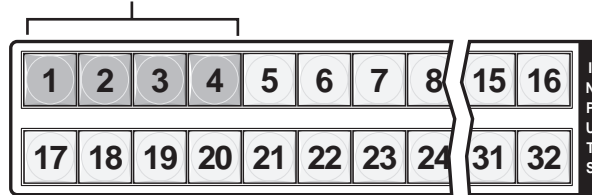
**Figure 3-32 — Select an I/O group**

## Operation, cont'd

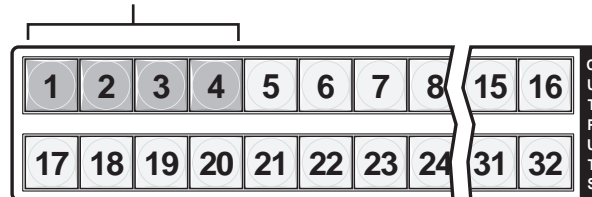
- NOTE** I/O groups are protected when front panel lock mode 2 is selected. You can view the groups in lock mode 2, but not change them from the front panel.
- If front panel lock mode 2 is selected and you try to perform steps 4 through 6, the actions are ignored and the Enter, RGBHV/Video, and Audio buttons flash.

4. Press and release the input 1 through 4 and output 1 through 4 buttons (figure 3-33).

Press and release the Input 1 through Input 4 buttons.  
The selected buttons light **green**.



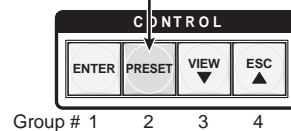
Press and release the Output 1 through Output 4 buttons.  
The selected buttons light **green**.



**Figure 3-33 — Assign inputs and outputs**

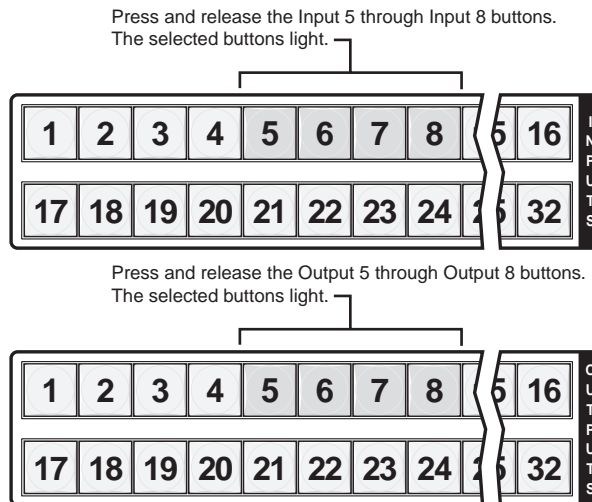
5. Press and release the Preset button to select group 2 (figure 3-34).

Press and release the Preset button to select group 2.  
The button lights **amber** to indicate the selection.



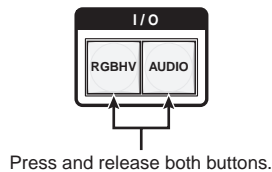
**Figure 3-34 — Select an I/O group**

- Press and release the input 5 through 8 and output 5 through 8 buttons (figure 3-35).



**Figure 3-35 — Assign inputs and outputs**

- Press and release the RGBHV (CrossPoint 450 Plus switchers) or Video (MAV Plus switchers) button and the Audio button until the buttons light (figure 3-36). The switcher exits *I/O Group* mode.



**Figure 3-36 — Exit I/O Group mode**

**NOTE** As an alternative, do nothing for approximately 30 seconds. The front panel times out and the switcher exits *I/O Group* mode.

- Group 1 consists of inputs 1 through 4 and outputs 1 through 4.
- Group 2 consists of inputs 5 through 8 and outputs 5 through 8.



### Setting RGB delay (CrossPoint 450 Plus switchers only)

The CrossPoint 450 Plus switchers can briefly blank the RGB (video) output while it switches to the new input's sync source, and then switches the RGB signals. This allows a brief delay for the display to adjust to the selected input's sync timing before displaying the new picture, which will appear without glitches. RGB delay, also known as Triple-Action Switching or video mute switching, is user selectable from 0 to 5 seconds, in half-second increments.

The RGB delay interval can be set on the front panel or by using either serial port or the Ethernet port and either the SIS, Windows control program, or HTML pages (see chapter 4, "Programmer's Guide", chapter 5, "Matrix Software", and chapter 6, "HTML operation". Specify the RGB delay interval for a specific output on the front panel as follows:

**NOTE** *RGB delay is protected when front panel lock mode 2 is selected. You can view the delay in lock mode 2, but not change it from the front panel.*

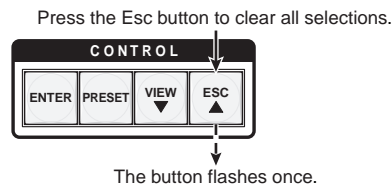
1. Press the Esc button to clear any input buttons, output buttons, or control buttons that may be lit.
2. To enter *RGB Delay* mode, press and **hold** the RGBHV button until the button begins to blink green, then release the button.
3. Press and release an output button to select an output. Each lit input button, from Input 1 through Input 10, indicates a half second of RGB delay interval for the selected output.
4. Press and release the Esc (▲) and View (▼) buttons to increase and decrease the interval.
5. Press and release the RGBHV button to exit the *RGB Delay* mode. The RGBHV button stops blinking.

- NOTE**
- *Pressing the Enter or Preset button also exits RGB Delay mode. Pressing the Preset button changes to Recall Preset mode.*
  - *The RGB interval for each output is stored in non-volatile memory. When power is removed and restored, the delay settings are retained.*
  - *Exiting RGB Delay mode by pressing the RGBHV button always returns the I/O configuration to audio only selected for configuration.*

#### Example 6: Setting the RGB delay for an output

In the following example, the RGB delay is increased for output 17. The steps show the front panel indications that result from your action.

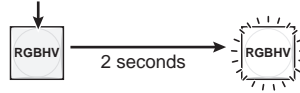
1. Press and release the Esc button (figure 3-37).



**Figure 3-37 — Clear all selections**

- Press and **hold** the RGBHV button for approximately 2 seconds (figure 3-38).

Press and hold the RGBHV button until it blinks.



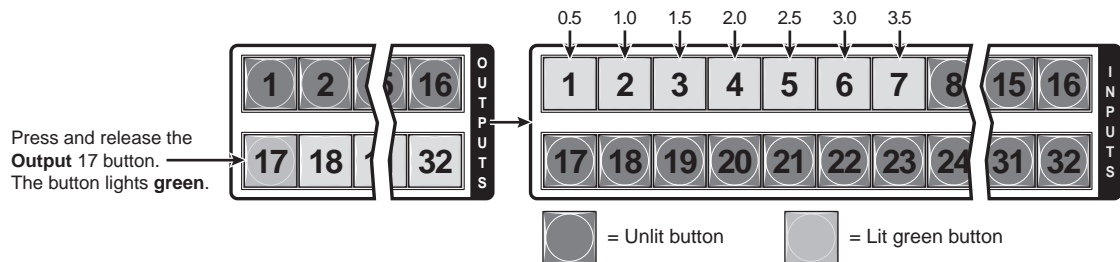
**Figure 3-38 — Select RGB Delay mode**

- Press and release the output 17 button (figure 3-39).

The input buttons 1 through 10 display the selected output's RGB delay.

Each lit input button indicates half a second of delay.

In this example, the **green** input buttons display 3.5 seconds of RGB delay.



**Figure 3-39 — Select an output**

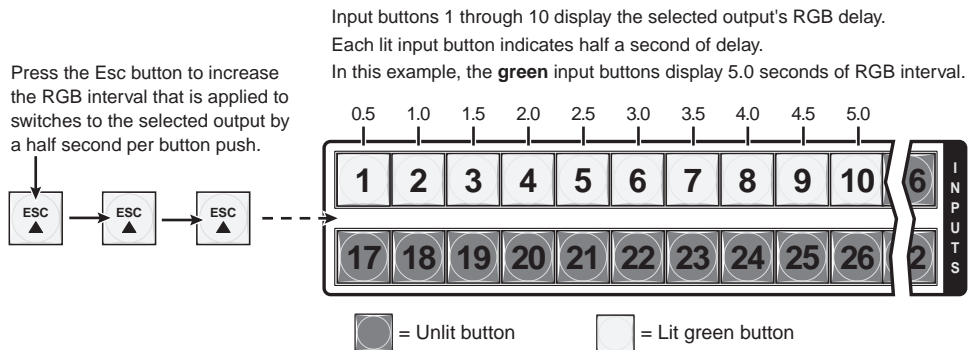
**NOTE** The RGB delay is protected when front panel lock mode 2 is selected. You can view the delay in lock mode 2, but not change it from the front panel.

If front panel lock mode 2 is selected and you try to perform steps 4, the actions are ignored and the Enter, RGBHV/Video, and Audio buttons flash.

- Press and release the Esc (▲) button once (figure 3-40) to increase the RGB delay by a half second.

Press and release the Esc (▲) button twice more to increase the RGB delay by a whole second. Note the input button indication changes that occur each time the Esc (▲) button is pressed and released.

Figure 3-40 show the result of pressing the Esc (▲) button a total of 3 times.

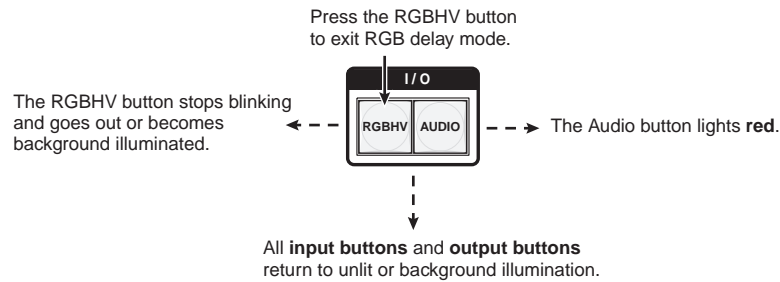


**Figure 3-40 — Adjust the RGB delay interval**

## Operation, cont'd

---

5. Press and release the RGBHV button (figure 3-41).

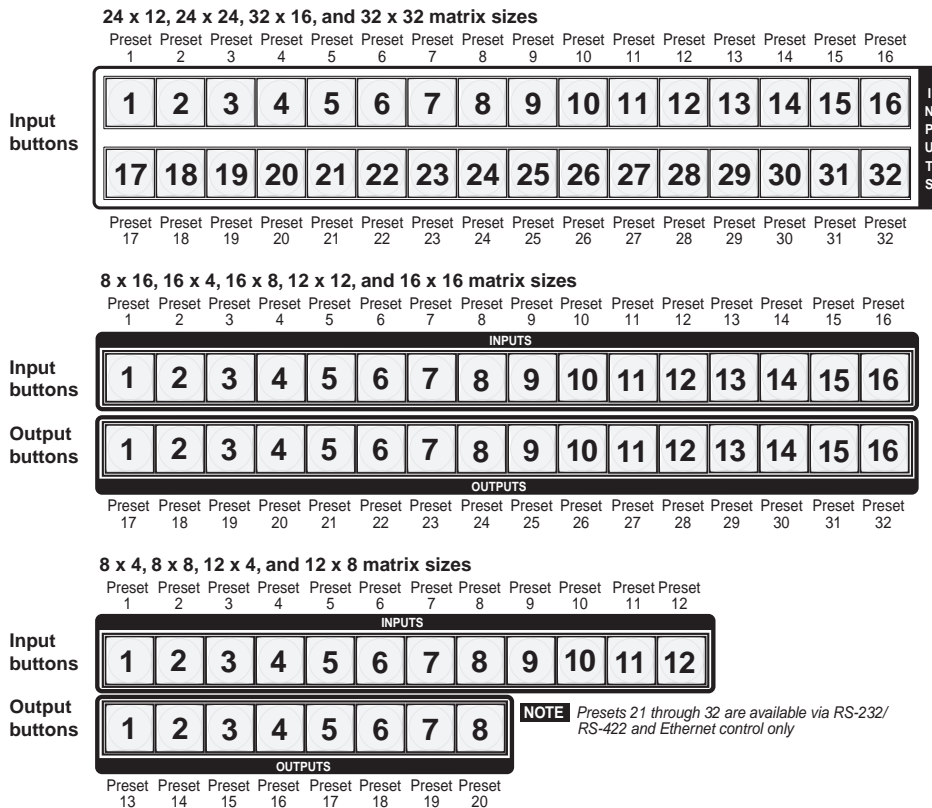


**Figure 3-41 — Deselect RGB Delay mode**

### Using presets

The current configuration (configuration 0) can be saved as a preset in any one of 32 preset memory addresses. Preset locations are assigned to the input buttons and (where necessary) output buttons. Up to 20 or 32 (depending on the number of input and output buttons) presets can be selected from the front panel to be either saved or retrieved. When a **preset** is retrieved from memory, it becomes the **current configuration**.

- NOTE**
- Only the audio and video ties are stored and recalled; audio gain settings are not saved, and they do not change when a preset is recalled.
  - Presets **cannot** be viewed from the front panel unless recalled as the current configuration. Presets **can** be viewed using Extron's Windows-based control program. See Chapter 5, "Matrix Software", for more details.
  - The current configuration and all presets are stored in non-volatile memory. When power is removed and restored, the current configuration is still active and all presets are retained.
  - When a preset is recalled, it replaces the current configuration, which is lost unless it is also stored as a preset. The recalled preset overwrites all of the current configuration ties in favor of the preset configuration ties.
  - All models have 32 presets; on models with fewer than 32 input and output buttons, preset numbers that are too high to be available from the front panel are still accessible under serial port or Ethernet control.
  - Figure 3-42 on the next page shows the presets associated with the various input and output buttons for all three front panel configurations.

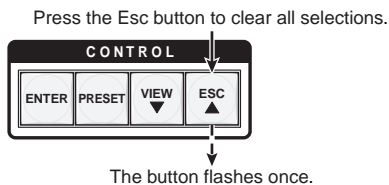


**Figure 3-42 — Preset locations by matrix sizes**

**Example 7: Saving a preset**

The following steps show an example in which the current configuration is saved as a preset. The steps show the front panel indications that result from your action.

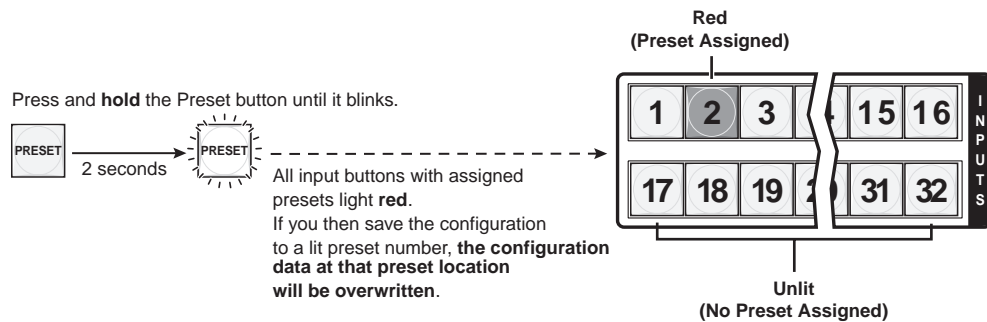
1. Press and release the Esc button (figure 3-43).



**Figure 3-43 — Clear all selections**

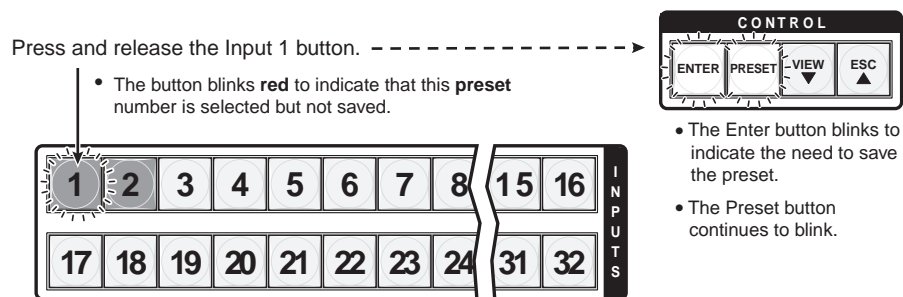
## Operation, cont'd

2. Press and **hold** the Preset button for approximately 2 seconds until it blinks (figure 3-44).



**Figure 3-44 — Enter Save Preset mode**

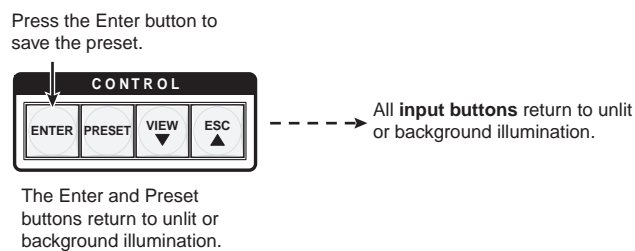
3. Press and release the input or output button for the desired preset (figure 3-45).



**Figure 3-45 — Select the preset**

**NOTE** Figure 3-42 on page 3-29 shows the presets associated with the various input and output buttons for all three front panel configurations.

4. Press and release the Enter button (figure 3-46). The current configuration is now stored in the selected memory location.

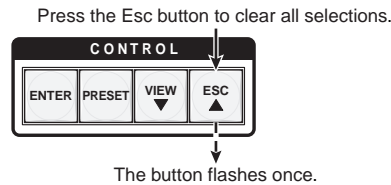


**Figure 3-46 — Press the Enter button**

### Example 8: Recalling a preset

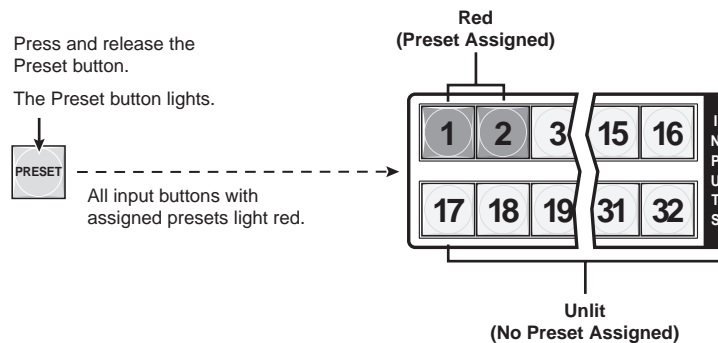
The following steps show an example in which a preset is recalled to become the current configuration. The steps show the front panel indications that result from your action.

1. Press and release the Esc button (figure 3-47).



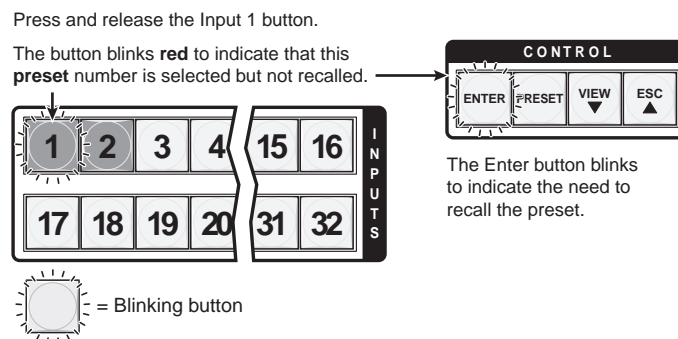
**Figure 3-47 — Clear all selections**

2. Press and release the Preset button (figure 3-48).



**Figure 3-48 — Enter Recall Preset mode**

3. Press and release the input or output button for the desired preset (figure 3-49).

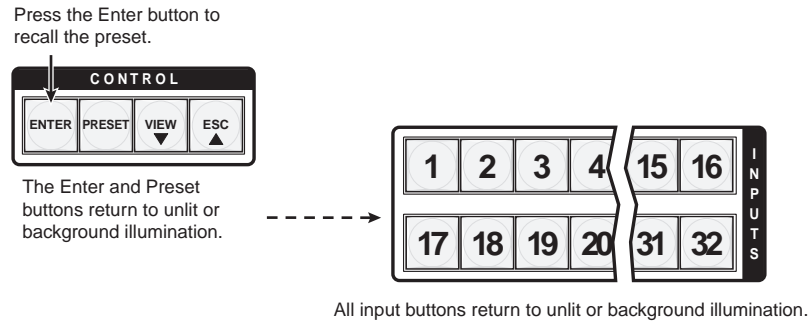


**Figure 3-49 — Select the preset**

**NOTE** Figure 3-42 on page 3-29 shows the presets associated with the various input and output buttons for all three front panel configurations.

## Operation, cont'd

4. Press and release the Enter button (figure 3-50). The configuration stored in selected memory location is now the current configuration and can be viewed in the *View-Only* mode (see example 4).



**Figure 3-50 — Press the Enter button**

### Muting and unmuting video and/or audio outputs

Individual outputs can be muted or unmuted as follows:

**NOTE** *Mutes are protected when front panel lock mode 2 is selected. You can view the status of the output (muted or unmuted) in lock mode 2, but not change it from the front panel.*

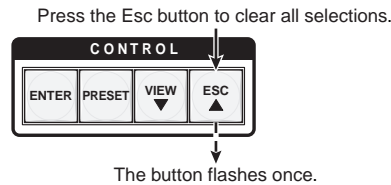
1. Press the Esc button to clear any input button indications, output button indications, or control button indications that may be on.
2. Press and release the View button.
3. Select video, audio, or both to mute or unmute by pressing the RGBHV (CrossPoint 450 Plus switchers) or Video (MAV Plus switchers) button and/or the Audio button.
4. One at a time, press and **hold** the output button(s) for the desired output(s) for approximately 2 seconds. The output LED(s) for the selected output(s) blink to indicate the mute or return to their previous state to indicate the unmute.
5. Press and release the View button to return to normal switcher operation.

- NOTE**
- *You can mute video and audio, video-only, or audio-only outputs. Pressing and releasing the RGBHV (CrossPoint 450 Plus switchers) or Video (MAV Plus switchers) button and the Audio button toggles each selection on and off.*
  - *When you enter View-Only mode, the output LEDs turn **on** for all outputs **without** ties.*
  - *On CrossPoint 450 Plus switchers, the video mute function mutes the R, G, and B planes only; the H and V planes are still active. On MAV Plus switchers, the video mute function mutes all video planes.*
  - *Mutes are saved to non-volatile memory. When power is removed and restored, the mute settings are retained.*

### Example 9: Muting and unmuting an output

The following steps show an example in which several switcher outputs are muted and unmuted. The steps show the front panel indications that result from your action.

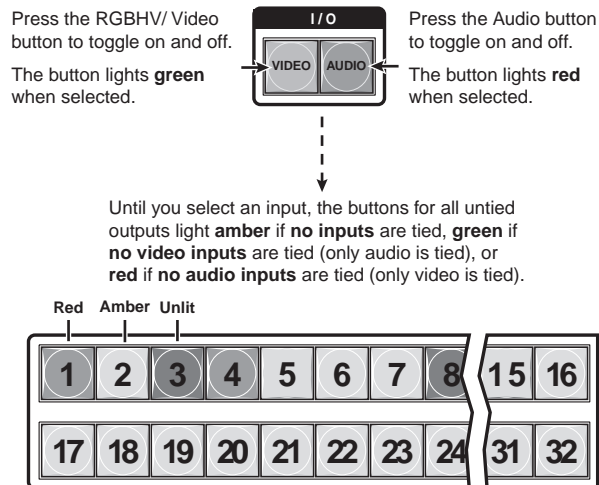
1. Press and release the Esc button (figure 3-51).



**Figure 3-51 — Clear all selections**

2. Press and release the View button to enter *View-Only* mode. The View button lights red.
3. To select both video and audio for viewing and muting, if necessary, press and release the RGBHV (CrossPoint 450 Plus switchers) or Video (MAV Plus switchers) button and the Audio button (figure 3-52).

**NOTE** This example shows the front panel indications if example 1, example 2, and example 3 have been completed.



**Figure 3-52 — Select RGBHV or video and audio**

**NOTE** Output mutes are protected when front panel lock mode 2 is selected. You can view the mutes in lock mode 2, but not change them from the front panel.

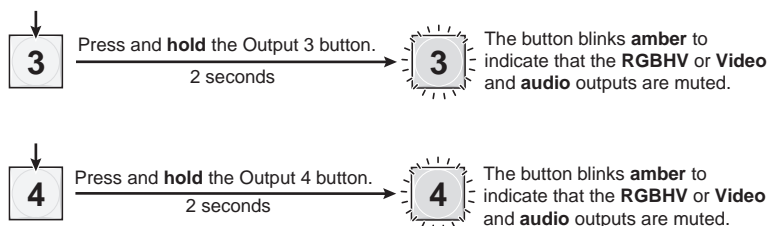
If front panel lock mode 2 is selected and you try to perform steps 4 and 5, the actions are ignored.



## Operation, cont'd

4. **One at a time**, press and **hold** the Output 3 and then the Output 4 buttons (figure 3-53) for approximately 2 seconds until the buttons begin to blink. The output 3 and output 4 video and audio signals are muted.

Mute outputs one at a time.



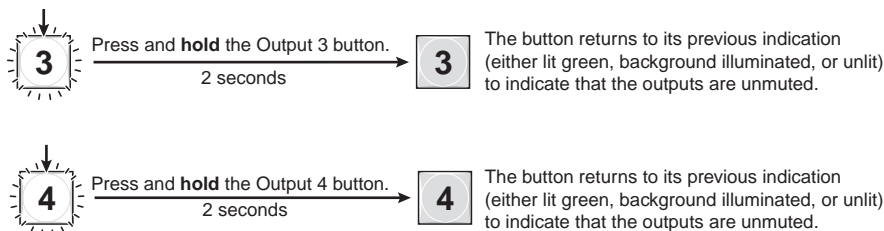
**Figure 3-53 — Mute the outputs**

**NOTE** If both **RGBHV/video** and **audio** are selected, the mute action toggles both the video and audio outputs. If either the video output or the audio output is already muted, the unmuted output is muted and the muted output is unmuted.

**NOTE** If both **RGBHV/video** and **audio** are selected and only video is muted, the output button flashes between green and amber. If only audio is selected, the output button flashes between red and amber.

5. **One at a time**, press and **hold** the Output 3 and then the Output 4 buttons (figure 3-54) for approximately 2 seconds until the buttons lights steadily. The output 3 and output 4 video and audio signals are unmuted.

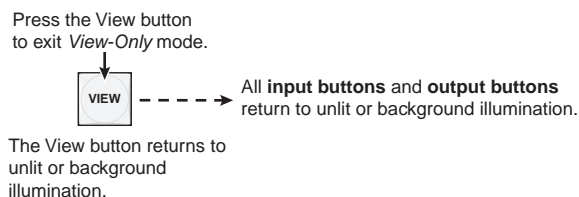
Unmute outputs one at a time.



**Figure 3-54 — Unmute the outputs**

**NOTE** If both **RGBHV/video** and **audio** are selected, the unmute action toggles both the video and audio outputs. If either the video output or the audio output is already unmuted, the muted output is unmuted and the unmuted output is muted.

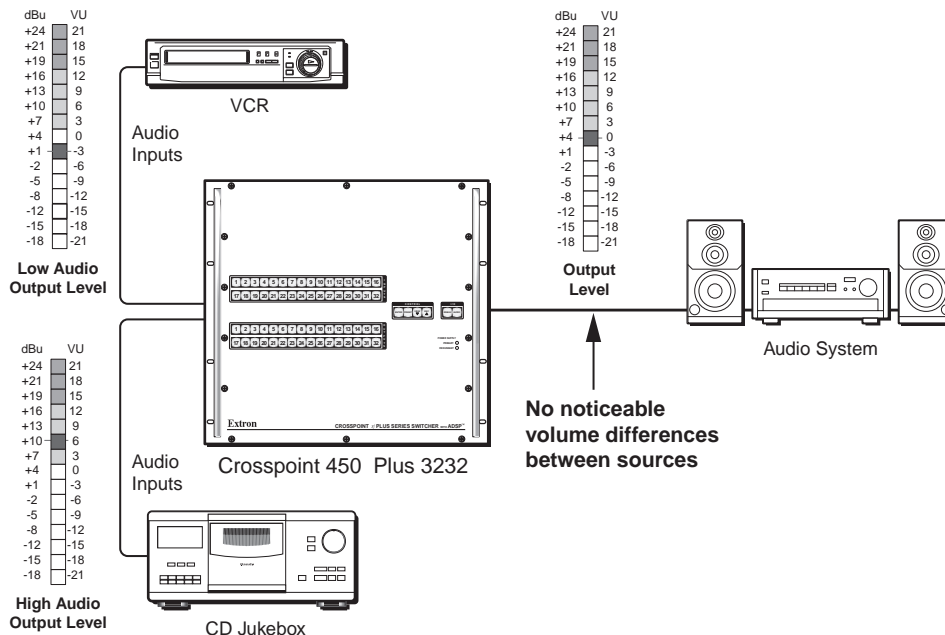
6. Press and release the View button to exit *View-Only* mode (figure 3-55).



**Figure 3-55 — Press the View button to exit View-Only mode**

## Viewing and adjusting the input audio level (audio models)

On models with audio, the audio level of each input can be displayed and adjusted through a range of -18 dB to +24 dB to ensure that there is no noticeable volume difference among sources (figure 3-56). The audio level can be adjusted from the front panel or under serial port or Ethernet control. The default audio input level is 0 dB.



**Figure 3-56 — Audio gain and attenuation**

1. Press the Esc button to clear any input buttons, output buttons, or control buttons that may be lit.
2. To enter *Audio* mode, press and **hold** the Audio button until the button begins to blink red, then release the button.
3. Press and release an input button to select an input. The output buttons display audio level and polarity (+ or -) for the selected input. Each lit output button indicates 1 dB of gain or attenuation. Green output buttons indicate a gain (+) audio level and red buttons indicate an attenuation (-) level.
4. Press and release the Esc (▲) and View (▼) buttons to increase and decrease the audio level.
5. Press and release the Audio button to exit the *Audio* mode. The Audio button stops blinking.

### **NOTE**

- Pressing the Enter or Preset button also exits Audio mode. Pressing the Preset button changes to Recall Preset mode.
- There is one audio level setting per input. The audio level setting is shared by the left and right audio inputs.
- The audio level settings are stored in non-volatile memory. When power is removed and restored, the audio level settings are retained.
- Exiting Audio mode by pressing the Audio button always returns the I/O configuration to RGBHV (CrossPoint 450 Plus switchers) or video (MAV Plus switchers) and audio selected for configuration.

## Operation, cont'd

### Example 10: Viewing and adjusting an input audio level

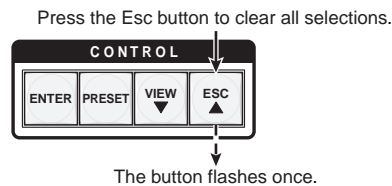
The following steps show an example in which an audio level is viewed and adjusted. The steps show the front panel indications that result from your action.

Audio gain and attenuation is displayed differently on different models.

- **Switchers with 32 output buttons** — Each output button indicates 1 dB when lit. See the table on page 3-37.
- **Switchers with 16 output buttons** — Each output button indicates 1 dB when blinking and 2 dB when lit. See the table on page 3-38.
- **Switchers with 8 output buttons** — Each output button indicates 1 dB when blinking slowly, 2 dB when blinking quickly, and 3 dB when lit. See the table on page 3-38.

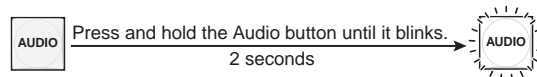
Because of the different gain and attenuation display schemes, the input audio levels that result from the following example are shown three times: as displayed on a 32-button switcher, on a 16-button switcher, and on an 8-button switcher. The 32-button displays show the actions that led up to the display. For simplicity, the 16-button and 8-button figures show the attenuation display only, not the actions that lead up to it.

1. Press and release the Esc button (figure 3-57).



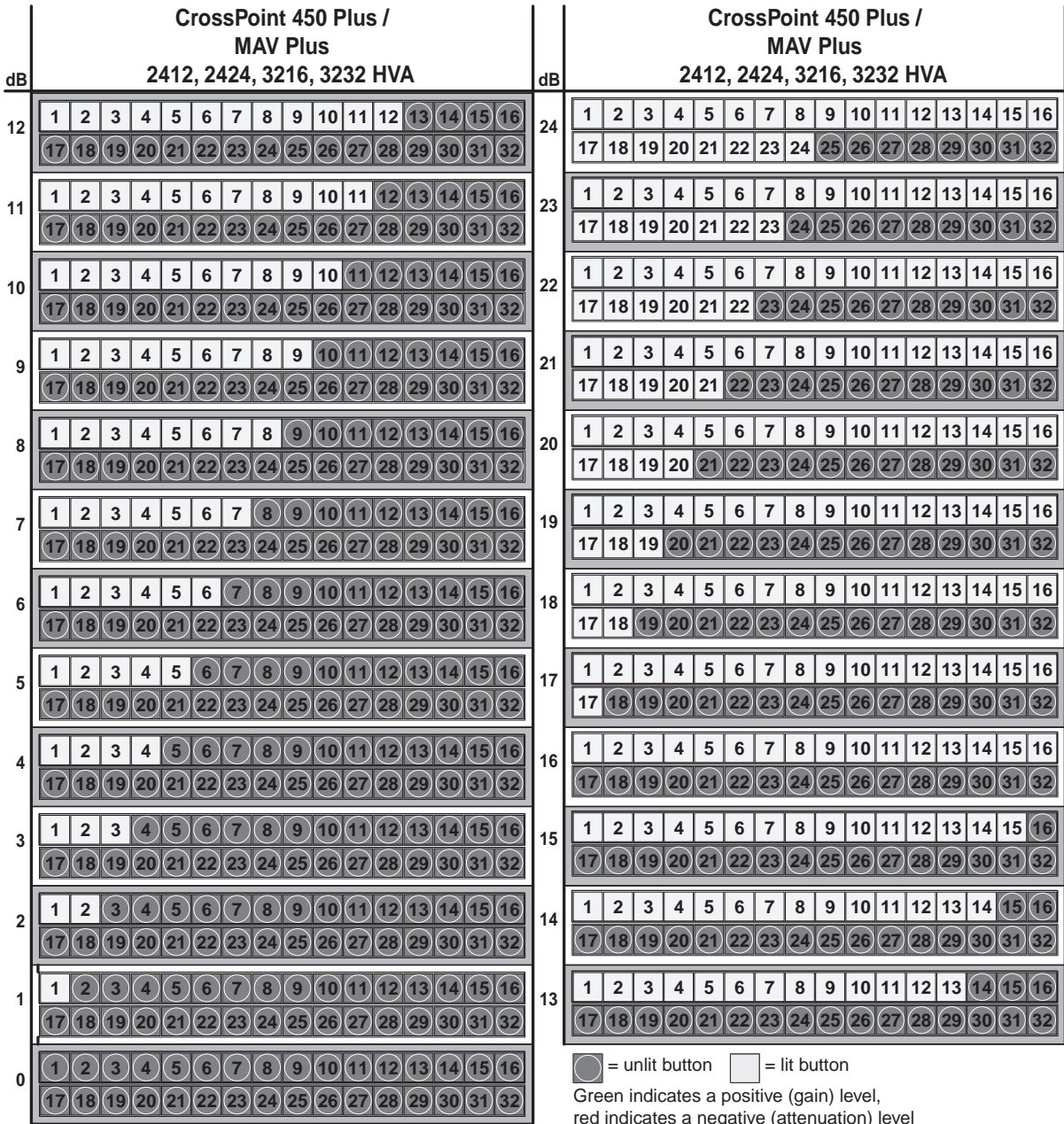
**Figure 3-57 — Clear all selections**

2. Press and **hold** the Audio button for approximately 2 seconds (figure 3-58).



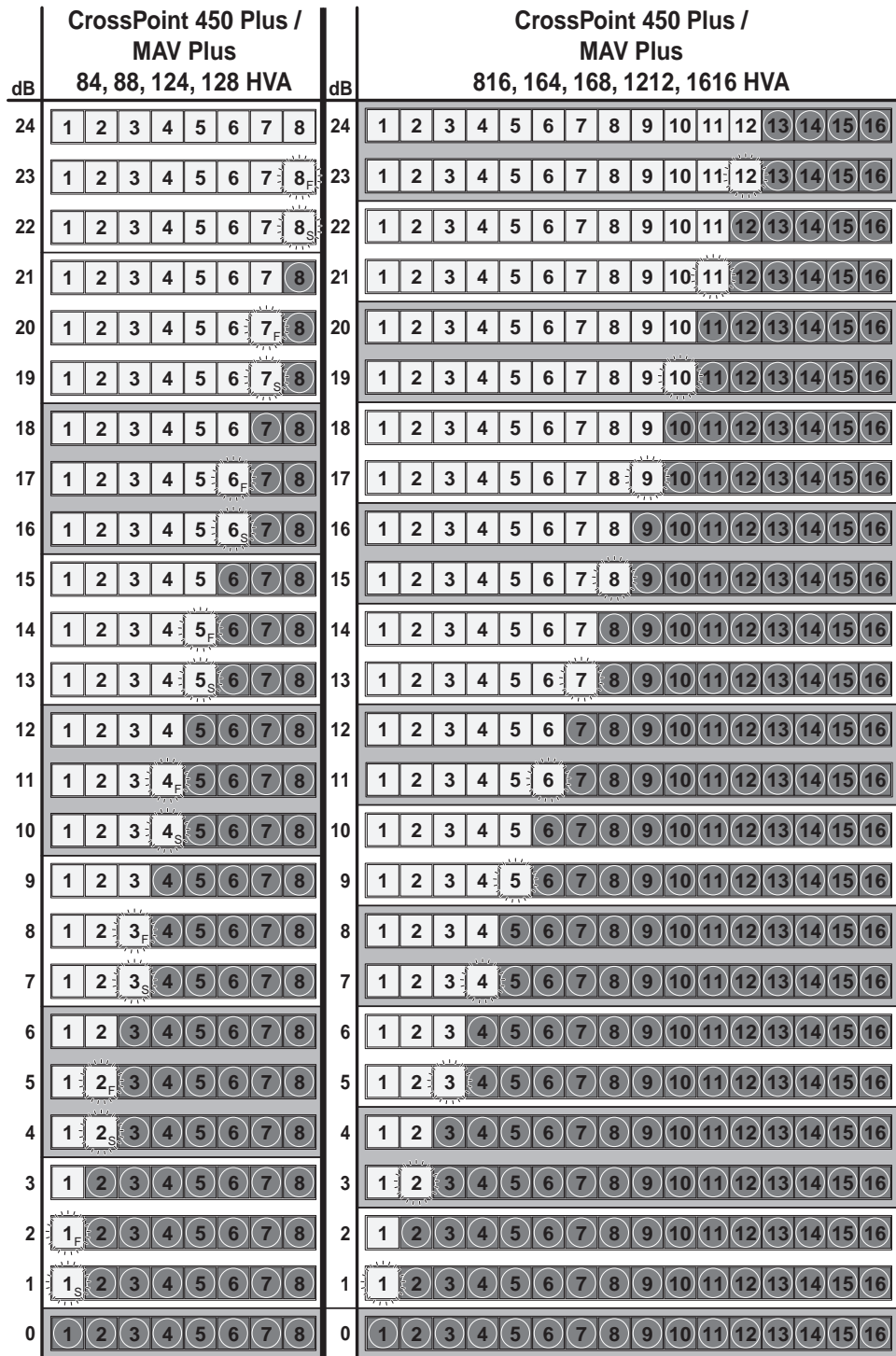
**Figure 3-58 — Select Audio mode**






### Input audio level adjustment displays



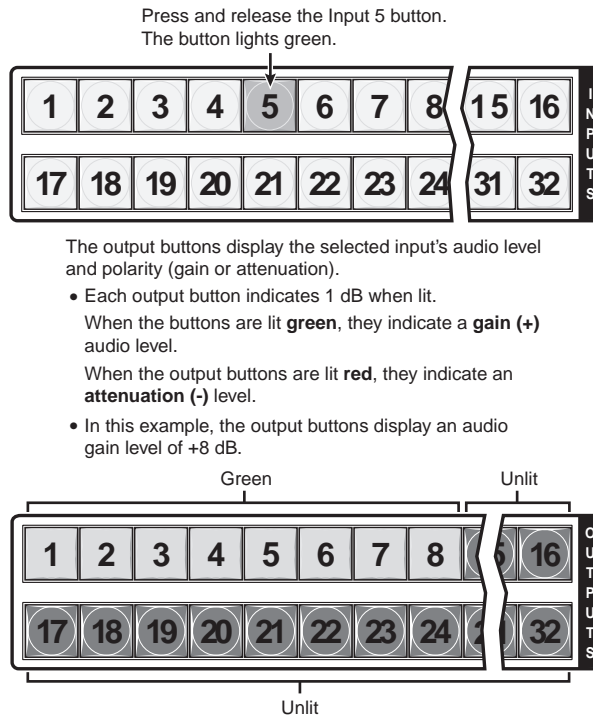
# Operation, cont'd

## Input audio level adjustment displays



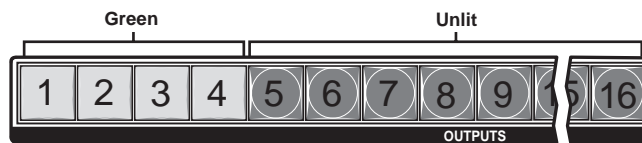
 = Unlit button   
  = Blinking button  
 = Slow blinking button   
  = Fast blinking button   
  = Lit button  
 Green indicates a positive (gain) level, red indicates a negative (attenuation) level

- Press and release the input 5 button (figure 3-59).



**Figure 3-59 — Select an input**

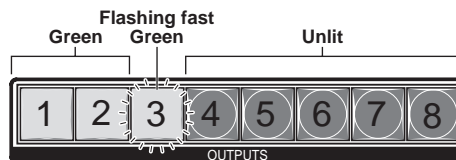
Figure 3-60 shows the same level (+8 dB) as in figure 3-59, but displayed on a 16-output-button switcher, such as a CrossPoint 450 Plus 816 HVA.



In this example, the output buttons display an audio gain level of +8 dB.

**Figure 3-60 — Level display on a 16-output-button switcher**

Figure 3-61 shows the same level (+8 dB) as in figure 3-59, but displayed on a 8-output-button switcher, such as a MAV Plus 84 HDA.



In this example, the output buttons display an audio gain level of +8 dB.

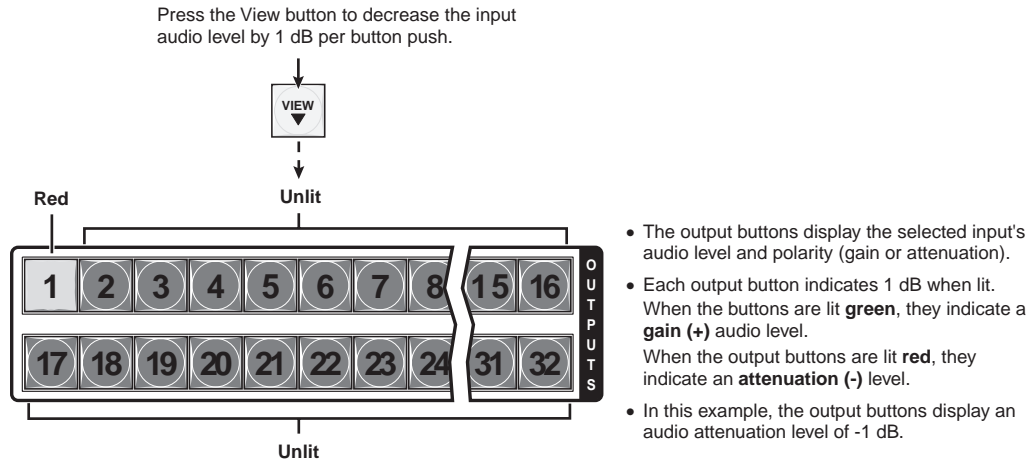
**Figure 3-61 — Level display on a 8-output-button switcher**

## Operation, cont'd

- Press and release the View (▼) button once (figure 3-62) to decrease the input audio level by 1 dB.

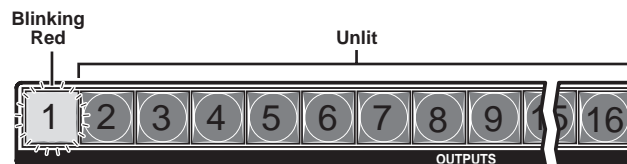
Press and release the View (▼) button several more times (figure 3-62) to decrease the input audio level by 1 dB per button push. Note the output button indication changes that occur each time the View (▼) button is pressed.

Figure 3-62 shows the result of pressing the View (▼) button a total of 9 times. Note that the level is now displayed in red to indicate a negative level.



**Figure 3-62 — Adjust the input audio level**

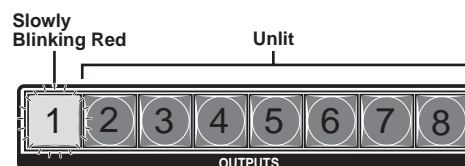
Figure 3-63 shows the same level (-1 dB) as in figure 3-62, but displayed on a 16-output-button switcher, such as a MAV Plus 1616 A.



In this example, the output buttons display an audio gain level of -1 dB.

**Figure 3-63 — Level display on a 16-output-button switcher**

Figure 3-64 shows the same level (-1 dB) as in figure 3-62, but displayed on an 8-output-button switcher, such as a CrossPoint 450 Plus 128 HVA.

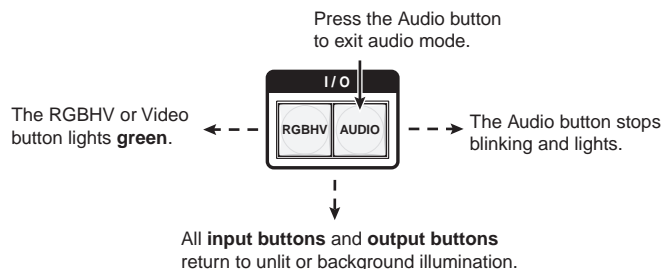


In this example, the output buttons display an audio gain level of +8 dB.

**Figure 3-64 — Level display on a 8-output-button switcher**



5. Press and release the Audio button (figure 3-65).



**Figure 3-65 — Deselect Audio mode**

## Viewing and adjusting the output volume (audio models)

On models with audio, the audio level of each output can be displayed and adjusted through a range of 100% (no attenuation) to 0% (maximum [76 dB] attenuation). The audio level can be adjusted from the front panel or under serial port or Ethernet control. The default volume is 100% (no attenuation).

**NOTE** *Output volume is protected when front panel lock mode 2 is selected. You can view the volume in lock mode 2, but not adjust it from the front panel.*

1. Press the Esc button to clear any input buttons, output buttons, or control buttons that may be lit.
2. To enter *Audio* mode, press and **hold** the Audio button until the button begins to blink red, then release the button.
3. Press and release an output button to select an output. The input buttons display the volume level for the selected output. The switchers indicate the volume differently, depending on number of input buttons, but as a general rule, the more buttons that are lit, the higher the volume. The fewer buttons that are lit, the lower the volume.

For a more detailed analysis of decoding the displayed value, see “Reading the displayed volume” on the next page.

4. Press and release the Esc (▲) and View (▼) buttons to increase and decrease the audio volume.
5. Press and release the Audio button to save the audio settings and exit the *Audio* mode. The Audio button stops blinking.

- NOTE**
- *There is one audio volume level setting per output. The audio level setting is shared by the left and right audio inputs.*
  - *The audio volume levels are stored in non-volatile memory. When power is removed and restored, the audio level settings are retained.*
  - *Exiting Audio mode by pressing the Audio button always returns the I/O buttons to RGBHV (CrossPoint 450 Plus) or Video (MAV Plus) lit green and Audio lit red.*
  - *Pressing the Enter or Preset button also exits Audio mode. Pressing the Preset button changes to Recall Preset mode.*



## Operation, cont'd

---

### Reading the displayed volume

**NOTE** *This section is a detailed look at reading the output volume display on the switcher's front panel. If you do not need to read the exact value of the volume setting, skip this section.*

There are 65 steps of volume attenuation, with 1 dB per step (button push), except for 0-to-1, which is 13 dB. At maximum attenuation, no input buttons are lit, 76 dB of attenuation is applied, and the audio output is effectively muted. At no attenuation, all input buttons are lit and the output volume is equal to the input signal plus any gain or attenuation that is applied to that specific input using the input audio level adjustment. See "Viewing and adjusting the input audio level (audio models)". Other than the minimum and maximum volume, the switchers indicate the volume differently, depending on number (12, 16, or 32) of input buttons. See the table on the next page to read the volume display for each display scheme.

For each display scheme, the input buttons blink or light sequentially to indicate the approximate volume of the selected output. Volume is defined as a percentage of the input audio signal that is applied to the output. From 0% of volume, the first Esc (▲) button push applies 5.5% of the input audio signal. From 5.5% on, each Esc (▲) push applies 1.5% more of the input audio signal to the output:

- **Push Esc (▲) button** —  $5.5\% + 1.5\% = 7\%$  volume
  - **Switchers with 12 and 16 input buttons** — Indicated by the Input 1 button blinking slowly.
  - **Switchers with 32 input buttons** — Indicated by the Input 1 button lit steadily.
- **Push Esc (▲) button twice** —  $7\% + 1.5\% + 1.5\% = 10\%$  volume
  - **Switchers with 12 input buttons** — Indicated by the Input 1 button blinking quickly.
  - **Switchers with 16 input buttons** — Indicated by the Input 1 button lit steadily.
  - **Switchers with 32 input buttons** — Indicated by the Input 1 and Input 2 button lit steadily.
- **Push Esc (▲) button nineteen times** —  $10\% + (19 \cdot 1.5\%) = 38.5\%$  volume
  - **Switchers with 12 input buttons** — Indicated by the Input 1 through 4 buttons lit steadily.
  - **Switchers with 16 input buttons** — Indicated by the Input 1 through 5 buttons lit steadily and the Input 6 button blinking.
  - **Switchers with 32 input buttons** — Indicated by the Input 1 through Input 11 buttons lit steadily and the Input 12 button blinking.

### Audio volume adjustment settings

Highest # input button lit			dB of attenuation	Output volume	Highest # input button lit			dB of attenuation	Output volume
12-input switcher	16-input switcher	32-input switcher			12-input switcher	16-input switcher	32-input switcher		
None	None	None	76	0%					
1 Slow blink	1	1	63	5.5%	6 Fast blink	9	17	31	53.5%
		1	62	7%	6		17	30	55%
1 Fast blink	1	2	61	8.5%	7 Slow blink	9	18	29	56.5%
		2	60	10%			18	28	58%
2 Slow blink	2	3	59	11.5%	7 Fast blink	10	19	27	59.5%
		3	58	13%			19	26	61%
2 Fast blink	2	4	57	14.5%	8 Slow blink	10	20	25	62.5%
		4	56	16%			20	24	64%
3 Slow blink	3	5	55	17.5%	8 Fast blink	11	21	23	65.5%
		5	54	19%			21	22	67%
3 Fast blink	3	6	53	20.5%	8	11	22	21	68.5%
		6	52	22%			22	20	70%
4 Slow blink	4	7	51	23.5%	9 Slow blink	12	23	19	71.5%
		7	50	25%			23	18	73%
4 Fast blink	4	8	49	26.5%	9 Fast blink	12	24	17	74.5%
		8	48	28%			24	16	76%
5 Slow blink	5	9	47	29.5%	10 Slow blink	13	25	15	77.5%
		9	46	31%			25	14	79%
5 Fast blink	5	10	45	32.5%	10 Fast blink	13	26	13	80.5%
		10	44	34%			26	12	82%
6 Slow blink	6	11	43	35.5%	11 Slow blink	14	27	11	83.5%
		11	42	37%			27	10	85%
6 Fast blink	6	12	41	38.5%	11 Fast blink	14	28	9	86.5%
		12	40	40%			28	8	88%
7 Slow blink	7	13	39	41.5%	12 Slow blink	15	29	7	89.5%
		13	38	43%			29	6	91%
7 Fast blink	7	14	37	44.5%	12 Fast blink	15	30	5	92.5%
		14	36	46%			30	4	94%
8 Slow blink	8	15	35	47.5%	13 Slow blink	16	31	3	95.5%
		15	34	49%			31	2	97%
8 Fast blink	8	16	33	50.5%	13 Fast blink	16	32	1	98.5%
		16	32	52%			32	0	100%

= blinking LED

## Operation, cont'd

---

When all input buttons are lit for any switcher model, the audio output is 100% of the audio input level.

Another way to view the volume level is to think in terms of the attenuation that is applied to the output. Attenuation reduction is indicated by the lit or blinking input buttons: when fewer input buttons are lit, attenuation is greater (and the volume is quieter).

- At minimum volume, all input buttons are unlit or background illuminated and 76 dB of attenuation is applied to the output. The audio output is effectively muted.
- The first step of volume increase causes the Input 1 button to blink (slowly, in the case of switchers with 12 input buttons). Attenuation is reduced by 13 dB (63 dB of attenuation is applied to the output).
- The second step of volume increase reduces the attenuation by an additional 1 dB (62 dB of attenuation is applied to the output). (On switchers with 32 input buttons the Input 1 button lights steadily.)
- Successive steps of volume increase cause consecutive buttons to first blink, then light steadily. (On switchers with 32 input buttons, each consecutive button indicates a 1 dB **attenuation reduction** when blinking and a 2 dB **attenuation reduction** when lit.)

**For example:** When lit steadily, the Input 3 button indicates the following, depending on the number of input buttons the switcher has:

- **Switchers with 12 input buttons** — 47 dB of attenuation when compared to the Input 3 button blinking quickly (48 dB to 50 dB of attenuation). The blinking Input 4 button (45 dB to 46 dB of attenuation) is at least 2 dB less than the fast blinking Input 3 button (48 dB – 46 dB) and at most 5 dB less (50 dB – 45 dB).
- **Switchers with 16 input buttons** — 52 dB of attenuation when compared to the Input 3 button blinking (53 dB to 55 dB of attenuation). The blinking Input 4 button (49 dB to 51 dB of attenuation) is at least 2 dB less than the fast blinking Input 3 button (53 dB – 51 dB) and at most and at most 6 dB less (55 dB – 49 dB).
- **Switchers with 32 input buttons** — 58 dB of attenuation when compared to the Input 3 button blinking (59 dB of attenuation). The blinking Input 4 button (57 dB of attenuation) is 2 dB less than the steadily-lit Input 2 button (59 dB - 57 dB).
- **On switcher with 32 input buttons**, the buttons' volume indications are additive.

**For example:** Input 1 lit (*23 dB* [22 dB + 1 dB] of **attenuation reduction**), Input 2 lit (*2 dB* [1 dB + 1 dB] of **attenuation reduction**), and Input 3 blinking (*1 dB* of **attenuation reduction**) indicate that the output **attenuation has been reduced** by a total of *25 dB* (*22 dB + 2 dB + 1 dB = 25 dB*).

- At full volume, no attenuation is applied to the output and all input buttons are lit steadily.

See the table on page 3-43 to read the volume display.

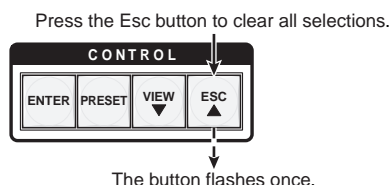
### Example 11: Viewing and adjusting an output volume level

The following steps show an example in which the audio output volume is viewed and adjusted. The steps show the front panel indications that result from your action.

Audio output volume is displayed differently on different models. See the table on page 3-43.

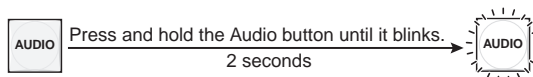
For this reason, figure 3-69 and figure 3-72 show the indications displayed on a switcher with 12 input buttons and 8 output buttons without duplicating all of the actions shown in figure 3-68 and figure 3-71, which show switchers with 32 input buttons. Figure 3-70 and figure 3-73 show the indications displayed on a switcher with 16 input buttons.

1. Press and release the Esc button (figure 3-66).



**Figure 3-66 — Clear all selections**

2. Press and **hold** the Audio button for approximately 2 seconds (figure 3-67).

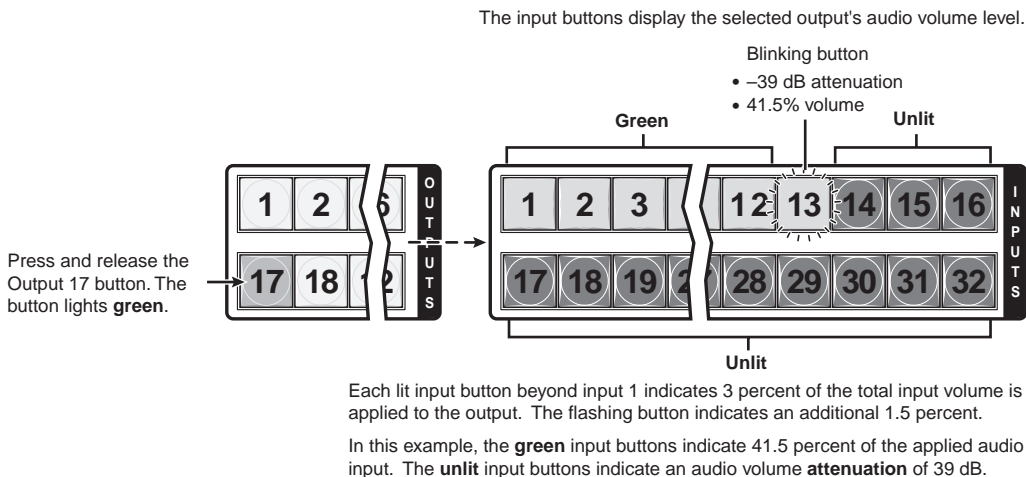


**Figure 3-67 — Select Audio mode**

**NOTE** *Volume is protected when front panel lock mode 2 is selected. You can view the volume in lock mode 2, but not change it from the front panel.*

*If front panel lock mode 2 is selected and you try to perform steps 3 and 4, the actions are ignored and the Enter, RGBHV/Video, and Audio buttons flash.*

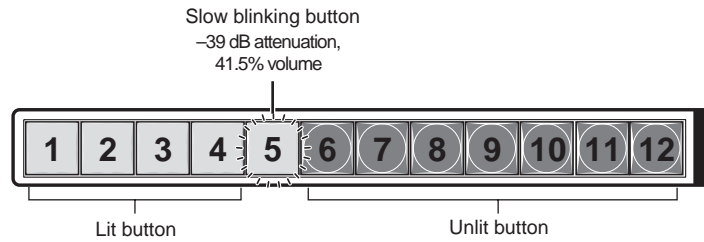
3. Press and release the output 17 button (figure 3-68).



**Figure 3-68 — Select output 17**

## Operation, cont'd

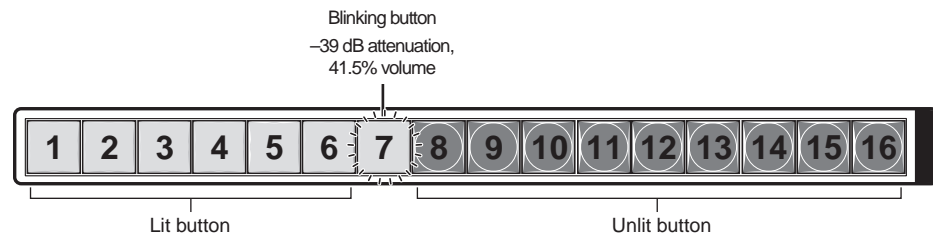
Figure 3-69 shows the same volume (41.5%) as in figure 3-68, but displayed on a 12-input-button switcher, such as a CrossPoint 450 Plus 128 HVA.



- The input LEDs display the selected output's audio volume level.
- In this example, the **lit/blinking** input buttons indicate 40 to 41.5 percent of the applied audio input.
- The **unlit/blinking** input buttons indicate an audio volume **attenuation** of 39 dB to 40 dB.

**Figure 3-69 — Volume display on a 12-input-button, 8-output button switcher**

Figure 3-70 shows the same volume (41.5%) as in figure 3-68, but displayed on a 16-input-button switcher, such as a CrossPoint 1616 HVA.



- The input LEDs display the selected output's audio volume level.
- In this example, the **lit/blinking** input buttons indicate 41.5 to 44.5 percent of the applied audio input.
- The **unlit/blinking** input buttons indicate an audio volume **attenuation** of 37 dB to 39 dB.

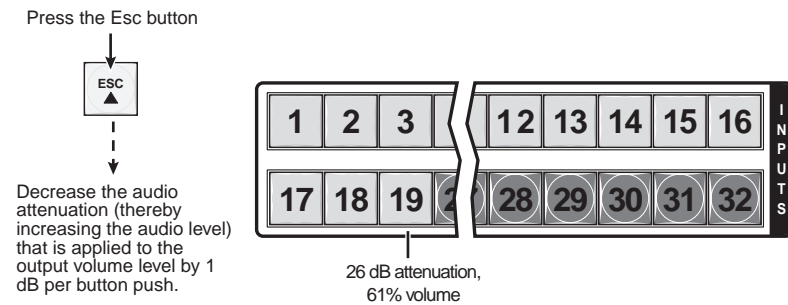
**Figure 3-70 — Volume display on a 16-input-button switcher**

- Press and release the Esc (▲) button once (figure 3-71) to increase the volume by 1.5%.

Press and release the Esc (▲) button several more times (figure 3-71) to increase the volume by 1.5% per button push. Note the input button indication changes that occur each time the Esc (▲) button is pressed and released.

**NOTE** You can press and hold the Esc (▲) or View (▼) button to ramp the level up or down by 3 dB per second to the high or low limit.

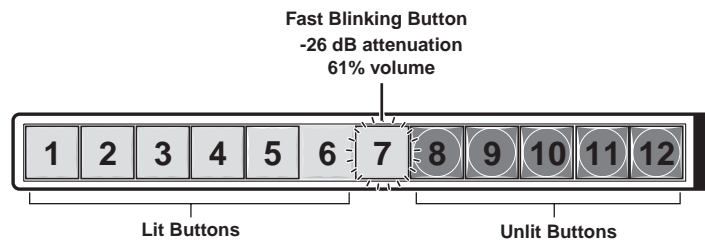
Figure 3-71 show the result of pressing the Esc (▲) button a total of 13 times.



- The input buttons display the selected output's audio volume level.
- Each lit input button beyond input 1 indicates 3 percent of the total input volume is applied to the output.
- In this example, the **green** input buttons display 61 percent of the applied audio input.
- The **unlit** input buttons indicate an audio volume **attenuation** of 26 dB.

**Figure 3-71 — Adjust the output audio volume**

Figure 3-72 shows the same volume (61%) as in figure 3-71, but displayed on a 12-input-button switcher, such as a CrossPoint 450 Plus 450 128 HVA.

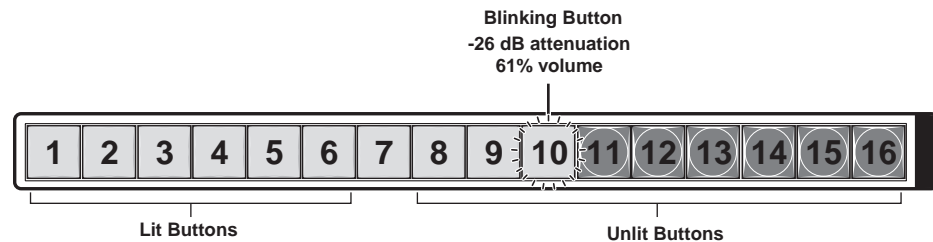


- The input LEDs display the selected output's audio volume level.
- In this example, the **lit/blinking** input buttons indicate 59.5 to 61 percent of the applied audio input.
- The **unlit/blinking** input buttons indicate an audio volume **attenuation** of 26 dB to 27 dB.

**Figure 3-72 — Volume display on a 12-input-button, 8-output button switcher**

## Operation, cont'd

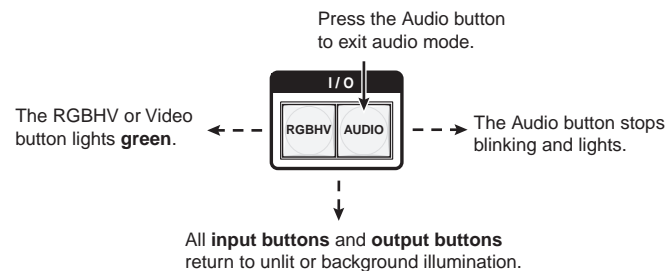
Figure 3-73 shows the same volume (61%) as in figure 3-71, but displayed on a 16-input-button switcher, such as a CrossPoint 1616 HVA.



- The input LEDs display the selected output's audio volume level.
- In this example, the **lit/blinking** input buttons indicate 59.5 to 62.5 percent of the applied audio input.
- The **unlit/blinking** input buttons indicate an audio volume **attenuation** of 25 dB to 27 dB.

**Figure 3-73 — Volume display on a 16-input-button switcher**

5. Press and release the Audio button (figure 3-74).



**Figure 3-74 — Deselect Audio mode**

### Setting the front panel locks (*Executive modes*)

The matrix switchers have three levels of front panel security lock that limit the operation of the switcher from the front panel. The three levels are:

- **Lock mode 0** — The front panel is completely unlocked. All front panel functions are available.
- **Lock mode 1** — All changes are locked from the front panel (except for setting *Lock mode 2*). Some functions can be viewed.
- **Lock mode 2** — Basic functions are unlocked. Advanced features are locked and can be viewed only.

Basic features consist of:

- Making ties
- Saving and recalling presets
- Setting input audio gain and attenuation
- Changing *Lock modes*

Advanced features consist of:

- Creating I/O groups
- Setting RGB delay
- Setting video and audio output mutes
- Setting audio output volume
- Setting the rear panel remote port protocol and baud rate

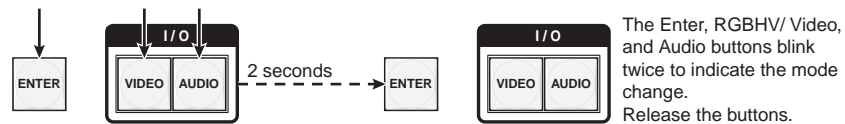
**NOTE** The switcher ships from the factory in Lock mode 2.

### Selecting Lock mode 2 or toggling between mode 2 and mode 0

**NOTE** If the switcher is in Lock mode 0 or mode 1, this procedure selects mode 2.  
If the switcher is in Lock mode 2, this procedure selects mode 0 (unlocks the switcher).

To toggle the lock on and off, press and hold the Enter button, the RGBHV (CrossPoint 450 Plus) or Video (MAV Plus) button, and the Audio button for approximately two seconds (figure 3-75).

Press and **hold** the Enter, RGBHV /Video, and Audio buttons simultaneously to turn on Lock mode 2 or to toggle between mode 2 and mode 0.



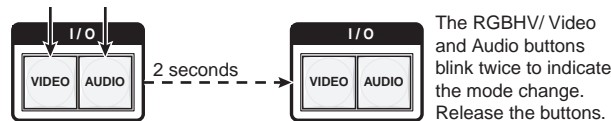
**Figure 3-75 — Toggle front panel lock on (mode 2) or off (mode 0)**

### Selecting Lock mode 2 or toggling between mode 2 and mode 1

**NOTE** If the switcher is in Lock mode 0 or mode 1, this procedure selects mode 2.  
If the switcher is in Lock mode 2, this procedure selects mode 1.

To toggle the lock on and off, press and hold the RGBHV (CrossPoint 450 Plus) or Video (MAV Plus) button and the Audio button for approximately two seconds (figure 3-76).

Press and **hold** the RGBHV /Video and Audio buttons simultaneously to turn on Lock mode 2 or to toggle between mode 1 and mode 2.



**Figure 3-76 — Toggle front panel lock between mode 2 and mode 1**

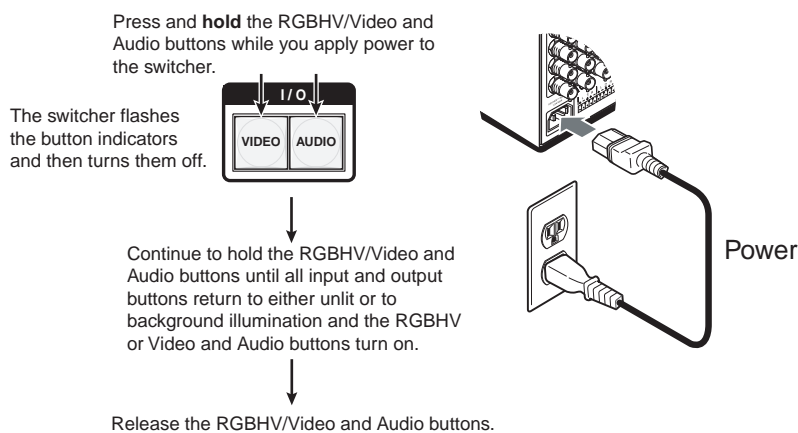


### Performing a system reset from the front panel

The front panel reset is identical to the `Esc/ZXXX← SIS` command (see chapter 4, “Programmer’s Guide”). A system reset clears all ties and presets, all video and audio mutes, resets all I/O grouping, sets all input audio levels to unity gain (+0 dB), and sets all output volume levels to 100% (0 dB of attenuation).

Reset the switcher to the factory default settings by pressing and **holding** the RGBHV (CrossPoint 450 Plus) or Video (MAV Plus) button and Audio button **while** you apply AC power to the switcher (figure 3-77).

**NOTE** *System reset does not reset the Internet protocol (IP) settings or replace user-installed firmware.*

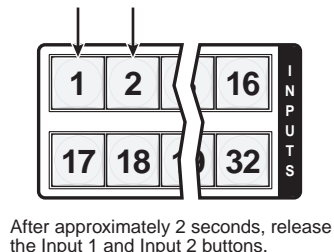


**Figure 3-77 — System reset**

### Background illumination

The buttons on the front panel can be set to provide amber background illumination at all times or the background illumination can be turned off. To toggle the background illumination on or off, press and hold the Input 1 and Input 2 buttons for approximately two seconds (figure 3-78).

Press and **hold** the Input 1 and Input 2 buttons simultaneously to toggle background illumination mode on or off.



**Figure 3-78 — Toggle background illumination on or off**

## Selecting the rear panel Remote port protocol and baud rate

**NOTE** This procedure affects the rear panel Remote port only. The front panel Configuration (RS-232) port's variables can be changed under serial port or Ethernet control only. See the Command/Response table for IP SIS commands, in chapter 4, "Programmer's Guide", to configure either port under SIS control.

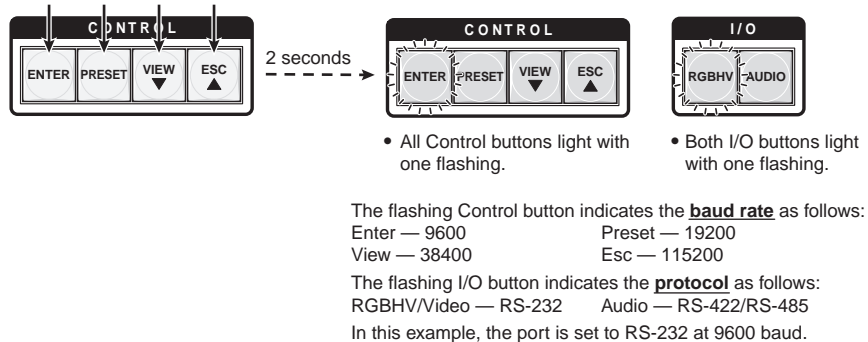
**NOTE** The Remote port settings are protected when front panel lock mode 2 is selected. You can view the settings in lock mode 2, but not adjust them from the front panel.

The switcher can support either RS-232 or RS-422 serial communication protocol, and operate at 9600, 19200, 38400, and 115200 baud rates. The settings of these variables can be viewed and changed from the front panel.

View and configure the switcher's serial communications settings as follows:

1. To enter *Serial Port Configuration* mode, simultaneously press and **hold all** Control buttons (Enter, Preset, View, and Esc) (figure 3-79).

Press and **hold** the Enter, Preset, View, and Esc buttons.



**Figure 3-79 — RS-232/RS-422 and baud rate display**

2. Release the Control buttons.

## Operation, cont'd

**NOTE** The serial port settings are protected when front panel lock mode 2 is selected. You can view the settings in lock mode 2, but not change them from the front panel.

If front panel lock mode 2 is selected and you try to perform step 3, the actions are ignored and the Enter, RGBHV/Video, and Audio buttons flash.

3. **To change a value**, press and release the button that relates to the desired value (figure 3-80).

Press and release the button(s) to configure the port as follows:

**Baud rate:**

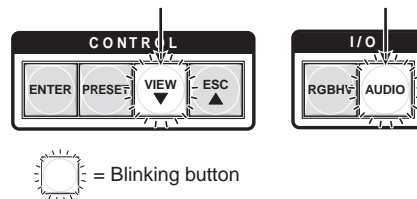
Enter — 9600                      Preset — 19200  
View — 38400                     Esc — 115200

**Serial protocol:**

RGBHV/Video — RS-232      Audio — RS-422/RS-485

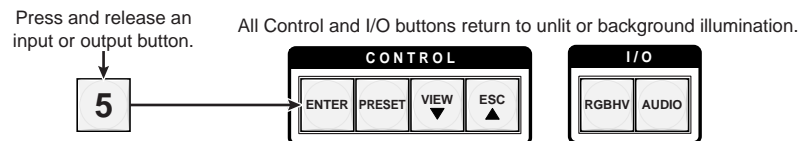
The selected buttons blink and the others remain lit.

In this example, the port is set to RS-422 at 38400 baud.



**Figure 3-80 — RS-232/RS-422 and baud rate selection**

4. Press and release an input or output button to exit the *Serial Port Configuration* mode (figure 3-81).



**Figure 3-81 — Exit Serial Port Configuration mode**

---

## Rear Panel Controls

The rear panel has a Reset button that initiates four levels of matrix switcher resets. Press and hold the button while the switcher is running or while you apply power to the switcher for different reset levels.

### Performing soft system resets

The CrossPoint 450 Plus and MAV Plus switchers have three soft resets available that restore various tiers of switcher settings to their default settings.

- **Events (mode 3) reset** — This function toggles the monitoring of events on or off (if events monitoring was on, this function turns it off; if it was off, it is turned on).
- **IP settings (mode 4) reset** — The IP settings reset performs the following functions:
  - Enables Arp program capability
  - Resets the IP address to the factory default (192.168.254.254)
  - Resets the subnet mask to the factory default (255.255.0.0)
  - Resets the gateway address to its factory default (0.0.0.0)
  - Turn DHCP off
  - Turn events off

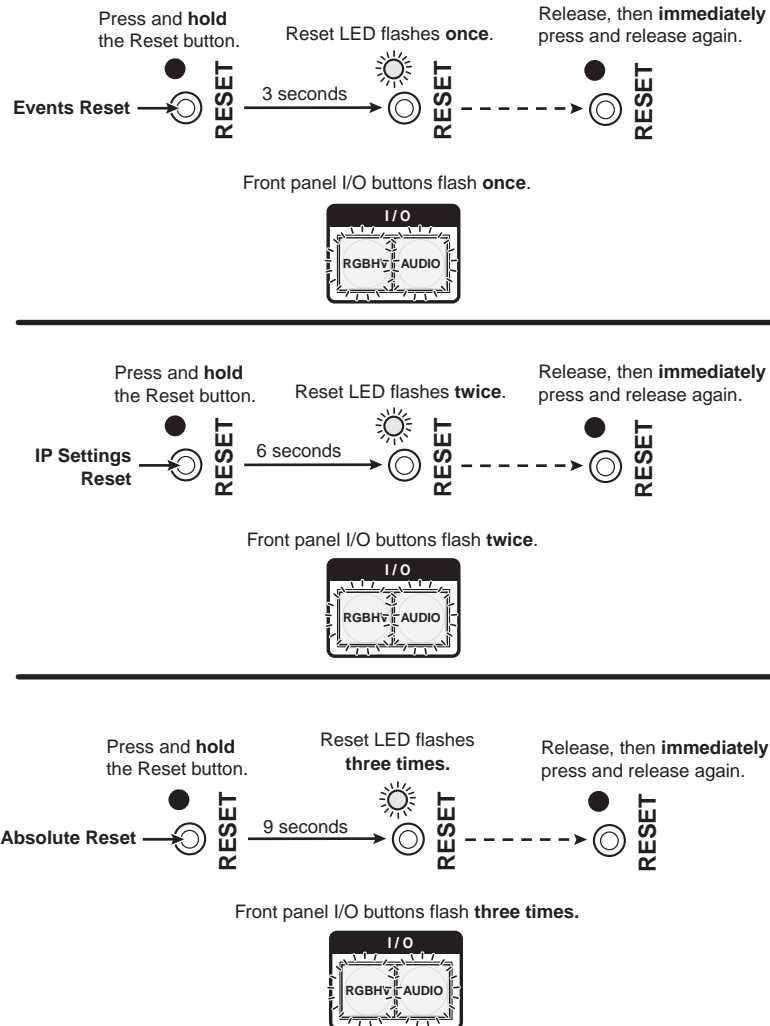
**NOTE** *IP settings reset does not replace any user-installed firmware.*

- **Absolute (mode 5) reset** — Absolute reset restores the switcher to the default factory conditions. This function is identical to the `Esc Z Q Q Q ← SIS` command, see chapter 4, “Programmer’s Guide”).

Perform a soft reset of the switcher as follows:

## Operation, cont'd

1. Press and **hold** the Reset button until the front panel RGBHV (CrossPoint 450 Plus)/Video (MAV Plus) and Audio buttons blink once (events reset), twice (system reset), or three times (absolute reset) (figure 3-82).



**NOTE** The Reset button on switchers with matrix sizes of 24 x 12 and above have a different appearance and do not have a rear panel Reset LED.

**Figure 3-82 — Whole switcher and absolute resets**

2. Release the Reset button and then immediately press and **hold** the Reset button until the LED flashes three times. Release the Reset button. Nothing happens if the second momentary press does not occur within 1 second.

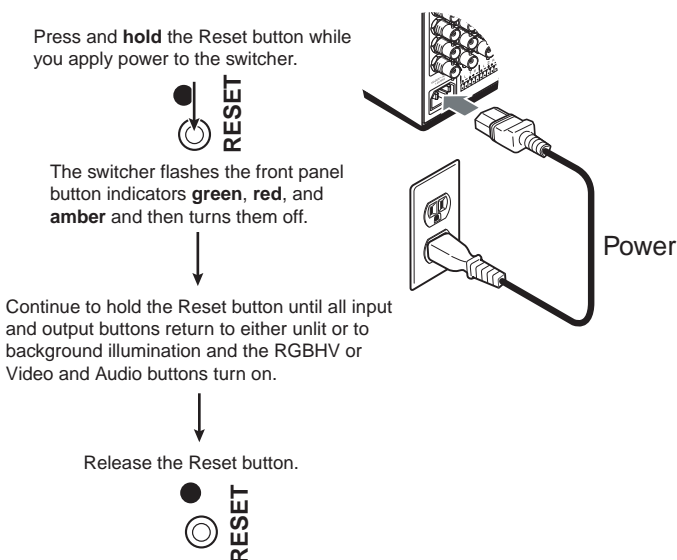
### Performing a hard reset

The hard reset function restores the switcher to the base firmware that it shipped with. After a hard reset, events do not automatically start, but user settings and files are restored. Perform a hard reset as follows:

---

**NOTE** *The hard reset restores the factory-installed firmware. The switcher reverts to that factory firmware the next time power is cycled off and on unless a firmware update is performed before the power cycle.*

1. If necessary, turn off power to the switcher.
2. Press and **hold** the Reset button on the rear panel **while** you apply AC power to the switcher (figure 3-83).



**NOTE** *The Reset button on switchers with matrix sizes of 24 x 12 and above have a different appearance and do not have a rear panel Reset LED.*

**Figure 3-83 — Hard reset**

### Optimizing the Audio (Audio Switchers)

Each individual input audio level can be adjusted within a range of -18 dB to +24 dB, so there are no noticeable volume differences between sources and for the best headroom and signal-to-noise ratio. Adjust the audio gain and attenuation as follows:

1. Connect audio sources to all desired inputs and connect the audio outputs to output devices such as audio players. See “Audio input and output connections (audio models only)”, in chapter 2, “Installation”. For best results, wire all of the inputs and the outputs balanced.
2. Power on the audio sources, the switcher, and the audio players.
3. Switch among the inputs (see “Creating ties”, in this chapter), listening to the audio with a critical ear or measuring the output audio level with test equipment, such as a VU meter.
4. As necessary, adjust the input audio level of each input (see “Viewing and adjusting the input audio level (audio models)”, in this chapter) so that the approximate output level is the same for all selected inputs.
5. As necessary, adjust the output audio level of each input (see “Viewing and adjusting the output volume (audio models)”, in this chapter).

### Troubleshooting

This section gives recommendations on what to do if you have problems operating the CrossPoint 450 Plus or MAV Plus switcher, and it describes an actual image problem that Extron has encountered.

#### General checks

1. Ensure that all devices are plugged in and powered on. The switcher is receiving power if one of the front panel Power Supply LEDs is lit green.
2. Check to see if one or more outputs are muted.
3. Ensure an active input is selected for output on the switcher.
4. Ensure that the proper signal format is supplied.
5. Check the cabling and make corrections as necessary.
6. Call the Extron S<sup>3</sup> Sales & Technical Support Hotline if necessary.

#### Plasma display S-video problem (CrossPoint 450 Plus switchers only)

Extron has encountered a problem when a CrossPoint 450 Plus switcher routes S-video that is output by some video conference codecs. Some codecs change the DC offset on the chrominance (C) so that it is very different from the level on the luminance (Y). This can cause a plasma display to come up in the wrong size mode.

With the matrix switcher taken out of the system, the plasma works fine. It looks like a problem with the matrix switcher, but **it is not**. The matrix switcher boosts the bad codec output, which makes the plasma go to the wrong setting.

**Solution:** Try placing an Extron video DC block adapter, part #26-495-01, on the luminance (Y) input to the switcher from the codec.

## Configuration Worksheets

Rather than trying to remember the configuration for each preset, use worksheets to record this information. Make copies of the blank worksheet on page 3-61 (32-input button and -output button switchers) and page 3-63 (16-button switchers) and use one for each preset configuration. The worksheet accommodates all of the CrossPoint 450 Plus and MAV Plus models. Cross out all unused or inactive inputs and outputs. Use different colors for video and audio.

### Worksheet example 1: System equipment

Figure 3-84 shows a worksheet for a CrossPoint 450 Plus 2424 HVA in a fictional organization with the system hardware annotated. Inputs 10, 11, and 21 through 24 have no connections in this organization, so they have been crossed out on the worksheet. A CrossPoint 450 Plus 2424 does not have inputs 25 through 32, so they are crossed out. Similarly, outputs 7, 14, 15, 16, and 25 through 32 are crossed out.

Inputs include PCs, an audio CD player, cameras, and an Extron VTG 300. Output devices include monitors, front and rear projectors, a stereo, and a VCR for recording presentations.

The Extron VTG 300 video test generator connected to input 12 enables a video test pattern to be sent to one, several, or all output devices for problem isolation or adjustment purposes. An audio test tape or CD could be used in a similar manner to check out the audio components.

Input sources															
Camera main podium	Camera #2	Podium Mic	Laptop RGB 201 Rxi	Audio CD	Classroom #1 VCR (DVS 406)	Classroom #2 VCR (DVS 406)	PC1 RGB 201 Rxi	Rack DVD (DVS)	X	X	VTG 300	Floorbox #1	Floorbox #2	Floorbox #3	Floorbox #4
1	2	3	4	5	6	7	8	9	10	11	12	13	14	15	16
17	18	19	20	21	22	23	24	25	26	27	28	29	30	31	32
Demo rack #1 USP 405	Demo rack #2 USP 405	Demo rack #3 USP 405	Demo rack #4 USP 405	X	X	X	X	X	X	X	X	X	X	X	X

Output destinations															
Main Hall Pj#1	Main Hall Pj#2	Podium monitor	Conf. room	Sound system #2	VCR (USP 405)	X	Lobby monitor	Class room #1 monitor	Class room #2 monitor	Demo room Pj #1	Demo rack monitor	Demo rack switcher	X	X	X
1	2	3	4	5	6	7	8	9	10	11	12	13	14	15	16
17	18	19	20	21	22	23	24	25	26	27	28	29	30	31	32
Demo wallbox #1	Demo wallbox #2	Demo wallbox #3	Demo wallbox #4	Demo wallbox #5	Demo wallbox #6	Demo wallbox #7	Demo wallbox #8	X	X	X	X	X	X	X	X

Preset # 1 Title: Worksheet Example Video: — Audio: --  
 Fill in the preset number, use colors or dashes, etc. to make connecting lines.  
 Indicate if the configuration is for Video, Audio, or both.

Figure 3-84 — Worksheet example 1: System equipment



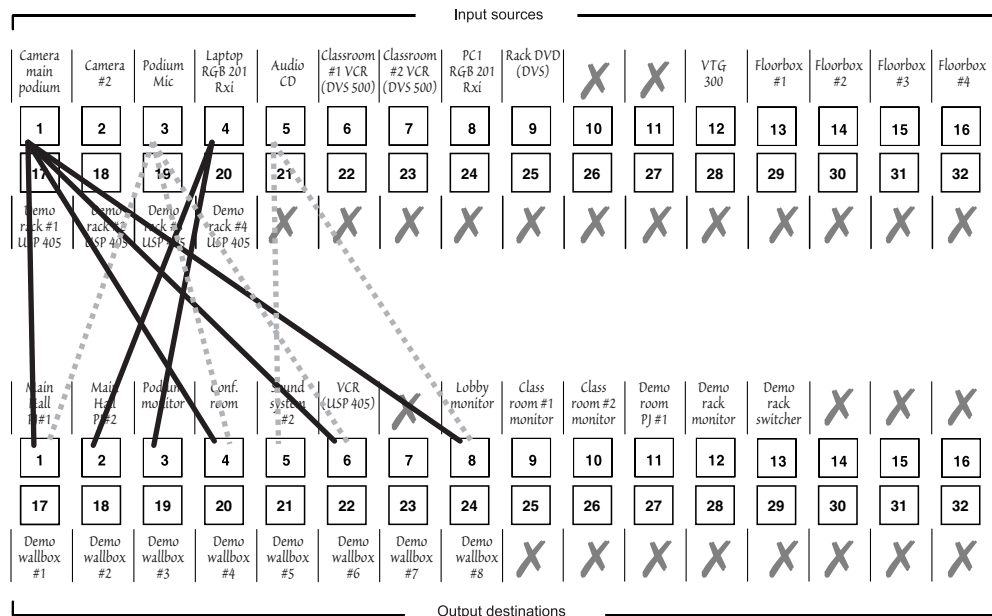
# Operation, cont'd

## Worksheet example 2: Daily configuration

Figure 3-85 continues from worksheet example 1 by showing the video and audio ties that make up the configuration of preset 1. A solid ink line shows video ties and a dashed pencil line shows the audio ties.

In this example:

- The image of the presenter, from the main podium camera (input 1), is displayed:
  - In the main hall (output 1)
  - In the conference room (output 4) to the overflow crowd
  - In the lobby (output 8)
  - Tied to the VCR (output 6)
- The presenter has a presentation on her laptop computer (input 4) that is scan converted and displayed:
  - In the main hall (output 2)
  - Locally on the podium (output 3)
- The audio from her microphone (input 3) is played:
  - In the hall (output 1)
  - In the conference room (output 4)
  - Sent to the VCR
- Classical music from the CD player (input 5) is played:
  - In the background in the main hall on sound system #2 (output 5)
  - In the lobby (output 8)



Preset # 1 Title: Worksheet Example Video: — Audio: - -  
 Fill in the preset number, use colors or dashes, etc. to make connecting lines.  
 Indicate if the configuration is for Video, Audio, or both.

**Figure 3-85 — Worksheet example 2: Daily configuration**

### Worksheet example 3: Test configuration

The A/V system in our fictional organization needs to be fine tuned on a regular basis. Figure 3-86 shows a typical test configuration, with an Extron video test generator (input 12) generating a test pattern to all monitors (outputs 1, 2, 3, 4, 8, 9, 10, and 12). Sound checks are run from the CD player (input 5) to all audio systems (outputs 1, 2, 4, 5, and 8).

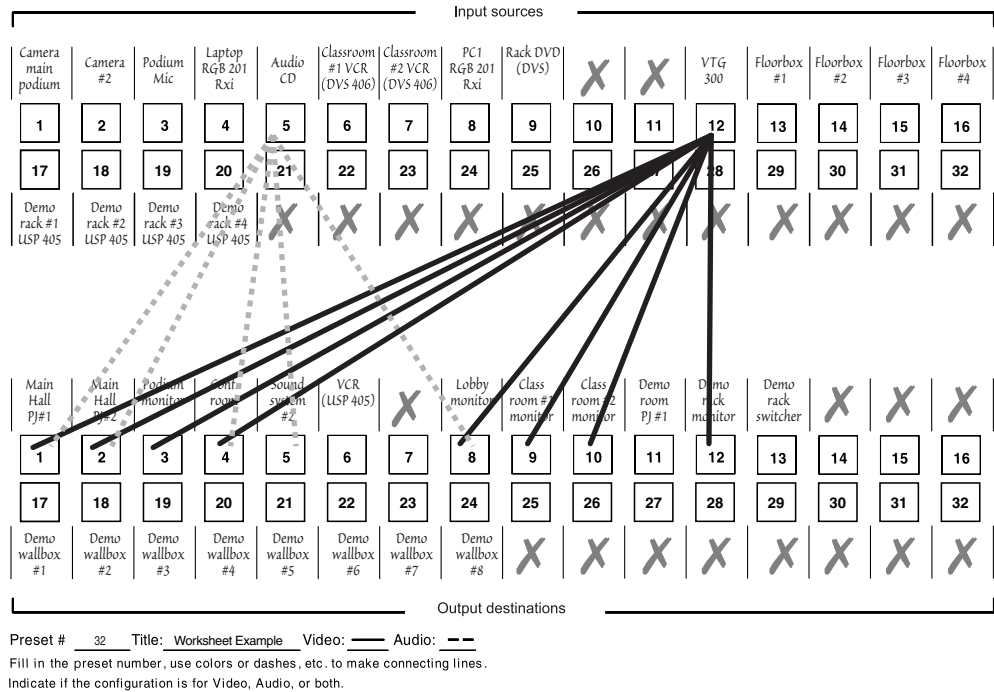
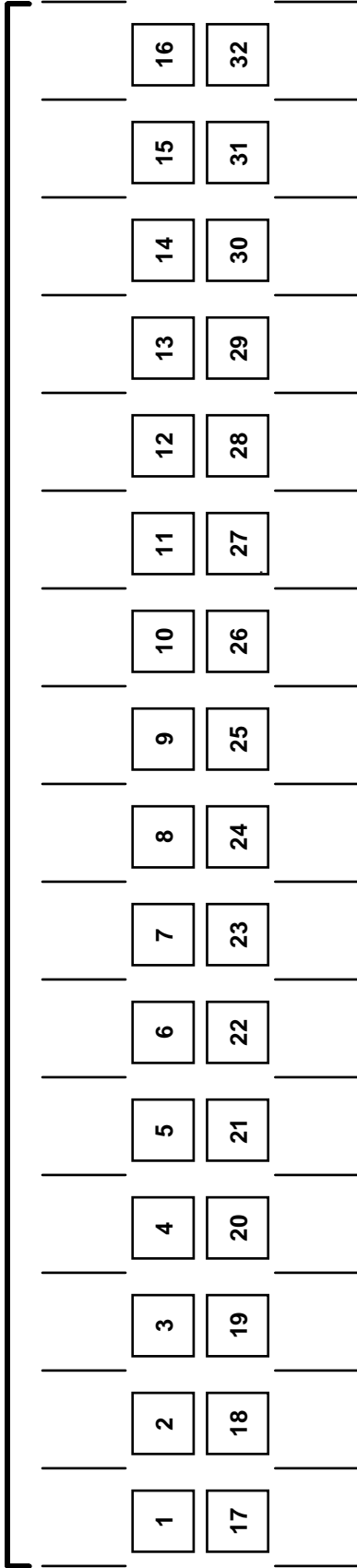


Figure 3-86 — Worksheet example 3: Test configuration

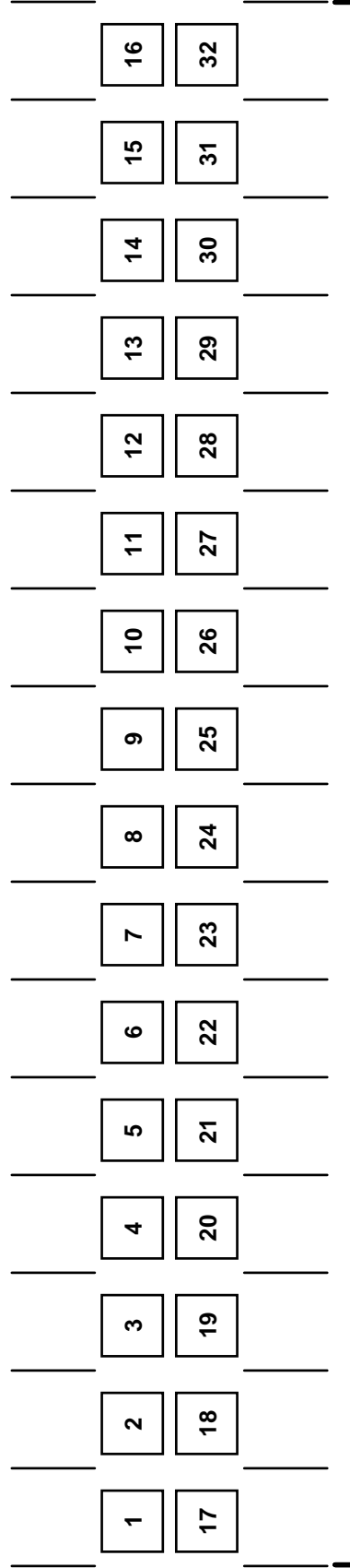
## **Operation, cont'd**

---

Input sources



Output destinations



Preset # \_\_\_\_\_ Title: \_\_\_\_\_ Video: \_\_\_\_\_ Audio: \_\_\_\_\_  
 Fill in the preset number and use colors, or dashes, etc. to make connecting lines.  
 Indicate if the configuration is for Video, Audio, or both.

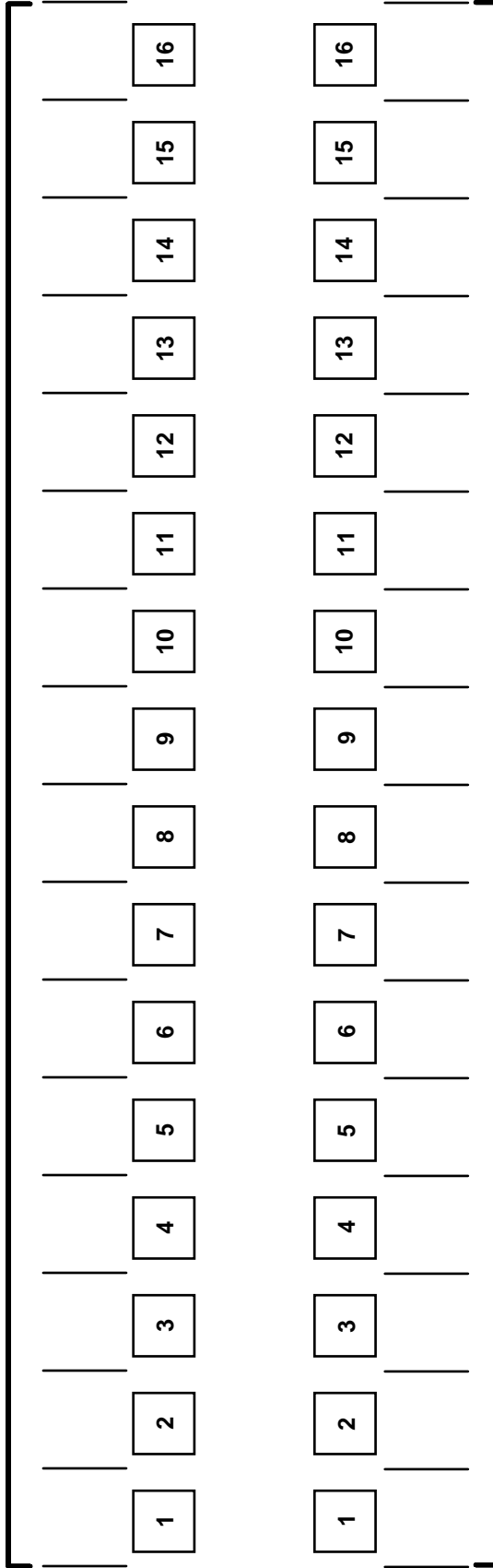
**32-button switchers configuration worksheet**

## **Operation, cont'd**

---

*This page was intentionally left blank.*

Input sources



Output destinations

Preset # \_\_\_\_\_ Title: \_\_\_\_\_ Video: \_\_\_\_\_ Audio: \_\_\_\_\_  
Fill in the preset number and use colors, or dashes, etc. to make connecting lines.  
Indicate if the configuration is for video, audio, or both.

### 16-button and smaller switchers configuration worksheet

## Operation, cont'd

---

*This page was intentionally left blank.*



# CrossPoint 450 Plus and MAV Plus Switchers

# 4 Chapter Four

## Programmer's Guide

Serial Ports

Ethernet Link

Host-to-Switcher Instructions

Switcher-Initiated Messages

Switcher Error Responses

Using the Command/Response Tables

Command/Response Table for SIS Commands

Command Response Table for IP SIS Commands

Special Characters



# Programmer's Guide

## Serial Ports

The switcher has one or two serial ports that can be connected to a host device such as a computer running the HyperTerminal utility, an RS-232 capable PDA, or a control system. These ports make serial control of the switcher possible. The serial ports are:

- The rear panel Remote (RS-232 or RS-422) port, a 9-pin D female connector
- The front panel Configuration (RS-232) port, a 2.5 mm mini stereo jack (matrix sizes up to 1616 only)

The default protocol for both ports is as follows:

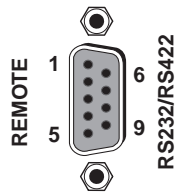
- 9600 baud
- no parity
- 8 data bits
- 1 stop bit
- no flow control

The ports can be configured to operate at the 9600, 19200, 38400, or 115200 baud rate.

**NOTE** *These two ports are independent of one another. A front panel Configuration port connection and a rear panel Remote port connection can both be active at the same time.*

**NOTE** *The switcher can operate at 9600, 19200, 38400, or 115200 baud rates, but Extron recommends leaving these ports at 9600 baud only.*

## Rear panel Remote port



Pin	All Models		84 through 1616 Matrix Sizes		2412 through 3232 Matrix Sizes	
	RS-232	Function	RS-422	Function	RS-422	Function
1	—	Not used	—	Not used	TX+	Transmit data (+)
2	TX	Transmit data	TX-	Transmit data (-)	TX-	Transmit data (-)
3	RX	Receive data	RX-	Receive data (-)	RX+	Receive data (+)
4	—	Not used	—	Not used	RX-	Receive data (-)
5	Gnd	Signal ground	Gnd	Signal ground	Gnd	Signal Ground
6	—	Not used	—	Not used	—	Not used
7	—	Not used	RX+	Receive data (+)	—	Not used
8	—	Not used	TX+	Transmit data (+)	—	Not used
9	—	Not used	—	Not used	—	Not used

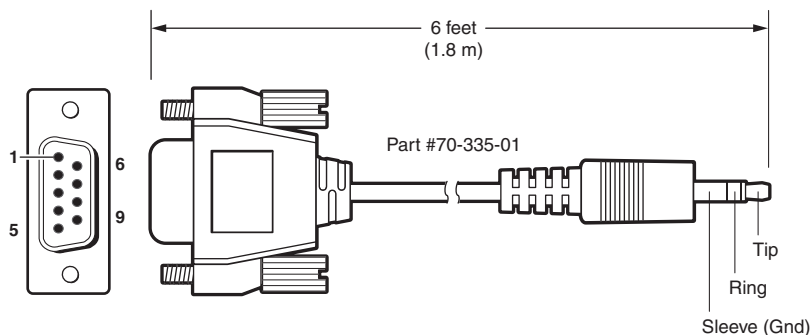
**Figure 4-1 — Remote connector pin assignments**

**NOTE** *The rear panel Remote port can support either RS-232 or RS-422 serial communication protocol, and can operate at 9600, 19200, 38400, or 115200 baud rates. See “Selecting the rear panel Remote port protocol and baud rate” in chapter 3, “Operation”, to configure the rear panel Remote port from the front panel.*

## Front panel Configuration port (matrix sizes up to 1616 only)

**NOTE** This port is hardwired for RS-232 only.

The optional 9-pin D to 2.5 mm mini jack TRS RS-232 cable, part #70-335-01 (figure 4-2) can be used for connection to the Configuration port.



9-pin D	Connection	TRS Plug
Pin 2	Computer's RX line	Tip
Pin 3	Computer's TX line	Ring
Pin 5	Computer's signal ground	Sleeve

**Figure 4-2 — Optional 9-pin TRS RS-232 cable**

**NOTE** This port is independent of the rear panel Remote port and is **not** affected by changes to the rear panel port's protocol. This front panel port's protocol can be changed, under SIS command control only. See the Command/Response table for IP SIS commands, later in this chapter, to configure both ports under SIS control.

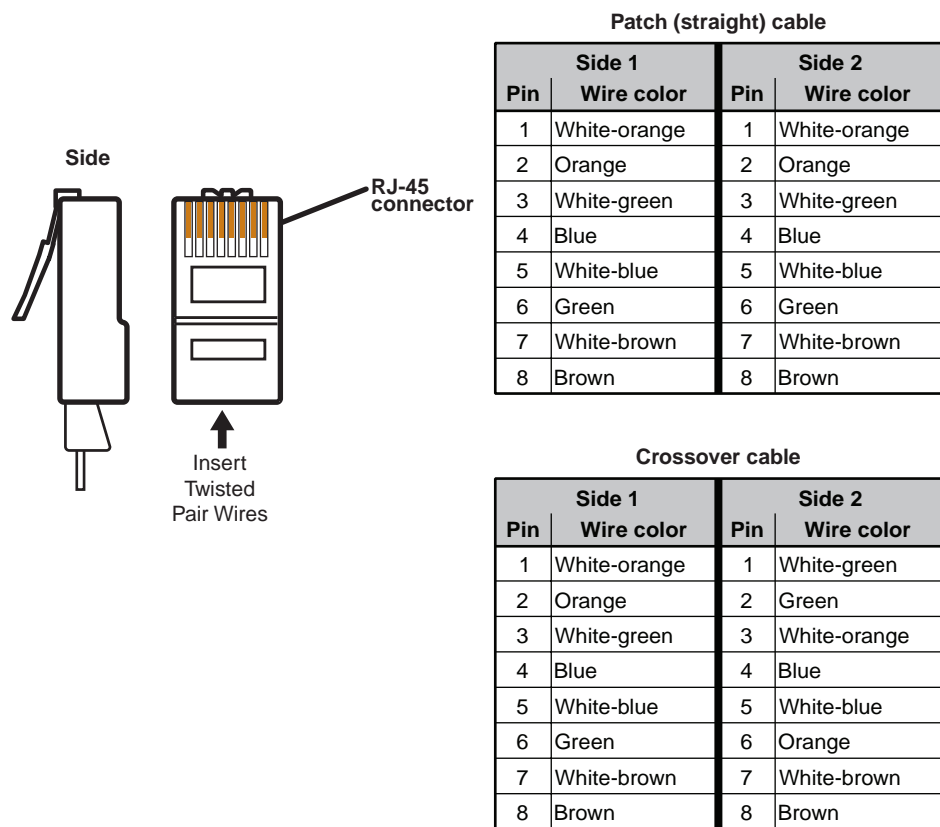
## Ethernet Link

The rear panel Ethernet connector on the switcher can be connected to an Ethernet LAN or WAN. This connection makes SIS control of the switcher possible using a computer connected to the same LAN or WAN.

### Ethernet connection

The Ethernet cable can be terminated as a straight-through cable or a crossover cable and must be properly terminated for your application (figure 4-2).

- **Crossover cable** — Direct connection between the computer and the CrossPoint 450 Plus or MAV Plus switcher.
- **Patch (straight) cable** — Connection of the CrossPoint 450 Plus or MAV Plus switcher to an Ethernet LAN.



**Figure 4-2 — RJ-45 Ethernet connector pin assignments**

### Default IP addresses

To access the CrossPoint 450 Plus or MAV Plus switcher via the Ethernet port, you will need the Extron IP address, and may need the subnet mask and the gateway address. If the IP address has been changed to an address comprised of words and characters, the actual numeric IP address can be determined using the ping (ICMP) utility (see appendix A, "Ethernet Connection", for more details). If the addresses have not been changed, the factory-specified defaults are:

- IP address            192.168.254.254            • Subnet mask        255.255.0.0
- Gateway address    0.0.0.0

---

## Host-to-Switcher Instructions

The switcher accepts SIS (Simple Instruction Set) commands through the serial ports and Ethernet port. SIS commands consist of one or more characters per command field. They do not require any special characters to begin or end the command character sequence. Each switcher response to an SIS command ends with a carriage return and a line feed (CR/LF = ↵), which signals the end of the response character string. A string is one or more characters.

## Switcher-Initiated Messages

When a local event such as a front panel operation occurs, the switcher responds by sending a message to the host. The switcher-initiated messages are listed below (underlined).

(c) Copyright 2007, Extron Electronics CP 300 450 MAV IP, Vx.xx, 60-*nnn-nn*{*day, date, time*}↵

The switcher initiates the copyright message when it is first powered on or when connection via Internet protocol (IP) is established. Vx.xx is the firmware version number and 60-*nnn-nn* is the switcher part number.

**NOTE** {*Day, date, time*} are only reported if the connection is via the LAN port.

↵ Password:

The switcher initiates the password message immediately after the copyright message when the controlling system is connected using TCP/IP or Telnet and the switcher is password protected. This message means that the switcher requires an administrator or user level password before it will perform the commands entered via this link. The switcher repeats the password message response for every entry other than a valid password until a valid password is entered.

↵ Login Administrator ↵

↵ Login User ↵

The switcher initiates the login message when a correct administrator or user password has been entered. If the user and administrator passwords are the same, the switcher defaults to administrator privileges.

Qik↵

The switcher initiates the Qik message when a front panel switching operation has occurred.

Spr*nn*↵

The switcher initiates the Spr message when a memory preset has been saved from the front panel. “*nn*” is the preset number.

Rpr*nn*↵

The switcher initiates the Rpr message when a memory preset has been recalled from the front panel. “*nn*” is the preset number.

In*nn* Aud*xx*↵

The switcher initiates the Aud message when a front panel input audio level change has occurred. “*nn*” is the input number and “*xx*” is the dB level.

Out*nn* Vol*xx*↵

The switcher initiates the Vol message when a front panel output audio volume change has occurred. “*nn*” is the output number and “*xx*” is the volume level.

## Programmer's Guide, cont'd

### Vmtnn•x↵

The switcher initiates the Vmt message when a video output mute is toggled on or off from the front panel. "nn" is the output number, • is a space, and "x" is the mute status: 1 = on, 0 = off.

### Amtnn•x↵

The switcher initiates the Amt message when an audio output mute is toggled on or off from the front panel. "nn" is the output number, • is a space, and "x" is the mute status: 1 = on, 0 = off.

### Exen↵

The switcher initiates the Exe message when executive mode is toggled on or off from the front panel. "n" is the executive mode status: 1 = on, 0 = off.

## Switcher Error Responses

When the switcher receives an SIS command and determines that it is valid, it performs the command and sends a response to the host device. If the switcher is unable to perform the command because the command is invalid or contains invalid parameters, the switcher returns an error response to the host. The error response codes are:

- E01 — Invalid input channel number (too large)
- E10 — Invalid command
- E11 — Invalid preset number
- E12 — Invalid output number (too large)
- E13 — Invalid value (out of range)
- E14 — Illegal command for this configuration
- E17 — Timeout (caused only by direct write of global presets)
- E21 — Invalid room number
- E24 — Privilege violation (Ethernet, Extron software only)

## Using the Command/Response Tables

The command/response tables begin on page 4-7. Lower case letters are acceptable in the command field except where indicated for the gain and attenuation commands. The table below shows the hexadecimal equivalent of each ASCII character used in the command/response table.

ASCII to HEX Conversion Table							Esc 1B	CR 0D	LF 0A
Space 20	! 21	" 22	# 23	\$ 24	% 25	& 26	' 27		
( 28	) 29	* 2A	+ 2B	, 2C	- 2D	. 2E	/ 2F		
0 30	1 31	2 32	3 33	4 34	5 35	6 36	7 37		
8 38	9 39	: 3A	; 3B	< 3C	= 3D	> 3E	? 3F		
@ 40	A 41	B 42	C 43	D 44	E 45	F 46	G 47		
H 48	I 49	J 4A	K 4B	L 4C	M 4D	N 4E	O 4F		
P 50	Q 51	R 52	S 53	T 54	U 55	V 56	W 57		
X 58	Y 59	Z 5A	[ 5B	\ 5C	] 5D	^ 5E	_ 5F		
` 60	a 61	b 62	c 63	d 64	e 65	f 66	g 67		
h 68	i 69	j 6A	k 6B	l 6C	m 6D	n 6E	o 6F		
p 70	q 71	r 72	s 73	t 74	u 75	v 76	w 77		
x 78	y 79	z 7A	{ 7B	7C	} 7D	~ 7E	DEL 7F		

Symbols are used throughout the table to represent variables in the command/response fields. Command and response examples are shown throughout the table.

## Command/Response Table for SIS Commands

### Symbol Definitions:

- ↵ = Carriage return/line feed
- ← = Carriage return (no line feed)
- = Space
- Esc = Escape key

**NOTE** *Input and output numbers in commands may be entered as either 1-digit, 2-digit, or 3-digit numbers. All input and output numbers are reported as 2-digit numbers in the response.*

- X1 = Input number 01 – (maximum number of inputs for your model)
- X2 = Input number (for tie) 00 – (maximum number of inputs) (00 = untied)
- X3 = Output number 01 – (maximum number of outputs for your model)
- X4 = Numeric dB value –18 to +24 (45 steps of gain or attenuation)
- X5 = Audio gain 0 – 24 (1 dB/step)
- X6 = Audio attenuation 1 – 18 (1 dB/step)
- X7 = Volume adjustment range 0 – 64 (1 dB/step except for 0-to-1, which is 13 dB)
- X8 = Room # (for room presets) 10 max. (each can have up to 10 presets (X2s) assigned)

**NOTE** *A **Room** is a subset of operator-selected outputs that relate to each other. The CrossPoint 450 Plus or MAV Plus switcher supports up to 10 **rooms**, each of which can consist of from 1 to 16 outputs.*

- X9 = Mute, Lock mode, power supply (0 = off/mode 0/not Ok, 1 = on/mode 1/Ok, 2 = mode 2)
- X10 = Group # (for I/O grouping) 1 through 4 groups (0 = no group)
- X11 = Global preset # 0, 01-32 maximum (0 = current configuration)
- X12 = Room preset # 10 maximum (0 = current configuration for room)

**NOTE** *A **Room preset** is a stored configuration with all of the outputs assigned to a single **room**. When a **room preset** is retrieved from memory, it becomes the current configuration.*

- X13 = RGB delay interval Delay in ½ second increments (10 maximum)
- X14 = Video/audio mute: 0 = no mutes  
1 = video mute  
2 = audio mute  
3 = video and audio mute
- X15 = Sync frequency xxx.xx (frequency in Hz (V) or kHz (H))
- X16 = Connection status 0 = no input connected  
1 = input connected

- X17 = Firmware version number to second decimal place (x.xx)
- X18 = Verbose firmware version-description-upload date/time. See page 4-16.
- X19 = Name 12 characters maximum for input, output, global preset, and room preset names.  
11 characters maximum for room names.  
Upper- and lower-case alphanumeric characters and \_ / and spaces are valid.

**NOTE** *The following characters are invalid in the name: {space} ~ , @ = ' [ ] { } < > ' " ; : | \ and ?.*

- X20 = Voltage Positive or negative voltage and magnitude
- X21 = Temperature Degrees Fahrenheit
- X22 = Fan speed RPM

# Programmer's Guide, cont'd

## Command/response table for SIS commands

Command	ASCII Command (host to switcher)	Response (switcher to host)	Additional description
<b>Create ties</b>			
<p><b>NOTE</b></p> <ul style="list-style-type: none"> <li>• Commands can be made back-to-back in a string, with no spaces. For example: 1*1!02*02&amp;003*003%4*24\$.</li> <li>• The quick multiple tie and tie input to all output commands activate all I/O switches simultaneously.</li> <li>• The CrossPoint 450 Plus and MAV Plus support 1-, 2-, and 3-digit numeric entries (1*1, 02*02, or 001*001).</li> </ul>			
Tie input $\boxed{x2}$ to output $\boxed{x3}$ , video (V) and audio (A)	$\boxed{x2}*\boxed{x3}!$ Example: 1*3!	Out $\boxed{x3}$ •In $\boxed{x2}$ •All↵ Out03•In01•All↵	Tie input $\boxed{x2}$ 's video and audio to output $\boxed{x3}$ . Tie input 1 V & A to output 3.
Tie input $\boxed{x2}$ to output $\boxed{x3}$ , RGBHV only	$\boxed{x2}*\boxed{x3}\&$ Example (see Note): 10*4&	Out $\boxed{x3}$ •In $\boxed{x2}$ •RGB↵ Out04•In10•RGB↵	Audio breakaway. Tie input 10 RGB to output 4.
Tie input $\boxed{x2}$ to output $\boxed{x3}$ , video only	$\boxed{x2}*\boxed{x3}\%$ Example (see Note): 7*5%	Out $\boxed{x3}$ •In $\boxed{x2}$ •Vid↵ Out05•In07•Vid↵	Audio breakaway. Tie input 7 video to output 5.
<p><b>NOTE</b> The &amp; tie command for RGB and the % tie command for video can be used interchangeably on the CrossPoint 450 Plus and MAV Plus switchers.</p>			
Tie input $\boxed{x2}$ to output $\boxed{x3}$ , audio only	$\boxed{x2}*\boxed{x3}\$$ Example: 12*24\$	Out $\boxed{x3}$ •In $\boxed{x2}$ •Aud↵ Out24•In12•Aud↵	Audio breakaway. Tie input 12 audio to output 24.
Quick multiple tie	$\text{Esc}+Q\boxed{x2}*\boxed{x3}!\dots\boxed{x2}*\boxed{x3}!\leftarrow$ Example: $\text{Esc}+Q3*4!3*5%3*6\$ \leftarrow$	Qik↵ Qik↵	Tie input 3 video and audio to output 4, tie input 3 video to output 5, and tie input 3 audio to output 6.
Tie input to all outputs, V & A	$\boxed{x2}!*1$ Example: 5*1!	In $\boxed{x2}$ •All↵ In05•All↵	Tie input 5 video and audio to all outputs.
Tie input to all outputs, RGBHV only	$\boxed{x2}*\&$ Example (see Note): 28*&	In $\boxed{x2}$ •RGB↵ In28•RGB↵	Tie input 28 RGB to all outputs.
Tie input to all outputs, video only	$\boxed{x2}*\%$ Example (see Note): 14*%	In $\boxed{x2}$ •Vid↵ In14•Vid↵	Tie input 14 video to all outputs.
<p><b>NOTE</b> The &amp; tie all command for RGB and the % tie all command for video can be used interchangeably on the CrossPoint 450 Plus and MAV Plus switchers.</p>			
Tie input to all outputs, audio only	$\boxed{x2}*\$$ Example: 1*\$	In $\boxed{x2}$ •Aud↵ In01•Aud↵	Tie input 1 audio to all outputs.
<b>Read ties</b>			
Read RGBHV output tie	$\boxed{x3}\&$	$\boxed{x2}\leftarrow$	RGBHV input $\boxed{x2}$ tied to output $\boxed{x3}$ .
Read video output tie	$\boxed{x3}\%$	$\boxed{x2}\leftarrow$	Video input $\boxed{x2}$ tied to output $\boxed{x3}$ .
<p><b>NOTE</b> The &amp; read tie command for RGB and the % read tie command for video can be used interchangeably on the CrossPoint 450 Plus and MAV Plus switchers.</p>			
Read audio output tie	$\boxed{x3}\$$	$\boxed{x2}\leftarrow$	Audio input $\boxed{x2}$ tied to output $\boxed{x3}$ .
<b>Digital Sync Validation Processing (DSVP)</b>			
List individual sync frequency	$\boxed{x1}\text{LS}$ Example: 2LS	$\boxed{x15}, \boxed{x15}\leftarrow$ 031.50,060.00↵	Listed as H freq., V freq. Input 2 frequency is 31.5 kHz horizontal and 60 Hz vertical.
<p><b>NOTE</b> The matrix switcher returns 000.00,000.00 if there is no connection or sync frequencies are not applicable.</p>			

## Command/response table for SIS commands (Cont'd)

Command	ASCII Command (host to switcher)	Response (switcher to host)	Additional description
View connections (CrossPoint 450 Plus only)	0LS	$\boxed{x16}^1 \boxed{x16}^2 \dots \boxed{x2}^n \leftarrow$	Each $\boxed{x16}$ response is the connection status of an input, starting from input 1, $n$ is the maximum number of inputs for this model.
<b>Video mute commands</b>			
RGB/video mute	$\boxed{x3}^*1B$	Vmt $\boxed{x3}^*1 \leftarrow$	Mute output $\boxed{x3}$ RGB (video off).
RGB/video unmute	$\boxed{x3}^*0B$	Vmt $\boxed{x3}^*0 \leftarrow$	Unmute output $\boxed{x3}$ RGB (video on).
Read RGB/video mute	$\boxed{x3}B$	$\boxed{x9} \leftarrow$	1= mute on, 0 = mute off.
Global RGB/video mute	1*B	Vmt1 $\leftarrow$	Mute all RGB outputs.
Global RGB/video unmute	0*B	Vmt0 $\leftarrow$	Unmute all RGB outputs.
<b>RGB delay</b>			
Set RGB delay <i>Example:</i>	$\boxed{Esc}\boxed{x3}^*\boxed{x13}D \leftarrow$ $\boxed{Esc}13^*7D \leftarrow$	Out $\boxed{x3}$ •Dly $\boxed{x13} \leftarrow$ Out13•Dly07 $\leftarrow$	Sets the RGB interval for switches to output 13 to 3.5 sec. (7 x 0.5 sec).
Read RGB delay <i>Example:</i>	$\boxed{Esc}\boxed{x3}D \leftarrow$ $\boxed{Esc}14D \leftarrow$	$\boxed{x13} \leftarrow$ 05 $\leftarrow$	Output 14 interval is 2.5 sec. (5 x 0.5 sec).
<b>Audio input gain and attenuation</b>			
<b>NOTE</b> The set gain (G) and attenuation (g) commands are case sensitive.			
Set input audio gain to + dB value <i>Example:</i>	$\boxed{x1}^*\boxed{x5}G$ 1*2G	In $\boxed{x1}$ •Aud $\boxed{x4} \leftarrow$ In01•Aud+02 $\leftarrow$	Set input 1 audio gain to +2 dB.
Set input audio attenuation to - dB value	$\boxed{x1}^*\boxed{x6}g$	In $\boxed{x1}$ •Aud $\boxed{x4} \leftarrow$	
Increment gain <i>Example:</i>	$\boxed{x1}+G$ 5+G	In $\boxed{x1}$ •Aud $\boxed{x4} \leftarrow$ In05•Aud+03 $\leftarrow$	Increase gain by 1 dB. Audio input 5 level incremented from +2 dB to +3 dB.
Decrement gain <i>Example:</i>	$\boxed{x1}-G$ 7-G	In $\boxed{x1}$ •Aud $\boxed{x4} \leftarrow$ In07•Aud-09 $\leftarrow$	Decrease gain by 1 dB. Audio input 7 level decremented from -8 dB to -9 dB.
Read input gain	$\boxed{x1}G$	$\boxed{x4} \leftarrow$	
<b>Audio output volume</b>			
<b>NOTE</b> The table on page 4-10 defines the value of each audio volume step.			
Set audio volume to specific value <i>Example:</i>	$\boxed{x3}^*\boxed{x7}V$ 1*50v	Out $\boxed{x3}$ •Vol $\boxed{x7} \leftarrow$ Out01•Vol50 $\leftarrow$	Set output 1 volume to 79%.
Increment volume <i>Example:</i>	$\boxed{x3}+V$ 1+V	Out $\boxed{x3}$ •Vol $\boxed{x7} \leftarrow$ Out01•Vol51 $\leftarrow$	Increase volume by 1 step. Audio output 1 level incremented from 79% to 80.5%.
Decrement volume	$\boxed{x3}-V$	Out $\boxed{x3}$ •Vol $\boxed{x7} \leftarrow$	Decrease volume by 1 step.
Read output volume	$\boxed{x3}V$	$\boxed{x7} \leftarrow$	
<b>Audio mute commands</b>			
Audio mute	$\boxed{x3}^*1Z$	Amt $\boxed{x3}^*1 \leftarrow$	Mute output $\boxed{x3}$ audio (audio off).
Audio unmute	$\boxed{x3}^*0Z$	Amt $\boxed{x3}^*0 \leftarrow$	Unmute output $\boxed{x3}$ audio (audio on).
Read audio mute	$\boxed{x3}Z$	$\boxed{x9} \leftarrow$	1= mute on, 0 = mute off.
Global audio mute	1*Z	Amt1 $\leftarrow$	
Global audio unmute	0*Z	Amt0 $\leftarrow$	



## Programmer's Guide, cont'd

### Audio volume adjustment settings

X7 value	dB of attenuation	Output volume	X7 value	dB of attenuation	Output volume	X7 value	dB of attenuation	Output volume
00	76	0%						
01	63	5.5%	23	41	38.5%	45	19	71.5%
02	62	7%	24	40	40%	46	18	73%
03	61	8.5%	25	39	41.5%	47	17	74.5%
04	60	10%	26	38	43%	48	16	76%
05	59	11.5%	27	37	44.5%	49	15	77.5%
06	58	13%	28	36	46%	50	14	79%
07	57	14.5%	29	35	47.5%	51	13	80.5%
08	56	16%	30	34	49%	52	12	82%
09	55	17.5%	31	33	50.5%	53	11	83.5%
10	54	19%	32	32	52%	54	10	85%
11	53	20.5%	33	31	53.5%	55	9	86.5%
12	52	22%	34	30	55%	56	8	88%
13	51	23.5%	35	29	56.5%	57	7	89.5%
14	50	25%	36	28	58%	58	6	91%
15	49	26.5%	37	27	59.5%	59	5	92.5%
16	48	28%	38	26	61%	60	4	94%
17	47	29.5%	39	25	62.5%	61	3	95.5%
18	46	31%	40	24	64%	62	2	97%
19	45	32.5%	41	23	65.5%	63	1	98.5%
20	44	34%	42	22	67%	64	0	100%
21	43	35.5%	43	21	68.5%			
22	42	37%	44	20	70%			

## Command/response table for SIS commands (Cont'd)

Command	ASCII Command (host to switcher)	Response (switcher to host)	Additional description
<b>Names</b>			
Write global preset name <i>Example:</i>	<code>Esc[X11,X19]NG ←</code> <code>Esc1,Security 1NG ←</code>	<code>Nmg[X11,X19] ↵</code> <code>Nmg01,Security 1 ↵</code>	Name global preset 1 "Security 1".
Read global preset name <i>Example:</i>	<code>Esc[X11]NG ←</code> <code>Esc2NG ←</code>	<code>[X19] ↵</code> <code>Security 2 ↵</code>	
Write room name <i>Example:</i>	<code>Esc[X8,X19]NR ←</code> <code>Esc1,Classrm 1NR ←</code>	<code>Nmr[X8,X19] ↵</code> <code>Nmr01,Classrm 1 ↵</code>	Name room "Classrm 1".
Read room name	<code>Esc[X8]NR ←</code>	<code>[X19] ↵</code>	
Write room preset name <i>Example:</i>	<code>Esc[X8]*[X12,X19]NP ←</code> <code>Esc1*3,Podium_DVDNP ←</code>	<code>Nmp[X8]*[X12,X19] ↵</code> <code>Nmp01*03,[X19] ↵</code>	Name room 1, preset 3 "Podium_DVD".
Read room preset name	<code>Esc[X8]*[X12]NP ←</code>	<code>[X19] ↵</code>	
<b>NOTE</b>	<ul style="list-style-type: none"> <li>• If a preset is unassigned, then [X19] displays [unassigned].</li> <li>• If a global preset is saved, but not yet named, the default name is Preset [X11].</li> <li>• If a room preset is saved, but not yet named, the default name is Rm[X8] Prst[X12].</li> </ul>		
Write input name <i>Example:</i>	<code>Esc[X1,X19]NI ←</code> <code>Esc1,Podium camNI ←</code>	<code>Nmi[X1,X19] ↵</code> <code>Nmi01,Podium cam ↵</code>	Name input 1 "Podium cam".
Read input name	<code>Esc[X1]NI ←</code>	<code>[X19] ↵</code>	
Write output name <i>Example:</i>	<code>Esc[X1,X19]NO ←</code> <code>Esc1,Main PJ1NO ←</code>	<code>Nmo[X1,X19] ↵</code> <code>Nmo01,Main PJ1 ↵</code>	Name output 1 "Main PJ1".
Read output name	<code>Esc[X1]NO ←</code>	<code>[X19] ↵</code>	
<b>I/O Grouping</b>			
Write input grouping	<code>Esc[X10]<sup>1</sup>[X10]<sup>2</sup>...[X10]<sup>n</sup> ←</code>	<code>Gri ↵ [X10]<sup>1</sup>[X10]<sup>2</sup>[X10]<sup>3</sup>...[X10]<sup>n</sup> ↵</code>	Each [X10] entry is the group number assigned to an input position, starting from input 1, <i>n</i> is the maximum number of inputs for this model.
<i>Example for CrossPoint 450 Plus 3232:</i>	<code>Esc140...33I ←</code>	See below	
	Input 1 in group 4    Input 2 not grouped		Input 32 in group 3
	Response #s = group: Gri 4 0 1 3 3 0 0 0 0 4 4 4 4 1 1 2 2 1 2 2 3 3 3 3 2 1 2 2 3 3 3 3		Input 1 - Group 4, Input 2 - Group 0 (not grouped),...Input 31 - Group 3, Input 32 - Group 3.
	Input: 01 02 03 04 05 06 07 08 09 10 11 12 13 14 15 16 17 18 19 20 21 22 23 24 25 26 27 28 29 30 31 32		
Write output grouping	<code>Esc[X10]<sup>1</sup>[X10]<sup>2</sup>...[X10]<sup>n</sup>O ←</code>	<code>Gro[X10]<sup>1</sup>[X10]<sup>2</sup>...[X10]<sup>n</sup> ↵</code>	Each [X10] entry is the group number assigned to an output position, starting from output 1, <i>n</i> is the maximum number of outputs for this model.
Read input grouping	<code>EscI ←</code>	<code>[X10]<sup>1</sup>[X10]<sup>2</sup>[X10]<sup>3</sup>...[X10]<sup>n</sup> ↵</code>	One [X10] entry for each input, starting from input 1, <i>n</i> is the maximum number of inputs for this model.
<i>Example for CrossPoint 450 Plus 2424:</i>	<code>EscI ←</code>	See below	
	Input 1 in group 1    Input 9 not grouped    Input 24 in group 3		
	Response = group: 1 1 1 3 3 0 0 0 0 4 4 4 4 1 1 2 2 1 2 2 3 3 3 3		
	Input: 01 02 03 04 05 06 07 08 09 10 11 12 13 14 15 16 17 18 19 20 21 22 23 24		

# Programmer's Guide, cont'd

## Command/response table for SIS commands (Cont'd)

Command	ASCII Command (host to switcher)	Response (switcher to host)	Additional description
<b>I/O Grouping (Continued)</b>			
Read output grouping	<code>[Esc]O ←</code>	<code>[X10]<sup>1</sup> [X10]<sup>2</sup> [X10]<sup>3</sup> ... [X10]<sup>n</sup> ↵</code>	One <code>[X10]</code> entry for each output, starting from input 1, <i>n</i> is the maximum number of inputs for this model.
<p><b>NOTE</b> <i>The group that is assigned (<code>[X10]</code>) must be 1, 2, 3, 4, or 0 (not grouped).</i></p>			
<b>Save, recall, and directly write presets</b>			
<p><b>NOTE</b></p> <ul style="list-style-type: none"> <li>If the user tries to recall a preset that is not saved, the matrix switcher responds with the error code E11.</li> <li>If the room is nonexistent, the matrix switcher responds with the error code E21.</li> <li>The following characters are invalid in preset names: + ~ , @ = ' [ ] { } &lt; &gt; ' " ; :   \ and ?.</li> </ul>			
Save current ties as a global preset	<code>[X11],</code>	<code>Spr[X11] ↵</code>	Command character is a comma.
Example:	<code>9,</code>	<code>Spr09 ↵</code>	Save current ties as preset 9.
Recall a global preset	<code>[X11].</code>	<code>Rpr[X11] ↵</code>	Command character is a period.
Example:	<code>5.</code>	<code>Rpr05 ↵</code>	Recall preset 5, which becomes the current configuration.
Save current ties for a room	<code>[X8]*[X12],</code>	<code>Rmm[X8]*Spr[X12] ↵</code>	Command character is a comma.
Example:	<code>3*9,</code>	<code>Rmm03*Spr09 ↵</code>	Save current ties as preset 9 for room 3.
<b>Direct write process —</b>			
<p><b>NOTE</b> <i>The direct write of a global preset should always be preceded by a clear global preset command of that same preset number, as shown below. In a directly-written preset, each output position's tied input (or no tied input) remains unchanged unless overwritten or cleared.</i></p> <p><i>If you do not clear a global preset number before you directly write a global preset to that number, ties that are part of the previous version of the specified presets with the same number can unexpectedly become part of the newly-created preset.</i></p>			
Clear a global preset	<code>[Esc]+[X11]P0*! ←</code>	<code>Spr[X11] ↵</code>	Clear all ties in preset number <code>[X11]</code>
Directly write a global preset	<code>[Esc]+[X11]P[X2]*[X3]![X2]*[X3]![X2]*[X3]!\$...[X2]*[X3]&amp; ←</code>	<code>Spr[X11] ↵</code>	The tie all (!), tie RGBHV (&), tie video (%), and tie audio (\$) commands are all valid.
Example:	<code>[Esc]+27P2*5!10*9\$13*11%3*10&amp; ←</code>	<code>Spr27 ↵</code>	<u>Brackets are shown to separate ties for clarity only.</u> Create global preset 27, which ties video and audio input 22 to output 5, RGBHV input 15 to output 29, video input 13 to output 26, and audio input 3 to output 8.
Write room outputs	<code>[Esc][X8],[Y1],[Y2],...[Yn]MR ←</code>	<code>Mpr[X8],[Y1],[Y2],...[Yn] ↵</code>	See notes.
<p><b>NOTE</b></p> <ul style="list-style-type: none"> <li>Each <code>[Y#]</code> is an output</li> <li>A room can contain a maximum of 16 outputs.</li> <li>An output can only belong to one room.</li> <li>The maximum number of rooms (<code>[X8]</code>) is 10.</li> <li>If no room name is assigned, the default name is "Room <code>#[X8]•[Y1],[Y2],[Y3]</code>".</li> </ul>			
Example:	<code>[Esc]8,3,04,5,6MR ←</code>	<code>Mpr8,03,04,05,06 ↵</code>	Outputs 3, 4, 5, and 6 are assigned to room 8.

## Command/response table for SIS commands (Cont'd)

Command	ASCII Command (host to switcher)	Response (switcher to host)	Additional description
<b>Save, recall, and directly write presets (continued)</b>			
Read room outputs <i>Example:</i>	<code>Esc[X8]MR ←</code> <code>Esc3MR ←</code>	<code>[X19][Y1][Y2][Yn] ↓</code> Class 1,01,02,08,09 ↓	Outputs 1, 2, 8, and 9 are assigned to room 3, which is named "Class 1".
Recall a room preset	<code>[X8]*[X12].</code>	<code>Rmm[X8]*Rpr[X12] ↓</code>	Command character is a period.
Directly write a room preset  <i>Example:</i>	<code>Esc+[X8]*[X12]P[X2]*[X3]![X2]*[X3%][X2]*[X3]\$...[X2]*[X3]&amp; ←</code>  <code>Esc+7*3P12*7&amp;13*35\$4*26%6*6! ←</code>	<code>Rmm[X8]*Spr[X12] ↓</code>  Rmm07*Spr03 ↓	Enter as many ties as are valid for this model. Tie all (!), tie RGBHV (&), tie video (%), and tie audio (\$) commands are all valid.  Brackets are shown to separate ties for clarity only. Create preset 3 for room 7, which ties audio input 12 to output 7, video input 13 to output 35, RGBHV input 4 to output 26, and video and audio input 6 to output 6.
<b>Lock (executive) modes</b>			
<b>NOTE</b> See "Setting the front panel locks (Executive modes)" in chapter 3, "Operation" for more information on the Lock modes.			
Lock all front panel functions	1X	Exe1 ↓	Enable Lock mode 1.
Lock advanced front panel functions	2X	Exe2 ↓	Enable Lock mode 2.
Unlock all front panel functions	0X	Exe0 ↓	Enable Lock mode 0.
View Lock mode	X	[X9] ↓	
<b>Resets</b>			
Reset global presets and names	<code>EscZG ←</code>	Zpg ↓	Clear all global presets and their names.
Reset an individual global preset	<code>Esc[X11]ZG ←</code>	Zpg[X11] ↓	Clear global preset [X11].
Reset RGB delays	<code>EscZD ←</code>	Zpd ↓	Reset all RGB delays to 0.0 seconds.
Reset audio input levels	<code>EscZA ←</code>	Zpa ↓	Reset all audio input levels (gain and attenuation) to 0 dB.
Reset audio output levels	<code>EscZV ←</code>	Zpv ↓	Reset all audio output levels (volume) to 100% (no attenuation).
Reset all mutes	<code>EscZZ ←</code>	Zpz ↓	Reset all video and audio mutes.
Reset room map	<code>EscZR ←</code>	Zpr ↓	Clear all room presets.
Reset individual room	<code>Esc[X8]ZR ←</code>	Zpr[X8] ↓	Clear all presets for room [X8].
Reset individual room preset	<code>Esc[X8]*[X12]ZP ←</code>	Zpp[X8]*[X12] ↓	Clear individual room preset and name.
Reset flash	<code>EscZFFF ←</code>	Zpf ↓	Reset flash memory (erase user-supplied files).
Reset whole switcher	<code>EscZXXX ←</code>	Zpx ↓	Clears all ties and presets, resets all audio gains to 0 dB, and resets volume to 100%.
Absolute reset	<code>EscZQQQ ←</code>	Zpq ↓	Similar to <b>Reset whole switcher</b> , plus clears IP address to 192.168.254.254 and subnet mask to 255.255.0.0.

# Programmer's Guide, cont'd

## Command/response table for SIS commands (Cont'd)

Command	ASCII Command (host to switcher)	Response (switcher to host)	Additional description
<b>View ties, gain, volume, mutes, presets, and DSVP</b>			
View RGBHV output tie <i>Example:</i>	<code>[X3]&amp;</code> 15&	<code>[X2]↵</code> 27↵	Input 27 RGBHV tied to output 15.
View video output tie <i>Example:</i>	<code>[X3]%</code> 7%	<code>[X2]↵</code> 02↵	Input 2 video tied to output 7.
View audio output tie <i>Example:</i>	<code>[X3]\$</code> 3\$	<code>[X2]↵</code> 06↵	Input 6 audio tied to output 3.
View input gain <i>Example:</i>	<code>[X2]G</code> 4G	<code>[X4]↵</code> -02↵	Gain for input #4 is -2 dB.
View output volume <i>Example:</i>	<code>[X2]V</code> 7V	<code>[X7]↵</code> 55↵	Volume for output #7 is 55 steps (9 dB of attenuation / 86.5% of total volume).
View output mutes  <i>Example:</i> (CrossPoint 450 Plus 3232 HVA)	<code>[Esc]VM←</code>  <code>[Esc]VM←</code>	Mut <code>[X14]<sup>1</sup>[X14]<sup>2</sup>...[X14]<sup>n</sup>↵</code>  Mut000010000002300000000000000000↵	Each <code>[X14]</code> response is the mute status of an output, starting from output 1, <i>n</i> is the maximum number of outputs for this model.  Output 5 video is muted, output 12 audio is muted, and output 13 video and audio are muted. All other outputs are unmuted.
<b>NOTE</b> The MUT portion of the response appears only when the switcher is in Verbose mode 3. See the Verbose mode command on page 4-19.			
View video global preset configuration  <i>Command description:</i> <i>Response description:</i> <i>Example:</i>	<code>[Esc][X11]*[X3]*1VC←</code>	<code>[X2]<sup>1</sup>•[X2]<sup>2</sup>•[X2]<sup>3</sup>•...•[X2]<sup>16</sup>•Vid↵</code>  preset#*starting output# (StO#)*I(=video)VC input # (I#) assigned to StO#•I# assigned to StO#+1...I# assigned to StO#+15•Vid↵  <code>[Esc]4*17*1VC←</code> input 24 tied to output 19 no tied input input 8 tied to output 29 Response = tied input: <code>08•08•24•08•08•29•29•00•08•01•01•01•08•08•08•08•Vid↵</code> Output: 17 18 19 20 21 22 23 24 25 26 27 28 29 30 31 32	Show preset <code>[X11]</code> 's video configuration. Show the video input tied to 16 sequential outputs, starting from output <code>[X3]</code> .
<b>NOTE</b> The starting output # (StO#) should always be 1 for matrix sizes of 16 outputs or smaller.			
<b>NOTE</b> <code>[Esc][X11]*[X3]*1VC←</code> where <code>[X11] = 0</code> returns the switcher's current video configuration.			
Each position shown in the response is an output: left = starting, right= starting output +15. The number in each position is the input tied to that output. Video — Input 1 is tied to outputs 26 through 28; input 8 to outputs 17, 18, 20,21, 25, and 29 through 32; input 24 to output 19; and input 29 to outputs 22 and 23. No input is tied to output 24.			

## Command/response table for SIS commands (Cont'd)

Command	ASCII Command (host to switcher)	Response (switcher to host)	Additional description
<b>View ties, gain, volume, mutes, presets, and DSVP (continued)</b>			
View audio global preset configuration	<code>Esc[x11]*[x3]*2VC←</code>	<code>[x2]<sup>1</sup>•[x2]<sup>2</sup>•[x2]<sup>3</sup>•...•[x2]<sup>16</sup>•Aud↵</code>	Show preset <code>[x11]</code> 's audio configuration. Show the audio input tied to 16 sequential outputs, starting from output <code>[x3]</code> .
<i>Command description:</i>		preset#*starting output# (StO#)*2(=audio)VC	
<i>Response description:</i>		input # (I#) assigned to StO#•I# assigned to StO#+1...I# assigned to StO#+15•Aud↵	
<i>Example (CrossPoint 450 Plus 2412):</i>	<code>Esc0*1*2VC←</code>	input 1 tied to output 3    no tied input    no outputs Response = tied input: <code>01•01•01•01•02•22•22•00•03•03•03•03•...•Aud↵</code> Output: 01 02 03 04 05 06 07 08 09 10 11 12 13 14 15 16	
<b>NOTE</b>	<i>The starting output # (StO#) should always be 1 for matrix sizes of 16 outputs or smaller.</i>		
<b>NOTE</b>	<code>Esc[x11]*[x3]*2VC←</code> where <code>[x11]=0</code> returns the switcher's current audio configuration.		
Audio — Input 1 is tied to outputs 1 through 4, input 2 is tied to output 5, input 3 is tied to outputs 9 through 12, and input 22 is tied to outputs 6 and 7. No input is tied to output 8. The switcher in this example is a CrossPoint 450 Plus 2412, so outputs 13 through 16 are not present.			
View video room preset configuration	<code>Esc[x8]*[x12]*1*1VC←</code>	<code>[x2]•[x2]<sup>1</sup>•[x2]<sup>2</sup>•...•[x2]<sup>15</sup>•Vid↵</code>	Show room <code>[x8]</code> , preset <code>[x11]</code> 's video configuration. Show the video input tied to up to 16 outputs, assigned to room <code>[x8]</code> .
<i>Command description:</i>		room#* room preset#*starting output# (StO#) (always 1)*1(=video)VC	
<i>Response description:</i>		input # (I#) assigned to StO#•I# assigned to StO#+1...I# assigned to StO#+15•Vid↵	
<b>NOTE</b>	<i>The starting output # (StO#) should always be 1 for matrix sizes of 16 outputs or smaller.</i>		
View audio room preset configuration	<code>Esc[x8]*[x12]*1*2VC←</code>	<code>[x2]•[x2]<sup>1</sup>•...•[x2]<sup>15</sup>•Aud↵</code>	Show room <code>[x8]</code> , preset <code>[x11]</code> 's audio configuration. Show the audio input tied to up to 16 outputs, assigned to room <code>[x8]</code> .
<i>Command description:</i>		room#* room preset#*starting output# (StO#) (always 1)*2(=audio)VC	
<i>Response description:</i>		input # (I#) assigned to StO#•I# assigned to StO#+1...I# assigned to StO#+15•Aud↵	
<b>NOTE</b>	<i>The starting output # (StO#) should always be 1 for matrix sizes of 16 outputs or smaller.</i>		
<b>NOTE</b>	<i>The response to the View File Directory command differs, depending on whether the command is sent via a serial port or Telnet connection or sent via a Web browser connection.</i>		
View file directory <u>serial port and Telnet</u>	<code>EscDF←</code>	<code>filename1,date/time,length↵</code> <code>filename2,date/time,length↵</code> <code>filename3,date/time,length↵</code> •           • •           • <code>filenamen,date/time,length↵</code> <code>space_remaining Bytes•Left↵↵</code>	List user-supplied files.
View file directory <u>Web browser</u>	<code>EscDF←</code>	Var file = new array (); File [1] = 'filename1,date1,filesize1'; File [2] = 'filename2,date2,filesize2'; File [3] = 'filename3,date3,filesize3'; •           • •           • File[n] = 'filenamen,daten,filesize'; File[n+1] = space_remaining Bytes•Left	List user-supplied files.
Erase user-supplied Web pages/files	<code>EscfilenameEF←</code>	<code>Delfilename↵</code>	



## Command/Response Table for IP SIS Commands

### Symbol Definitions:

<b>X30</b>	= Matrix name	(Up to 240 characters)
	<b>NOTE</b>	<i>The following characters are invalid in the name: {space} ~ , @ = , ' [ ] { } &lt; &gt; ' " ; :   \ and ?.</i>
<b>X31</b>	= Default name	Factory default name (model name + last 3 pairs of MAC address).
<b>X32</b>	= Time and date (set)	MM/DD/YY•HH:MM:SS <i>where:</i> MM = month: 01 (January) through 12 (December) DD = day: 01 through 31 YY = year: 00 through 99 HH = hour: 00 through 24 MM = minutes: 00 through 59 SS = seconds: 00 through 59
<b>X33</b>	= Time and date (read)	In the format: Day•DD•Mmm•YYYY•HH:MM:SS <i>where:</i> Day = weekday: Mon through Sun DD = day: 01 through 31 Mmm = month: Jan through Dec YYYY = year: 2000 through 2099 HH = hour: 00 through 24 MM = minutes: 00 through 59 SS = seconds: 00 through 59
<b>X34</b>	= GMT offset	-12.0 through +14.0. Hours and minutes removed from GMT
<b>X35</b>	= Daylight Savings Time	0 = Daylight Savings Time off/ignore 1 = Daylight Savings Time on (northern hemisphere) 2 = Daylight Savings Time on (Europe) 3 = Daylight Savings Time on (Brazil)
<b>X36</b>	= IP address	###.###.###.###
<b>X37</b>	= Hardware (MAC) address	##-##-##-##-##-##
<b>X38</b>	= Number of open connections	0 - 255
<b>X39</b>	= Password	12 digits, alphanumeric
	<b>NOTE</b>	<i>The following characters are invalid in passwords: {space} + ~ , @ = ' [ ] { } &lt; &gt; ' " ; :   \ and ?.</i>
<b>X40</b>	= Domain name	Standard domain name conventions apply (for example, xxx.com)
	<b>NOTE</b>	<i>The following characters are invalid in a domain name: {space} + ~ , = ' [ ] { } &lt; &gt; ' " ; :   \ and ?. The @ character is only acceptable as the lead-in to the domain name (such as @extron.com).</i>
<b>X41</b>	= E-mail account	65 - 72. 65 = e-mail recipient #1, 66 = 2, 67 = 3, ..., 72 = recipient #8
<b>X42</b>	= E-mail address	Typical e-mail address format (for example, nnnnn@xxx.com)
<b>X43</b>	= Notify when?	0 = No response, 1 = fail/missing, 2 = fixed/restored, 3 = both 1 & 2
<b>X44</b>	= Notification selections	Matrix size 2412 and larger: 01 - 32 = input 1 through input 32 98 = power supplies 99 = fans Matrix size 1616 and smaller: 01 - 16 = input 1 through input 16 17 = power supply
<b>X45</b>	= Notify status (for read)	34- or 17-digit number. For each digit: 0 = do not notify, 1 = notify
<b>X46</b>	= DHCP	(0 = off, 1 = on)
<b>X47</b>	= Port #	00 - 99 (00 = all ports)
<b>X48</b>	= Baud rate	9600, 19200, 38400, 115200
<b>X49</b>	= Parity	<u>O</u> dd, <u>e</u> ven, <u>n</u> one, <u>m</u> ark, <u>s</u> pace (only first letter required)



## Programmer's Guide, cont'd

<b>X50</b>	= Data bits	7, 8
<b>X51</b>	= Stop bits	1, 2
<b>X52</b>	= Port type	0 = RS-232, 1 = RS-422, 2 = RS-485
<b>X53</b>	= Verbose mode	0 = Clear/none (default for Telnet connection) 1 = Verbose mode (default for RS-232/RS-422 connection) 2 = Tagged responses for queries 3 = Verbose mode and tagged for queries

**NOTE** *If tagged responses is enabled, all read commands return the constant string and the value as the set command does (for example, the read matrix name command, `EscCN←`, returns `Ipn•X30←`).*

<b>X54</b>	= RAM status	0 = RAM dirty (needs saving to flash) 1 = RAM has been saved (ok to power off/reset)
------------	--------------	---

### Command/response table for IP SIS commands

Command	ASCII Command (host to switcher)	Response (switcher to host)	Additional description
<b>IP setup commands</b>			
Set matrix name (location)	<code>EscX30CN←</code>	<code>Ipn•X30←</code>	
Read matrix name (location)	<code>EscCN←</code>	<code>X30←</code>	
Reset matrix name to factory default	<code>Esc•CN←</code>	<code>Ipn•X31←</code>	
Set time and date	<code>EscX32CT←</code>	<code>IptX32←</code>	
Read time and date	<code>EscCT←</code>	<code>X33←</code>	
Set GMT offset	<code>EscX34CZ←</code>	<code>IpzX34←</code>	The divider between hours and minutes is a period.
Read GMT offset	<code>EscCZ←</code>	<code>X34←</code>	
Set Daylight Savings Time	<code>EscX35CX←</code>	<code>IpxX35←</code>	Set the switcher to display the local time as Daylight Savings Time (+1 hour) in summer months.
Read Daylight Savings Time	<code>EscCX←</code>	<code>X35←</code>	
Set IP address	<code>EscX36CI←</code>	<code>IpiX36←</code>	
Read IP address	<code>EscCI←</code>	<code>X36←</code>	
Read hardware address	<code>EscCH←</code>	<code>X37←</code>	
Read # of open connections	<code>EscCC←</code>	<code>IccX38←</code>	
Set subnet mask	<code>EscX36CS←</code>	<code>IpsX36←</code>	
Read subnet mask	<code>EscCS←</code>	<code>X36←</code>	
Set gateway IP address	<code>EscX36CG←</code>	<code>IpgX36←</code>	
Read gateway IP address	<code>EscCG←</code>	<code>X36←</code>	
Set administrator password	<code>EscX39CA←</code>	<code>Ipa•X39←</code>	
Read administrator password	<code>EscCA←</code>	<code>X39←</code>	
Reset (clear) administrator password	<code>Esc•CA←</code>	<code>Ipa•X30←</code>	
Set user password	<code>EscX39CU←</code>	<code>IpuX39←</code>	
Read user password	<code>EscCU←</code>	<code>X39←</code>	
Reset (clear) user password	<code>Esc•CU←</code>	<code>Ipu•X30←</code>	
Set mail server, domain name	<code>EscX36,X40,X39CM←</code>	<code>IpmX36,X40,X39←</code>	
Read mail server, domain name	<code>EscCM←</code>	<code>X36,X40,X39←</code>	
Set e-mail recipient	<code>EscX41,X42CR←</code>	<code>IprX42,←</code>	This command sets the recipient. To receive e-mail notifications, you must then set the events that the switcher reports using one or more separate <i>Set e-mail events (EM)</i> commands (see next page).
<i>Example</i>	<code>Esc72,JSmith@folklore.netCR←</code>	<code>Ipr•JSmith@folklore.net,←</code>	
Read e-mail recipient	<code>EscX41CR←</code>	<code>IprX42,X44,←</code>	



## Programmer's Guide, cont'd

---

*This page was intentionally left blank.*



# CrossPoint 450 Plus and MAV Plus Switchers

# 5 Chapter Five

## Matrix Software

Matrix Switchers Control Program

Special Characters

Button-Label Generator

# Matrix Software

## Matrix Switchers Control Program

The Windows-based Extron Matrix Switchers Control Program, which communicates with the switcher via the rear panel Remote RS-232/RS-422 port, the front panel Configuration (RS-232) port (matrix sizes up to 1616), and the LAN port, provides an easy way to set up ties and sets of ties. The program is compatible with Windows 2000 and Windows XP.

### Installing the software

The program is contained on the Extron Software Products CD-ROM, disk B. Install the software as follows:

**NOTE** For full functionality, install both of the following programs:

- The Matrix Switchers Control Program
- The Firmware Loader

1. Insert the CD-ROM into the drive. The installation program should start automatically. If it does not self-start, run Launch.exe from the CD.

The Extron software CD window appears (figure 5-1).

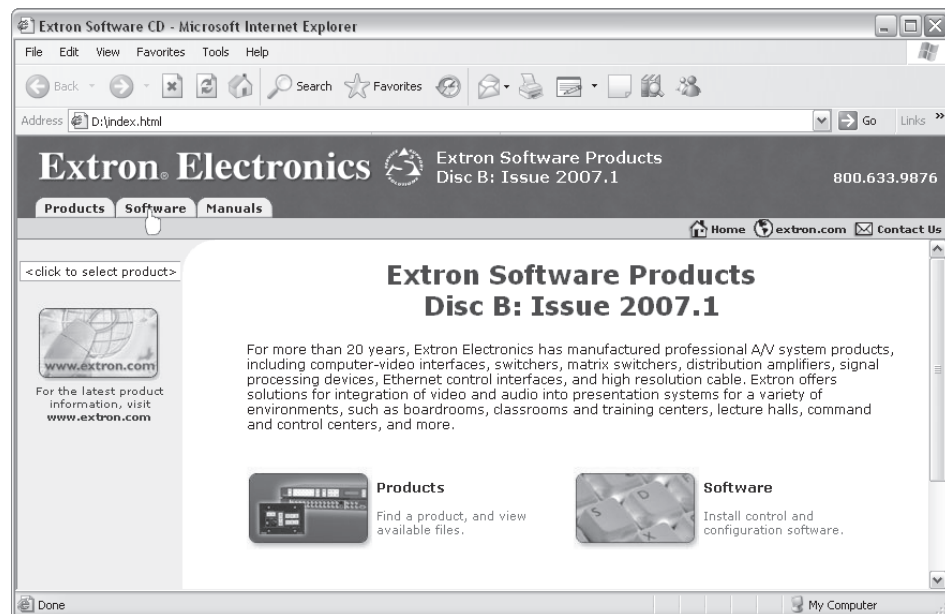


Figure 5-1 — Software CD window

2. Click the Software tab (figure 5-1).
3. Scroll to the desired program and click Install (figure 5-2).


• Matrix Switchers RS-232 Windows Control Program.  Release Notes	79-520-01	7.1	Sep 7, 2006	4.6 MB	▶ Install
---	-----------	-----	-------------	--------	-----------

Figure 5-2 — Software installation

- 
4. Follow the on-screen instructions. By default, the Windows installation of the Matrix Switchers Control Program creates a C:\Program Files\Extron\Matrix\_Switcher directory, and it places three icons into a group folder named “Extron Electronics\Matrix Switchers.” The three installed icons are:

- MATRIX Switcher+ Control Program
- MATRIX Switcher+ Help
- Uninstall MATRIX Switcher

**NOTE** *The CrossPoint 450 Plus or MAV Plus switcher can support remote control via either the rear panel Remote RS-232/RS-422 port or the front panel Configuration port (matrix sizes up to 1616).*

**Remote RS-232/RS-422 port** — *The port can be configured for either the RS-232 or RS-422 serial communication protocol and operate at the 9600, 19200, 38400, or 115200 baud rate. See “Selecting the rear panel Remote port protocol and baud rate” in chapter 3, “Operation”, to configure the rear panel port from the front panel.*

**Configuration port (matrix sizes up to 1616 only)** — *The port supports RS-232 serial communication protocol only. The port can operate at the 9600, 19200, 38400, or 115200 baud rate, but **Extron recommends leaving this port at the 9600 baud rate.** See the Set serial port parameters command on page 4-19 to configure either port using an SIS command.*

## Software operation via Ethernet

When a CrossPoint 450 Plus or MAV Plus switcher is connected to an Ethernet WAN or LAN, any number of users can operate it, locally or remotely, using the Matrix Switchers Control Program. See “Ethernet connection” in chapter 2, “Installation”, for installation details.

Connection to the switcher via the Ethernet is password protected. There are two levels of password protection: administrator and user. Administrators have full access to all CrossPoint 450 Plus or MAV Plus switching capabilities and editing functions. Users can select inputs and outputs, set and recall presets, and view all settings with the exception of passwords. If the same password or no password is required for logging on, all personnel log on with administrator privileges. Fields and functions that exceed user privileges are grayed out in the Matrix Switchers Control Program when the operator is logged on as a user.

### Ethernet protocol settings

The IP Settings/Options screen (figure 5-7 on page 5-7) provides a location for viewing and, if connected via a serial port or if logged on via the Ethernet port as an administrator, editing settings unique to the Ethernet interface. See “IP Settings/Options window” later in this chapter for more details.

# Matrix Software, cont'd

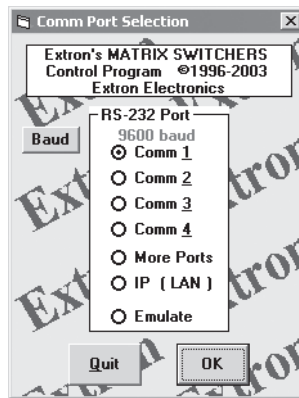
## Using the software

Many items found in the Matrix Switchers Control Program are also accessible via front panel controls (see chapter 3, “Operation”) and under SIS control (see chapter 4, “Programmer’s Guide”). The Matrix Switchers Help Program provides information on settings and on how to use the control program itself.

1. To run the Matrix Switchers Control Program, double-click on the Matrix Switchers Control Program icon (shown at right) in the Extron Electronics group or folder.

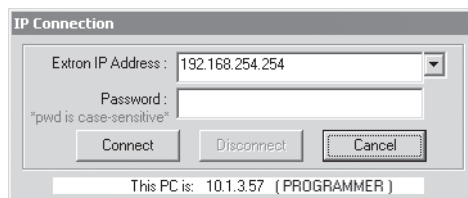


The Comm Port Selection window (figure 5-3) appears.



**Figure 5-3 — Comm port selection window**

2. Choose either the comm port that is connected to the CrossPoint 450 Plus or MAV Plus switcher’s serial port, *IP [LAN]*, or *Emulate*.
  - **If you selected a comm port**, check the baud rate displayed in the comm port selection window. If you need to change the baud rate, click on the Baud button and double-click on the desired baud rate.  
Available rates are 9600, 19200, 38400, and 115200. The default is 9600.  
Click *Ok* and proceed to step 4.
  - **If you selected *IP [LAN]***, click *Ok* and proceed to step 3.
  - **If you selected *Emulate***, click *Ok* and see “Using emulation mode” on page 5-22.
3. **If you selected *IP [LAN]* in step 2**, the IP Connection window appears (figure 5-4).



**Figure 5-4 — Address and password entry**

- a. Examine the Extron IP Address field in the IP Connection window. The field displays the last Extron IP address entered.

**If the IP address is correct:** Proceed to step 3b.

**If the address is not correct:** Either click in the Extron IP Address field and enter the IP address or click on the scroll down button (▼) and select from among the recently used addresses. Proceed to step 3b.

**NOTE** *If the local system administrators have not changed the value, the factory-specified default, 192.168.254.254, is the correct value for this field.*

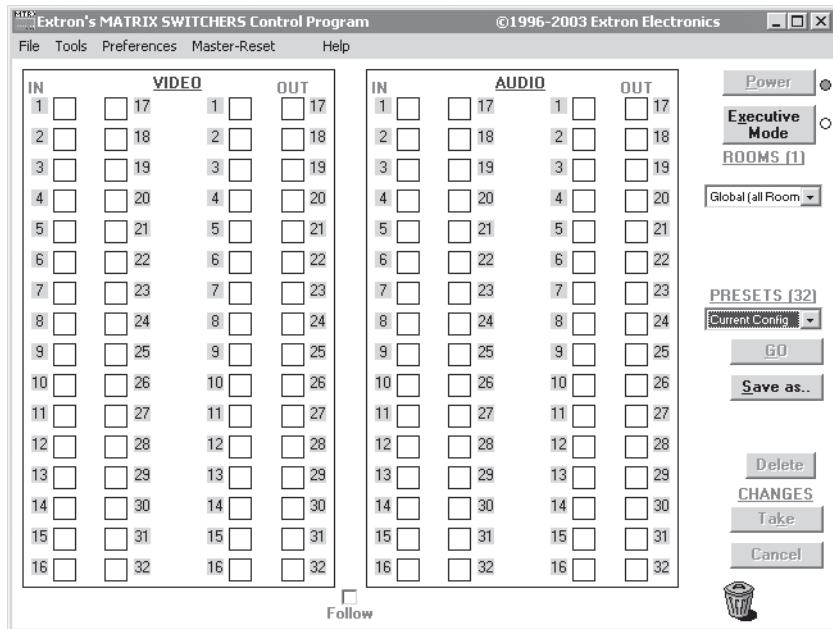
- b. If the switcher is password protected, click in the Password field and enter the appropriate administrator or user password.
- c. Click *Connect*.

If you logged on using the administrator password, the Windows program connects you to the CrossPoint 450 Plus or MAV Plus switcher with all of the administrator rights and privileges.

If you logged on using the user password, the Windows program connects you to the CrossPoint 450 Plus or MAV Plus switcher with only user capabilities.

If an incorrect password was entered, the program beeps and returns to the password entry display.

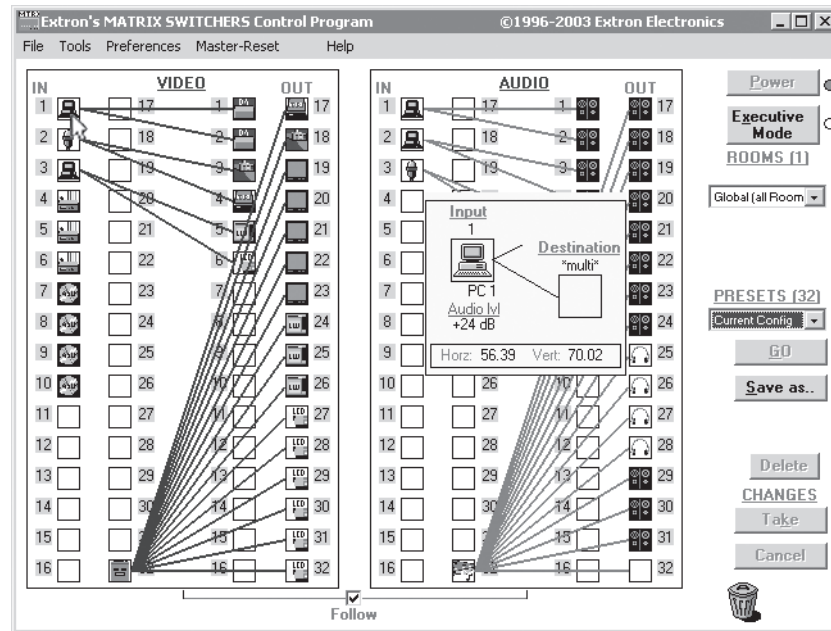
4. The Extron Matrix Switchers Control Program window (figure 5-5 and figure 5-6) appears. The window displays the current configuration of the attached matrix.



**Figure 5-5 — Extron Matrix Switchers Control Program window (blank)**



## Matrix Software, cont'd



**Figure 5-6 — Sample program window (complete)**

- To set up audio in follow mode (audio and video have the same tie configuration), select the Follow box at the bottom of the window. To set up audio in breakaway mode (audio and video have different tie configurations), deselect the Follow box.
- To make the control program easier to use, assign a device icon to each input and output. Click on a box that represents an input or output, and drag the desired icon onto the box from the icon palette that appears.
- To create a tie, drag an input box to one or more output boxes. To remove a tie, drag the output box to its tied input box or to the trash can.
- For quick display of information on a specific input or output device, position the cursor over that device in the control program window. The program opens a window that details the connections to that device, the audio level, and, for CrossPoint 450 Plus switchers only, the switching interval (RGB delay) and the frequency of the video signal input from or output to that device. See the inset box in figure 5-6.
- If desired, on the task bar, click on *Tools > IP Options* to set the switcher's IP parameters in the IP Settings/Options window (figure 5-7).

## IP Settings/Options window

The IP Settings/Options window (figure 5-7) provides a location for viewing and, if connected via either serial port or if logged on via the Ethernet port as an administrator, editing settings unique to the Ethernet interface. See appendix A, “Ethernet Connection”, for basic information about IP addresses. None of the fields on this screen can be edited while you are logged on as a user.

E-mail Addressee	None	Fail	Fixed	Both	Missing Input(s)	Fans	Power Supply
1 JSmith@folklore.net	<input type="radio"/>	<input type="radio"/>	<input type="radio"/>	<input checked="" type="radio"/>	<input type="checkbox"/>	<input checked="" type="checkbox"/>	<input type="checkbox"/>
2 Pocahontas@folklore.net	<input type="radio"/>	<input checked="" type="radio"/>	<input type="radio"/>	<input type="radio"/>	<input type="checkbox"/>	<input type="checkbox"/>	<input checked="" type="checkbox"/>
3	<input type="radio"/>	<input type="radio"/>	<input type="radio"/>	<input type="radio"/>	<input type="checkbox"/>	<input type="checkbox"/>	<input type="checkbox"/>
4 MStandish@folklore.net	<input checked="" type="radio"/>	<input type="radio"/>	<input type="radio"/>	<input type="radio"/>	<input checked="" type="checkbox"/>	<input type="checkbox"/>	<input type="checkbox"/>
5	<input type="radio"/>	<input type="radio"/>	<input type="radio"/>	<input type="radio"/>	<input type="checkbox"/>	<input type="checkbox"/>	<input type="checkbox"/>
6	<input type="radio"/>	<input type="radio"/>	<input type="radio"/>	<input type="radio"/>	<input type="checkbox"/>	<input type="checkbox"/>	<input type="checkbox"/>
7	<input type="radio"/>	<input type="radio"/>	<input type="radio"/>	<input type="radio"/>	<input type="checkbox"/>	<input type="checkbox"/>	<input type="checkbox"/>
8	<input type="radio"/>	<input type="radio"/>	<input type="radio"/>	<input type="radio"/>	<input type="checkbox"/>	<input type="checkbox"/>	<input type="checkbox"/>

**Figure 5-7 — Control program IP setting/options window**

**NOTE** *Editing variables on the IP Settings/Options screen while connected via the Ethernet port can immediately disconnect the user from the switcher. Extron recommends editing the settings on this screen using a serial port and protecting the Ethernet access to this screen by assigning an administrator’s password to qualified and knowledgeable personnel only.*

**NOTE** *When the control program is connected to the switcher via a serial port, the Administrator and User Password fields are not masked. If a password has been inadvertently changed to an unknown value, you can look up and, if desired, change a password in this window without knowing the current password.*

## Matrix Software, cont'd

---

### Matrix IP Address field

The Matrix IP Address field contains the IP address of the connected matrix switcher. This value is encoded in the flash memory in the switcher.

Valid IP addresses consist of four 1-, 2-, or 3-digit numeric subfields separated by dots (periods). Each field can be numbered from 000 through 255. Leading zeroes, up to 3 digits total per field, are optional. Values of 256 and above are invalid.

The default address is 192.168.254.254, but if this conflicts with other equipment at your installation, you can change the IP address to any valid value.

**NOTE** *Editing the Extron IP address while connected via the Ethernet port can immediately disconnect the user from the matrix switcher. Extron recommends editing this field using a serial port and protecting the Ethernet access to this screen by assigning an administrator's password to qualified and knowledgeable personnel only.*

Edit this field as follows:

1. Click in the Matrix IP address field. The graphic cursor becomes a text cursor.
2. Edit the address as desired.
3. Press the Tab key on the keyboard or click in another field to exit the Matrix IP Address field.
4. Click on the *Take* button to make the address change take affect.

### Extron Name/Descriptor field

The Extron Name/Descriptor field contains the name used as the “from” information when the CrossPoint 450 Plus or MAV Plus switcher e-mails notification of its failed or repaired status. This descriptor can be changed to any valid name, up to 12 alphanumeric characters.

**NOTE** *The following characters are invalid in the Extron Name/Descriptor field: {space} + ~ , @ = ' [ ] { } < > ' " ; : | \ and ?.*

Edit this field as follows:

1. Click in the Extron name/descriptor field. The graphic cursor becomes a text cursor.
2. Edit the name as desired.
3. Press the Tab key on the keyboard or click in another field to exit the Extron Name/Descriptor field.
4. Click on the *Take* button to make the name change take effect.

---

### **Gateway IP address field**

The Gateway IP Address field identifies the address of the gateway to the mail server to be used if the CrossPoint 450 Plus or MAV Plus switcher and the mail server are not on the same subnet.

Valid IP addresses consist of four 1-, 2-, or 3-digit numeric subfields separated by dots (periods). Each field can be numbered from 000 through 255. Leading zeroes, up to 3 digits total per field, are optional. Values of 256 and above are invalid.

Edit this field as follows:

1. Click in the Gateway IP Address field. The graphic cursor becomes a text cursor.
2. Edit the address as desired.
3. Press the Tab key on the keyboard or click in another field to exit the Gateway IP Address field.
4. Click the *Take* button to make the address change take affect.

### **Subnet Mask field**

The Subnet Mask field is used to determine whether the CrossPoint 450 Plus or MAV Plus switcher is on the same subnet as the controlling PC or the mail server when you are subnetting. For more information, see "Subnetting — A Primer", in Appendix A, "Ethernet Connection".

Edit this field as follows:

1. Click in the Subnet Mask field. The graphic cursor becomes a text cursor.
2. Edit the mask as desired.
3. Press the Tab key on the keyboard or click in another field to exit the Subnet Mask field.
4. Click the *Take* button to make the mask take affect.

### **Hardware Address field**

The hardware address is hardcoded in the CrossPoint 450 Plus or MAV Plus switcher and cannot be changed.

### **Use DHCP checkbox**


The Use DHCP checkbox directs the CrossPoint 450 Plus or MAV Plus switcher to ignore any entered IP addresses and to obtain its IP address from a Dynamic Host Configuration Protocol (DHCP) server (if the network is DHCP capable). Contact the local system administrator.

## Matrix Software, cont'd

---

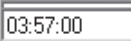
### Date field

The Date field displays the current date in the Greenwich Mean Time zone. If necessary, adjust the date as follows:

1. Click in the Date field. A set date field appears with the date in the format (M)M/(D)D/YYYY. Leading zeroes are not used. The graphic cursor becomes a text cursor in the set date field.  Date :
2. Edit the field as desired to set the proper date. Leading zeroes are optional.
3. Press the Tab key on the keyboard or click in another field to exit the set date field.
4. Click the *Take* button to make the date change take affect.

### Time (local) field

The Time (local) field displays the current time in the local time zone. If necessary, click on the Sync Time to PC button to set the switcher to your computer's internal time or else adjust the time manually as follows:


1. Click in the time field. A set time field appears with the date in the format HH:MM:SS (00:00:00 to 23:59:59). The graphic cursor becomes a text cursor in the set time field.  Time (local) :
2. Edit the field as desired to set the proper time. Remember to use 24-hour time. Leading zeroes are optional.
3. Press the Tab key on the keyboard or click in another field to exit the set time field.
4. Click the *Take* button to make the time change take affect.

### Sync Time to PC button

Clicking the mouse on the Sync Time to PC button causes the computer you are operating to send its internal time to the switcher in a set time command.

### GMT (offset) field

The GMT field displays the amount of time, in hours and minutes, that the local time varies from the GMT international time reference. If necessary, adjust the offset as follows:

1. Click in the GMT field. A set offset field appears with the offset in the format ±HH:MM (-12:00 to +14:00). The graphic cursor becomes a text cursor in the set offset field.  GMT
2. Edit the field as desired to set the proper offset. Leading zeroes are optional. Some time zones are on the half-hour (30 minutes).
3. Press the Tab key on the keyboard or click in another field to exit the Set Offset field.
4. Click the *Take* button to make the offset change take affect.

---

### Use Daylight Savings checkbox

Click in the Use Daylight Savings checkbox. When Daylight Savings Time is turned on, the switcher automatically updates its internal clock between Standard Time and Daylight Savings Time in the spring and fall on the date that the time change occurs in the country or region selected. When Daylight Savings Time is turned off, the switcher does not adjust its time reference.

### Administrator Password field

The Administrator Password field displays the password required to log on to the CrossPoint 450 Plus or MAV Plus switcher via the Ethernet port with all of the administrator's rights and privileges. Passwords are case sensitive and are limited to 12 upper case and lower case alphanumeric characters.

While you are logged on as a user, this field is masked with asterisks (\*\*\*\*\*) as a security measure.

**NOTE** *Editing the Administrator Password field while connected via the Ethernet port can immediately disconnect the user from the switcher. Extron recommends editing this field using a serial port and protecting the Ethernet access to this screen by assigning an administrator's password to qualified and knowledgeable personnel only.*

**NOTE** *The following characters are invalid in passwords: {space} + ~ , @ = ' [ ] { } < > ' " ; : | \ and ?.*

Edit this field as follows:

1. Click in the Administrator Password field. The graphic cursor becomes a text cursor.
2. Edit the case-sensitive password as desired.
3. Press the Tab key on the keyboard or click in another field to exit the Administrator Password field.
4. Click the *Take* button to make the password change take affect.

### User Password field

The User Password field displays the password required to log on to the CrossPoint 450 Plus or MAV Plus switcher via the Ethernet port as a user, without all of the administrator's rights and privileges. Passwords are case sensitive and are limited to 12 upper case and lower case alphanumeric characters.

While you are logged on as a user, this field is masked with asterisks (\*\*\*\*\*) as a security measure.

**NOTE** *An administrator password must be created before a user password can be created.*

**NOTE** *The following characters are invalid in passwords: {space} + ~ , @ = ' [ ] { } < > ' " ; : | \ and ?.*

Edit this field as follows:

1. Click in the User Password field. The graphic cursor becomes a text cursor.
2. Edit the case-sensitive password as desired.
3. Press the Tab key on the keyboard or click in another field to exit the User Password field.
4. Click the *Take* button to make the password change take affect.

## Matrix Software, cont'd

---

### Mail Server IP Address field

The Mail Server IP Address field displays the IP address of the mail server that handles the e-mail for the facility in which the CrossPoint 450 Plus or MAV Plus switcher is installed.

Valid IP addresses consist of four 1-, 2-, or 3-digit numeric subfields separated by dots (periods). Each field can be numbered from 000 through 255. Leading zeroes, up to 3 digits total per field, are optional. Values of 256 and above are invalid.

Edit this field as follows:

1. Click in the mail server IP address field. The graphic cursor becomes a text cursor.
2. Edit the IP address as desired.
3. Press the Tab key on the keyboard or click in another field to exit the mail server IP address field.
4. Click the *Take* button to make the address change take affect.

### Mail Server Domain Name field

The Mail Server Domain Name field displays the domain name that the CrossPoint 450 Plus or MAV Plus switcher uses to log on to the e-mail server. Standard domain conventions (such as *nnnnn@xxx.com*) apply.

**NOTE** *The following characters are invalid in a domain name: {space} + ~ , = ' [ ] { } < > ' " ; : | \ and ?. The @ character is only acceptable as the lead-in to the domain name (such as @folklore.net).*

Edit this field as follows:

1. Click in the Mail Server Domain Name field. The graphic cursor becomes a text cursor.
2. Edit the name as desired.
3. Press the Tab key on the keyboard or click in another field to exit the Mail Server Domain Name field.
4. Click the *Take* button to make the name change take affect.

### E-mail Addressee fields

The eight E-mail Addressee fields permit the administrator to identify the e-mail addresses of the personnel to whom the CrossPoint 450 Plus or MAV Plus switcher e-mails notification of its failure and repair status. Figure 5-8 shows a typical e-mail from the switcher.

Miles Standish	
<b>From:</b>	Crosspoint/MAV/Matrix-FF-FF-09@folklore.net
<b>Sent:</b>	Thursday, May 18, 2006 10:05 AM
<b>To:</b>	Miles Standish
<b>Subject:</b>	Crosspoint/MAV/Matrix-FF-FF-09 - Input #10 Signal Available
Thu, 18 May 2006 10:05:07	
Unit Name = Crosspoint/MAV/Matrix-FF-FF-09	
Unit IP Address = 192-168-254-254	

**Figure 5-8— Typical CrossPoint 450 Plus e-mail**

---

The radio buttons and check boxes associated with each address field permit the administrator to specify specific e-mail requirements for each recipient.

Edit these fields and controls as follows:

1. Click in the desired E-mail Addressee field. The graphic cursor becomes a text cursor.
2. Edit the e-mail address as desired. Standard e-mail address conventions (for example: *nnnnn@xxx.com*) apply.
3. Press the Tab key on the keyboard or click in another field to exit the e-mail addressee field.
4. In the square check boxes associated with each addressee, select the options about which the addressee is to be e-mailed: missing input(s), fans, and/or power supply. In the floating box that contains the input numbers, select the inputs that need monitoring.
5. In the round radio buttons associated with each addressee, select whether the addressee is to be e-mailed of failures, fixes, both, or not be notified. The None radio button is useful for temporarily removing personnel from the e-mail list when they are unavailable, such as on travel or vacation.
6. If desired, click on the *Send test E-mail* button to test the e-mail function.
7. Click on the *Take* button to make the e-mail address changes take affect.

## Update firmware

The firmware upgrade utility provides a way to replace the firmware that is coded on the switcher's control board without taking the switcher out of service.

**NOTE** *The Firmware Loader must be installed on your computer to perform this operation. Extron recommends that you install this program when you install the Matrix Switchers Control Program. If you did not, it can be downloaded from the Extron Web site, [www.extron.com](http://www.extron.com), and installed separately.*

**NOTE** *The update firmware utility is for replacing the firmware that controls all switcher operation. This is **not** the page to insert your own HTML pages. See "Upload HTML files" to insert custom HTML pages.*

Update the switcher firmware as follows:

1. Visit the Extron web site, [www.extron.com](http://www.extron.com), click the Download Center tab, and then click the Firmware link (figure 5-9). Select the appropriate firmware file to download and copy it to your computer. Note the folder to which you save the firmware file.



**Figure 5-9 — Location of firmware upgrade files**

2. In the Windows Explorer or other file browser, double-click the downloaded executable (\*.exe) file to self-extract the firmware file.



## Matrix Software, cont'd

3. Connect a Windows-based computer to either switcher serial port or the switcher LAN port. See chapter 2, “Installation”, for more details.
4. Start the Matrix Switchers Control Program. See “Using the software” in this chapter, steps 1 through 4, starting on page 5-4.

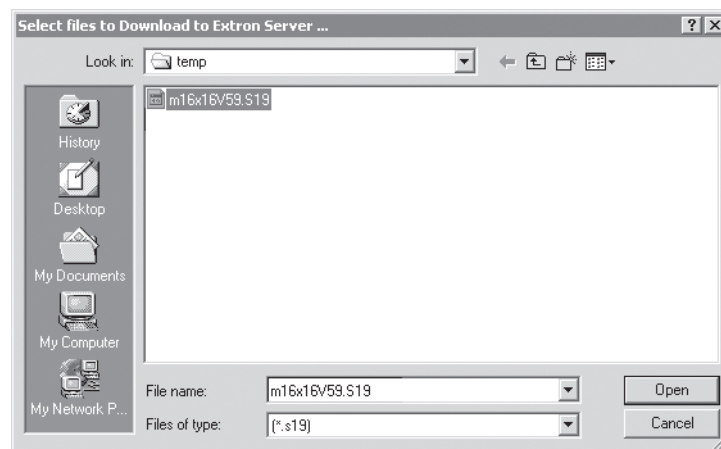
**NOTE** *The Ethernet connection is much faster than the serial port connections. Extron recommends using the Ethernet connection rather than the serial port for firmware uploads.*

5. Click *Tools > Update firmware*.

**If you are connected via the LAN port**, the select file window appears (figure 5-10). See “Ethernet-connected firmware upload”, below.

**If you are connected via either serial port**, the Extron Firmware Loader appears (figure 5-11). See “Serial-port-connected firmware upload”, on page 5-15.

### Ethernet-connected firmware upload



**Figure 5-10 — Select file window**

6. Navigate to the folder where you saved the firmware upgrade file. Select the file.

**NOTE** *Valid firmware files must have the file extension .S19. Any other file extension is not a firmware upgrade.*

**NOTE** *The original factory-installed firmware is permanently available on the CrossPoint 450 Plus or MAV Plus switcher. If the attempted firmware upload fails for any reason, the switcher reverts to the factory-installed firmware.*

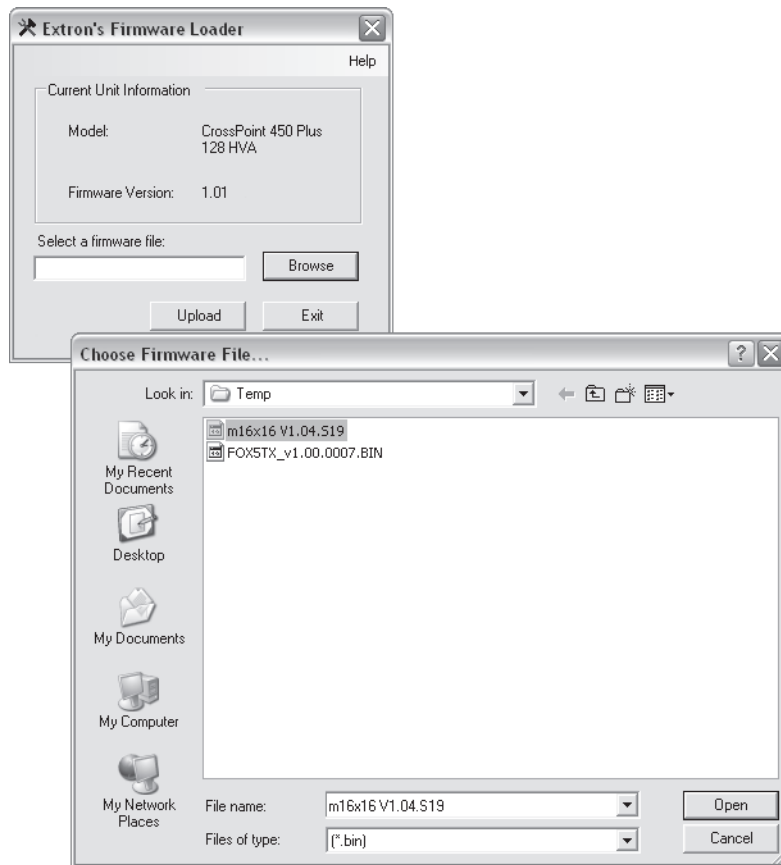
7. Click the *Open* button. The software advises you that you are about to reprogram the switcher’s firmware. Click *Ok* to continue.

A status window, which shows the progress of the upload, appears. The firmware upload to the CrossPoint 450 Plus or MAV Plus switcher may take a few minutes.



---

## Serial-port-connected firmware upload



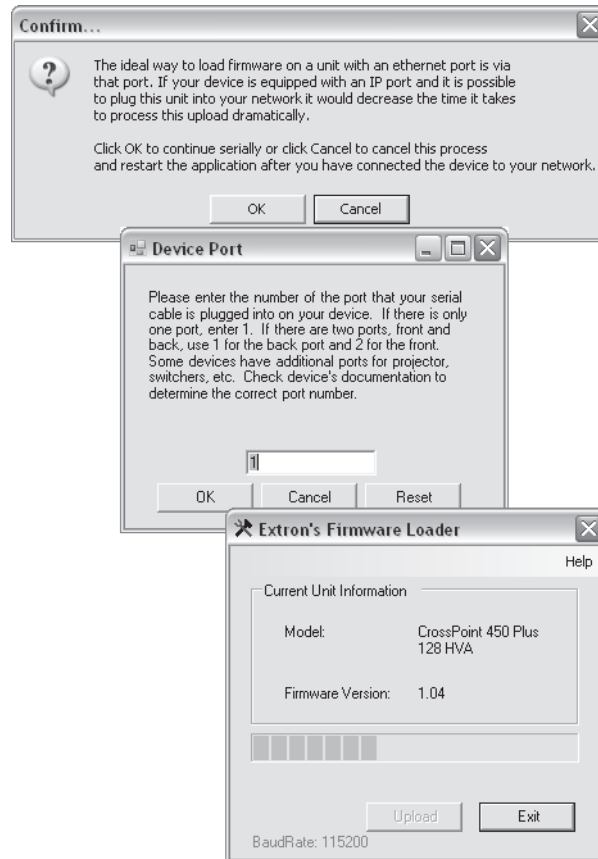
**Figure 5-11 — Firmware loading**

6. Click **Browse**. The open file window appears.
7. Navigate to the folder where you saved the firmware upgrade file. Select the file and click **Open**. The Firmware Loader returns to the top.

**NOTE** *Valid firmware files must have the file extension “.S19”. Any other file extension is not a firmware upgrade for your matrix switcher.*

## Matrix Software, cont'd

- Click *Upload*. The File Loader advises you that using the Ethernet (LAN) port is preferred over using either serial port (figure 5-12).



**Figure 5-12 — Confirm window**

To quit the firmware upload and start over using the LAN port, click the *Cancel* button and return to step 3. Use the LAN port connection in step 3.

To continue the firmware upload using either serial port connection, click the *Ok* button. The program prompts you to identify the serial port to which you are connected. Continue to step 9.

- If necessary, change the port number in the device port field:
  - Rear panel RS-232/RS-422 port, enter 1.
  - Front panel Configuration port, enter 2.

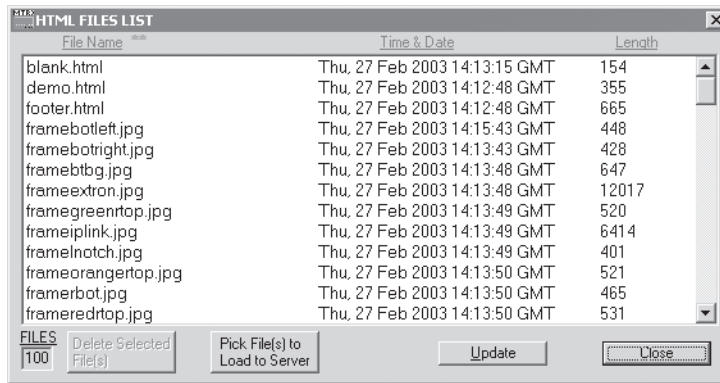
Click the *Ok* button. The Firmware Loader reports, “*This process could take several minutes. Please wait...*”, then displays a status bar that shows the progress of the upload. When the upload is complete, the Firmware Loader reports “*Unit resetting, this can take some time, please wait. ...*”, and then “*Transfer complete!*”.

**NOTE** Firmware upgrades using either serial port can take **several minutes**.

- When the Firmware Loader reports, “*Transfer complete!*”, click the *Exit* button on the Firmware Loader and then again on the port configuration window. The Firmware Loader and the Matrix Switchers Control Program exit.

## Upload HTML files

You can create customized HTML pages for the switcher to display. The HTML Files List window (figure 5-13) provides a way to view the contents of the switcher's file system and upload custom HTML pages to the switcher.



**Figure 5-13 — HTML Files List window**

Upload HTML pages as follows:

**NOTE** The files listed in figure 5-13 are shown for example only and may not be present on your switcher.

**NOTE** The HTML Files List window is for inserting your own HTML pages. This is *not* the window to replace the firmware that controls all switcher operation. See Update firmware in this chapter to replace the firmware.

**NOTE** The following characters are invalid in file names: {space} + ~ , @ = ' [ ] { } < > ' " ; : | \ and ?.

1. Connect the PC to the CrossPoint 450 Plus or MAV Plus switcher via the switcher's serial port or Ethernet port.
2. Start the Matrix Switchers Control Program and connect to the CrossPoint 450 Plus or MAV Plus switcher. See "Using the software" in this chapter, steps 1 through 4, starting on page 5-4.
3. Click on *Tools > HTML File Manager*.
4. Click on the *Pick File(s) to Load to Server* button. An open file window appears.
5. Navigate to the folder where you saved the HTML file(s). Select the file(s).

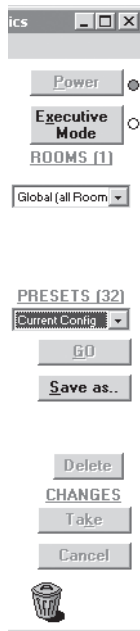
**NOTE** To select multiple files, hold the *Ctrl* key while you select the desired files.

**NOTE** If you want one of the HTML files that you created to be the default start-up page, name the file "index.html". The CrossPoint 450 Plus or MAV Plus switcher automatically looks for that file name when you first connect to it using an Internet browser.

6. Click on the *Open* button. The file(s) upload to the CrossPoint 450 Plus or MAV Plus switcher may take a few minutes.
7. Click on the *Update* button to confirm the upload.
8. Click on the *Close* button to exit the HTML Files List window.

## Windows buttons, drop boxes, and trash

The buttons, drop boxes, and trash can on the right side of the program window perform the following functions:



**Power** — Unavailable for CrossPoint 450 Plus and MAV Plus switchers, because the switcher power cannot be controlled via software.

**Executive mode** — Allows you to lock out front panel operations, except for the view-only mode functions. Click the button to cycle between *Lock mode 0* (the indicator displays white), *Lock mode 1* (the indicator displays red), and *Lock mode 2* (the indicator displays orange).

**NOTE** See “Setting the front panel locks (Executive modes)” in chapter 3, “Operation” for more information on the Lock modes.

**Room menu** — Displays a list of up to 10 rooms. You can select a room from the list to display it in the window.

**NOTE** A **Room** is a subset of outputs that are logically related to each other, as determined by the operator. The CrossPoint 450 Plus or MAV Plus switcher supports up to 10 rooms, each of which can consist of from 1 to 16 outputs.

**Presets menu** — Displays a list of up to 32 global presets and up to 100 room presets (10 rooms x 10 presets per room). You can select a preset from the list to display it in the window and either activate it (**Go**) or delete it (**Delete**).

**Go** — Activates the selected preset as the current configuration.

**Save as** — Allows the current set of ties to be saved as a preset. Enter the preset number when prompted to do so.

**Delete** — Allows the current preset to be deleted.

**Changes - Take** — Allows you to save to file any changes made to the displayed configuration.

**Changes - Cancel** — Returns to the previous screen, undoing any changes you have made.

**Trash can** — Drag and drop from an input or output button to the trash can to unmake all ties associated with that input or output.

---

## Windows menus

### File menu

**Save matrix settings as** — Saves a complete set of up to 32 presets, plus the last active setting (preset #0), to a file. Saved settings include audio gain settings (if specified), assigned icons, and icon captions.

**Restore matrix settings from** — Loads and activates a previously saved setting file.

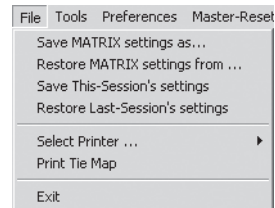
**Save this-session's settings** — Saves the current assigned icons and icon captions.

**Restore last-session's settings** — Loads the icons and icon captions that were saved during the last session. If you saved the previous session's changes to disk the last time you exited the program, the ties from that session are also loaded.

**Select printer** — Selects the target printer.

**Print tie map** — Prints the tie set that is displayed on the screen.

**Exit** — Closes the MATRIX Switcher+ Control Program.



### Tools menu

**Assign device icons** — Displays the complete set of input and output device icons. You can drag any of these icons to the input and output boxes.

**Edit device palette** — Allows you to add your own device icon graphics.

**RGB delay settings** — Displays the switching interval setting for each input and allows you to change them.

**Audio-Input gain settings** — Displays the audio gain level setting for a single input or for all inputs and allows you to change it. The level is expressed as the magnitude (number of decibels) and polarity (positive, gain or negative, attenuation) of the audio adjustment.

**Audio-Output volume settings** — Displays the audio output level setting for a single input or for all inputs and allows you to change it. The level is expressed as a percentage of the input audio volume that is applied to the output; 0% is full attenuation (audio is silent), 100% is full volume.

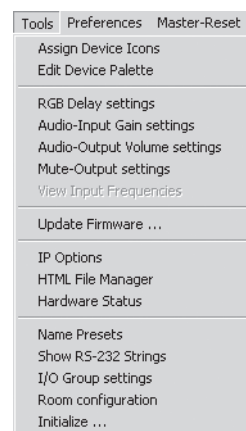
**Mute-Output settings** — Displays the RGB Delay, Volume, and Mute Adjust screen, which allows you to mute and unmute individual or all video and audio outputs.

**View input frequencies** — (DSVP) Displays the input horizontal and vertical frequencies for each input.

**Update firmware** — Allows you to replace the firmware that is coded on the switcher's control board without taking the switcher out of service, opening the switcher enclosure, and replacing the firmware chip set. See "Update firmware" on page 5-13.

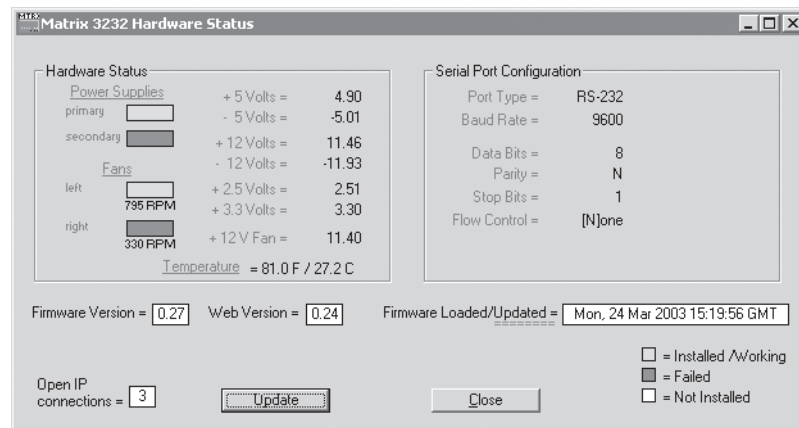
**IP options** — Allows you to set IP options. See "IP Settings/Options window" on page 5-7.

**HTML file manager** — Displays a list of HTML files installed on the switcher and allows you to upload custom files from a connected PC to the switcher. See "Upload HTML files" on page 5-17.



## Matrix Software, cont'd

**Hardware status** — Provides an overall view of the status of the matrix switcher, including the primary and secondary power supply status and the individual voltages, the fan and temperature status, the Remote RS-232/RS-422 port configuration, and the installed and updated firmware status (figure 5-14).



**Figure 5-14** — Status window

- = Installed / Working    **Green** — Proper operation.
- = Failed    **Red** — Component has failed.
- = Not Installed    **White** — Components are not installed.

**NOTE** The CrossPoint 450 Plus and MAV Plus switchers are not available in custom configurations. Each model has all available monitored components, such as power supplies and fans, installed. If you see the white “not installed” indication, the “not installed” component probably became disconnected during shipment or rough handling.

**NOTE** Smaller switchers (16 x 16 matrix sizes and smaller) do not show the power supply and fan status blocks.

**Name presets** — Allows you to assign a name to each of the 32 memory presets.

**NOTE** Preset names are limited to 12 uppercase and lowercase alphanumeric characters, space, and the \_ and / characters.

**NOTE** The following characters are invalid in preset names:  
+ ~ , @ = ' [ ] { } < > ' " ; : | \ and ?.

**Show RS-232 strings** — Displays the ASCII commands that are used by the current configuration. You can refer to these for SIS command programming.

**I/O group settings** — Allows you to establish I/O groups.

**Room configuration** — Allows you to assign outputs to rooms or delete outputs from rooms.

**NOTE** A **Room** is a subset of outputs that are logically related to each other, as determined by the operator. The CrossPoint 450 Plus or MAV Plus switcher supports up to 10 rooms, each of which can consist of from 1 to 16 outputs.

**Initialize** — Initializes and clears any or all of the following: ties, presets, audio configuration, preset names, icon names, and icons.

## Preferences menu

**Immediate changes** — Causes configuration changes to take effect immediately.

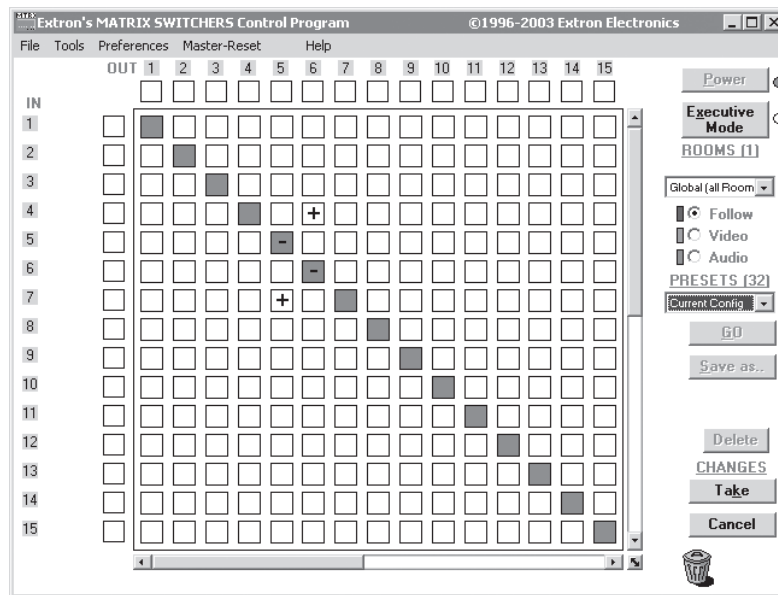
**Hold/verify changes** — Delays implementation of configuration changes until the Changes – Take button is pressed.

**Ties as lines** — Displays ties as lines (figure 5-15).



**Figure 5-15 — Ties shown as lines**

**Ties as crosspoints** — Displays ties as a matrix of inputs and outputs (figure 5-16). Ties that have been made are indicated as **amber** (video and audio), **green** (video only), and **red** (audio only) boxes. Ties that will take effect when you click on the *Take* button are indicated by +. Ties that will be broken when you click on the *Take* button are indicated by –.

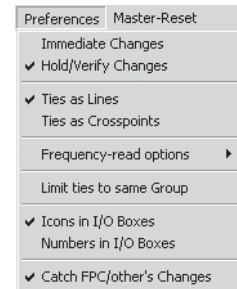


**Figure 5-16 — Ties shown as crosspoints**

**Frequency read options** (CrossPoint 450 Plus only) — Allows you to set the input signal detection (DSVP) feature as follows:

- To never sample and display the sync or no sync status (set this option to **None**)
- To automatically refresh the display (set this option to **Automatically every 10 seconds**)
- To sample the sync and update the display whenever you make a configuration change (set this option to **On demand or by refresh**).


**Limit ties to same group** — Allows you to limit the creation of ties using the program to inputs and outputs that are in the same group (similar to front panel operation).





## Matrix Software, cont'd

---

**Icons in I/O boxes** — Erases any numbers in the I/O boxes in the Control Program window (figure 5-6). You can place icons in the boxes. 

**Numbers in I/O boxes** — Erases any icons in the I/O boxes in the Control Program window and fills each box with the associated input or output number. 

**Catch FPC/others changes** — When checked, sets the switcher to report all configuration and setting changes to the serial port or Ethernet connection that turned this selection on. These reports allow the Matrix Switchers Control Program to track the changes that occur in the switcher's configuration and settings, whether commanded via the front panel, the either serial port, or the Ethernet port.

### Master-Reset selection

Master reset clears all ties and presets, all video and audio mutes, resets all I/O grouping, sets all input audio levels to unity gain (+0 dB), and sets all output volume levels to 100% (0 dB of attenuation).

**NOTE** *Master reset does not reset the Internet protocol (IP) settings.*

## Using emulation mode

Emulation mode allows you to set up the software without attaching the switcher to the computer. To use emulation mode, do the following:

1. Double-click the MATRIX Switchers+ Control Program icon in the Extron Electronics group or folder.
2. Choose Emulate, and click *Ok*.
3. Choose an emulation file to open, and click on *Ok*. The file DEMO.MTX provides a sample of a completed matrix setup. Selecting the file NEW.INI or clicking *Cancel* provides a blank setup to get you started.
4. Enter the file name under which you want to save any changes to the file, and click *Ok*.
5. Select the number of video boards, audio boards, and matrix model for which you are preparing a configuration, and click *Ok*.
6. Continue using the program as described on page 5-6.

## Using the help system

For information about program features, you can access the help program in any of the following ways:

- From the Extron Electronics program folder or group, double-click on the MATRIX Switcher+ Help icon (shown at right).
- From within the Matrix Switcher Control Program, click on the Help menu on the main screen.
- From within the Matrix Switcher Control Program, press the F1 key.



## Special Characters

The HTML language reserves certain characters for specific functions. The switcher will not accept these characters as part of preset names, the switcher's name, passwords, or locally created file names.

The switcher rejects the following characters:

{space (spaces are ok for names)} + ~ , @ = ' [ ] { } < > ' " semicolon (;) colon (:) | \ and ?.

## Button-Label Generator

The Button Label Generator software creates labels that you can place in the translucent covers of the input select buttons. You can create labels with names, alphanumeric characters, or even color bitmaps for easy and intuitive input and output selection. See appendix B, “Reference Information”, for the procedure for removing and replacing the translucent covers.

The Extron Button Label Generator is available on the Extron Web site, [www.extron.com](http://www.extron.com), under the Download Center tab. Click the Software link (figure 5-17), and download and install the program.



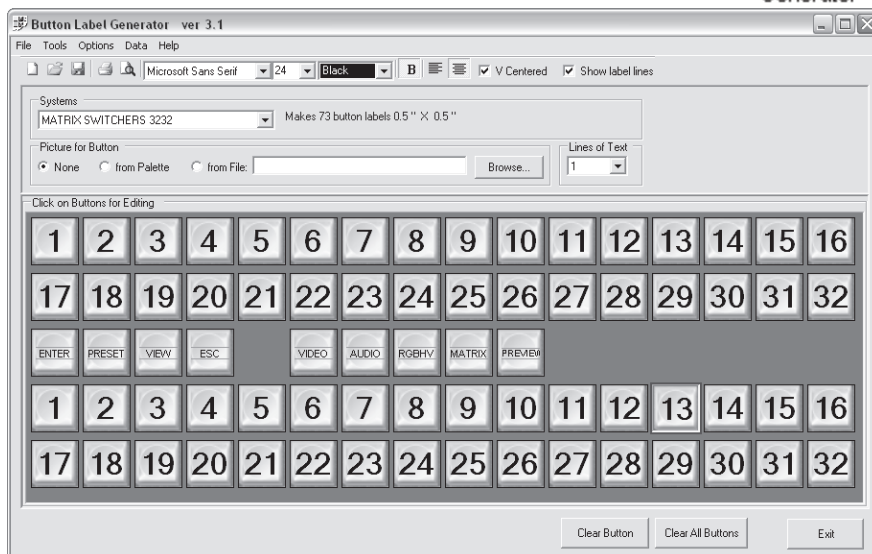
**Figure 5-17** — Location of Software on the web site.

**NOTE** The Button Label Generator software is also included on the Extron Software Products CD-ROM that accompanied the switcher.

By default, the Windows installation creates a C:\Program Files\Extron\ButtonLabelGenerator directory and places the Button Label Generator icon into a group or folder named “Extron Electronics”.

## Using the software

1. To run the Button-Label Generator program, double-click on the Button-Label Generator icon (shown at right) in the Extron Electronics group or folder, and click OK when prompted. The Button-Label Generator window appears (figure 5-18).



**Figure 5-18** — Extron’s Button-Label Generator window

## Matrix Software, cont'd

---

2. In the Systems selection, choose the appropriate matrix size.
3. Using normal Windows controls, you can create and print labels that can be placed in the label windows on the front panel of the switcher.
4. Press the *Clear All Buttons* button to create new labels as many times as necessary to make all of the button labels that you need.

Access the Help program by clicking on the Help menu. Click on the Help menu on the main screen, choose Show Help, and click on the Load Demo button to see an example of a completed Extron's Button-Label Generator window.



## CrossPoint 450 Plus and MAV Plus Switchers

# Chapter Six

## HTML Operation

Download the Startup Page

System Status Page

System Configuration Page

File Management Page

Set and View Ties Page

Special Characters

# HTML Operation

The switcher can be controlled and operated through its Ethernet port, connected via a LAN or WAN, using a web browser such as Microsoft's Internet Explorer. The browser's display of the switcher's status or operation has the appearance of web pages. This chapter describes the factory-installed HTML pages, which are always available and cannot be erased or overwritten.

**NOTE** *If your Ethernet connection to the matrix switcher is unstable, try turning off the proxy server in your Web browser. In Microsoft's Internet Explorer, click Tools > Internet Options > Connections > LAN Settings, uncheck the "Use a proxy server..." box, and then click Ok.*

## Download the Startup Page

Access the switcher using HTML pages as follows:

1. Start the Web browser program.
2. Click in the browser's Address field.
3. Enter the Matrix IP address in the browser's Address field.

**NOTE** *If the local system administrators have not changed the value, the factory-specified default, 192.168.254.254, is the correct value for this field.*

4. If you want the browser to display a page other than the default page (such as a custom page that you have uploaded), enter a slash (/) and the file name to open.

**NOTE** *The browser's Address field should display the address in the following format: xxx.xxx.xxx.xxx/{optional\_file\_name.html}*

**NOTE** *The following characters are invalid in file names: {space} + ~ , @ = ' [ ] { } < > ' " ; : | \ and ?.*

5. Press the keyboard Enter key. The switcher checks to see if it is password protected.

If the switcher is not password protected, proceed to step 7.

If the switcher is password protected, the switcher downloads the Enter Network Password page (figure 6-1).



**Figure 6-1 — Enter Network Password page**

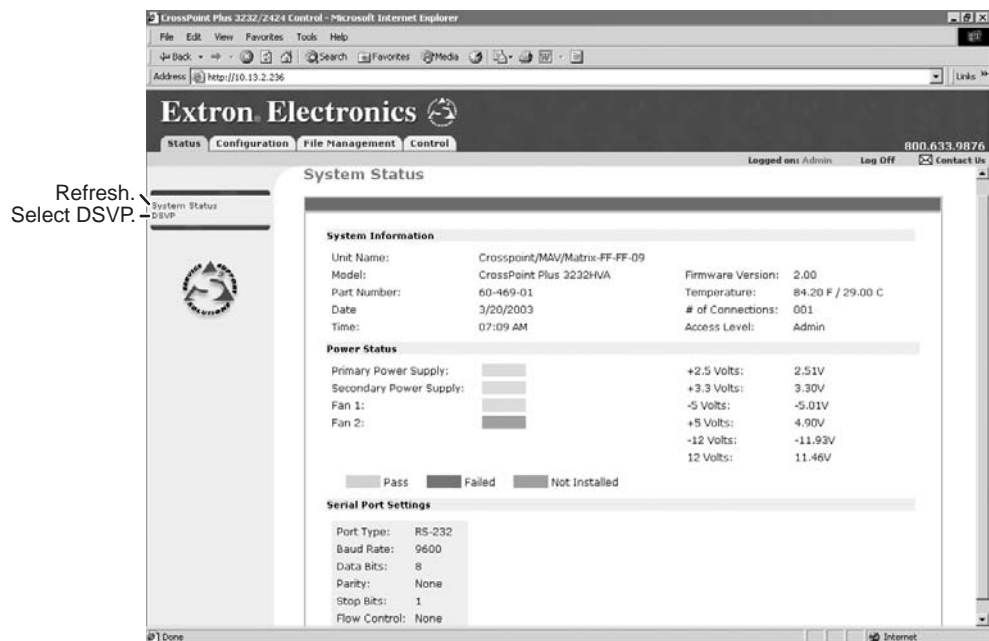
**NOTE** *A User Name entry is not required.*

6. Click in the Password field and type in the appropriate administrator or user password. Click the OK button.
7. The switcher checks several possibilities, in the following order, and then responds accordingly:
  - a. Does the address include a specific file name, such as 10.13.156.10/file\_name.html? **If so**, the switcher downloads that HTML page.

- b. Is there a file in the switcher’s memory that is named “index.html”?  
If so, the switcher downloads “index.html” as the default startup page.
- c. If neither of the above conditions is true, the switcher downloads the factory-installed default startup page, “nortxe\_index.html” (figure 6-2), also known as the System Status page.

## System Status Page

The System Status page (figure 6-2) provides an overall view of the status of the matrix switcher, including the primary and secondary power supply status, the individual voltages, and the fan status (if applicable). The System Status page is the default page that the switcher downloads when you connect to the switcher. Access the System Status page from other pages by clicking the *Status* tab.



**Figure 6-2 — System Status page**

- Pass      Components that are operating properly are indicated in green.
- Failed      Failures are indicated in red.
- Not Installed      Components that are not installed are indicated in gray.

The status web page automatically updates itself periodically to reflect the latest status of the switcher components.

**NOTE** *The CrossPoint 450 Plus and MAV Plus switchers are not available in custom configurations. Each model has all available monitored components, such as power supplies and fans, installed. If you see the gray “not installed” indication, the “not installed” component probably became disconnected during shipment or rough handling.*

**NOTE** *Smaller switchers (16 x 16 matrix sizes and smaller) do not show the power supply and fan status blocks.*

If a component fails or becomes disconnected, the display shows the change in status the next time it updates.

## HTML Operation, cont'd

### DSVP page (CrossPoint 450 Plus switchers only)

You can view a snapshot-in-time of the input frequencies of connected inputs on the Digital Sync Validation Processing (DSVP) page (figure 6-3). Click the DSVP link to the left of the Status page to download the DSVP page. The DSVP page automatically updates itself every 30 seconds to show the latest input frequencies changes or if an input has been disconnected.

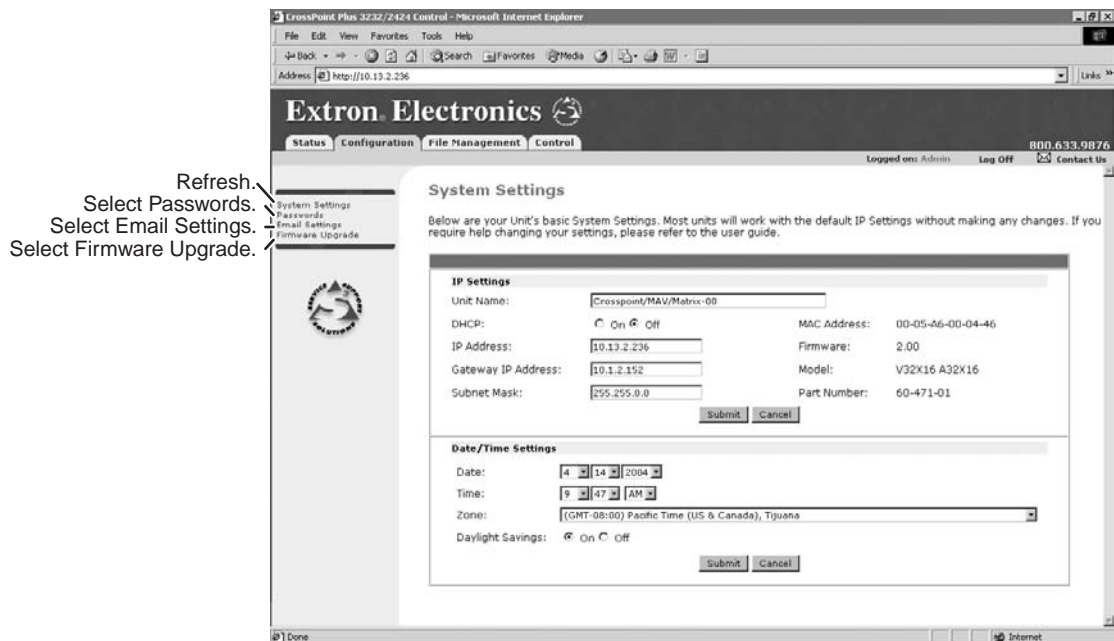
Select System Status. Refresh.

Input Frequencies			
Input	Horizontal (kHz)	Vertical (Hz)	Name
001	037.87	060.30	
005	037.86	060.29	Input #05
009	037.86	060.29	Input #09
013	037.87	060.30	Input #13
017	037.86	060.30	Input #17

Figure 6-3 — DSVP page

## System Configuration Page

The CrossPoint 450 Plus or MAV Plus switcher downloads the System Configuration page (figure 6-4) when you click the *Configuration* tab. The screen consists of fields in which you can view and edit IP administration and system settings. The Email Settings and Passwords pages can be accessed by clicking the appropriate link. See appendix A, “Ethernet Connection”, for basic information about IP addresses and subnetting.



**Figure 6-4 — System Configuration page**

On password-protected connections, there are two levels of protection: administrator and user. Administrators have full access to all switching capabilities and editing functions. Users can create ties, create and recall presets, set RGB and audio mutes, and view all settings with the exception of passwords.

- Ethernet connection to the switcher, either entering SIS commands (see chapter 4, “Programmer’s Guide”) or using the Extron Matrix Switcher+ Control Program (see chapter 5, “Matrix Software”) is password protected.
- Connection via the RS-232/RS-422 port **is not** password protected.



## HTML Operation, cont'd

---

### IP Settings fields

The IP Settings fields provide a location for viewing and editing settings unique to the Ethernet interface. After editing any of the settings on this page, click the *Submit* button at the bottom of the page.

#### Unit Name field

The Unit Name field contains the name used as the “from” information when the switcher e-mails notification of its failed or repaired status. This name field can be changed to any valid name, up to 24 alphanumeric characters.

**NOTE** *The following characters are invalid in the matrix name: + ~ , @ = ' [ ] { } < > ' " ; : | \ and ?.*

#### DHCP radio buttons

The DHCP On radio button directs the switcher to ignore any entered IP addresses and to obtain its IP address from a Dynamic Host Configuration Protocol (DHCP) server (if the network is DHCP capable). The DHCP Off radio button turns DHCP off. Contact the local system administrator.

#### IP Address field

The IP Address field contains the IP address of the connected switcher. This value is encoded in the switcher’s flash memory.

Valid IP addresses consist of four 1-, 2-, or 3-digit numeric subfields separated by dots (periods). Each field can be numbered from 000 through 255. Leading zeroes, up to 3 digits total per field, are optional. Values of 256 and above are invalid.

The factory-installed default address is 192.168.254.254, but if this conflicts with other equipment at your installation, you can change the IP address to any valid value.

**NOTE** *IP address changes can cause conflicts with other equipment. Only local system administrators should change IP addresses.*

#### Gateway IP Address field

The Gateway IP Address field identifies the address of the gateway to the mail server to be used if the switcher and the mail server are not on the same subnet.

The gateway IP address has the same validity rules as the system IP address.

#### Subnet Mask field

The Subnet Mask field is used to determine whether the switcher is on the same subnet as the mail server when you are subnetting. For more information, see “Subnetting — A Primer”, in Appendix A, “Ethernet Connection”.

#### MAC Address field

The Media Access Control (MAC) Address is hardcoded in the switcher and cannot be changed.

---

## Date/Time Settings fields

The Date/Time Settings fields (figure 6-5) provide a location for viewing and setting the time functions.

The screenshot shows a web-based configuration interface titled "Date/Time Settings". It includes the following elements:

- Date:** Three dropdown menus for month (4), day (14), and year (2004).
- Time:** Two dropdown menus for hour (2) and minute (35), followed by a "2004" label.
- Zone:** A dropdown menu currently showing "(GMT-08:00)" and a text input field containing "Time (US & Canada), Tijuana".
- Daylight Savings:** Two radio buttons, with "On" selected.
- Buttons:** "Submit" and "Cancel" buttons at the bottom right.
- Scroll Bar:** A vertical scroll bar on the right side of the form, indicating a list of years from 2004 to 2014.

**Figure 6-5 — Date/Time Settings fields**

Change the date and time settings as follows:

1. Click the desired variable's drop box. The adjustable variables are month, day, year, hours, minutes, AM/PM, and (time) zone. A drop down scroll box appears (the year drop box is selected in figure 6-5).
2. Click and drag the slider or click the scroll up ▲ button or scroll down ▼ button until the desired variable is visible.
3. Click the desired variable.

**NOTE** *If setting the time, set the local time. The Zone variable allows you to then enter the offset from Greenwich Mean Time (GMT).*

**NOTE** *The Zone field identifies the standard time zone selected and displays the amount of time, in hours and minutes, that the local time varies from the GMT international time reference.*

4. Repeat steps 1 through 3 for other variables that need to be changed.
5. If appropriate, click in the Daylight Savings radio button to turn on the daylight savings time feature.

**NOTE** *When daylight savings time is turned on, the switcher automatically updates its internal clock between Standard Time and Daylight Savings Time in the spring and fall on the date that the time change occurs in the country or region selected. When Daylight Savings Time is turned off, the switcher does not adjust its time reference.*

6. Click the *Submit* button.

# HTML Operation, cont'd

## Passwords page

Access the Passwords page (figure 6-6) by clicking the Passwords link on the System Settings page.



**Figure 6-6 — Passwords page**

The fields on the Passwords page are for entering and verifying administrator and user passwords. Passwords are case sensitive and are limited to 12 uppercase and lowercase alphanumeric characters. Each password must be entered twice; once in the Password field and then again in the Re-enter Password field. Characters in these fields are masked by asterisks (\*\*\*\*\*). If you do not want to password protect an access level, leave the Password field and the Re-Enter password field blank. After entering the desired password in both fields, click the *Submit* button.

**NOTE** *An administrator password must be created before a user password can be created.*

To clear an existing password so that no password is required, erase the existing password and enter a space in the Password and Re-enter Password fields and click the *Submit* button.

## Email Settings page

Reach the Email Settings page (figure 6-7) by clicking the Email Settings link on the System Configuration page. The Email Settings page has fields for setting up the switcher's e-mail notification capabilities. For the e-mail settings and for each row of the e-mail notification settings, click the *Edit* button to make the fields available for editing. The button changes to *Save*. After editing the settings associated with the *Edit/Save* button, click the *Save* button.

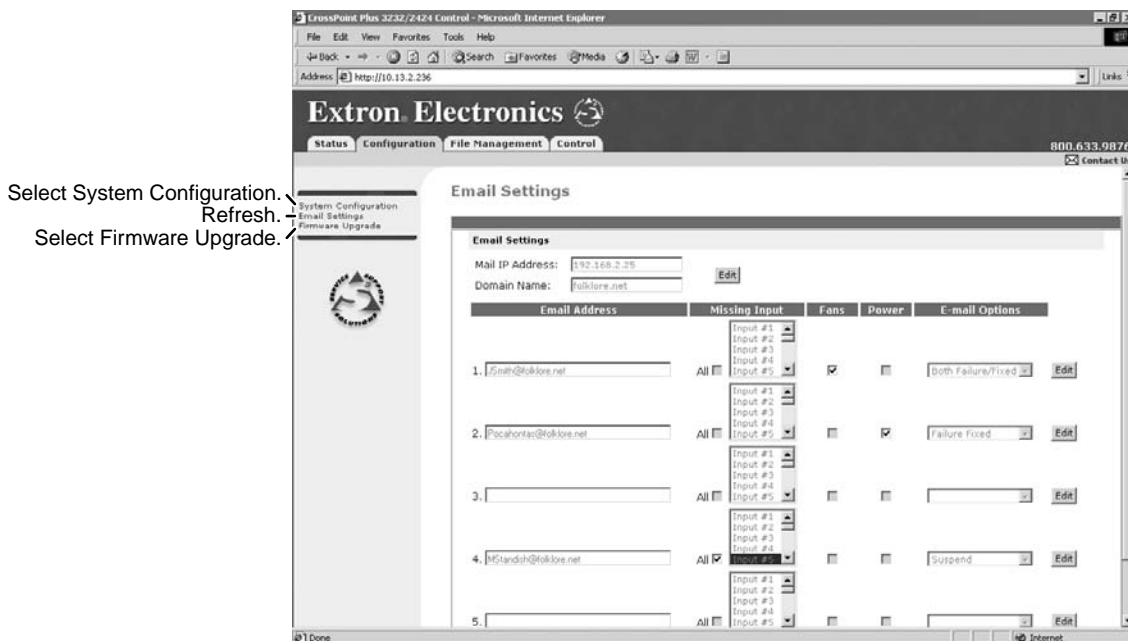


Figure 6-7 — Email Settings page

### Mail IP Address field

The Mail IP Address field displays the IP address and the domain name of the mail server that handles the e-mail for the facility in which the CrossPoint 450 Plus or MAV Plus switcher is installed.

Valid IP addresses consist of four 1-, 2-, or 3-digit numeric subfields separated by dots (periods). Each field can be numbered from 000 through 255. Leading zeroes, up to 3 digits total per field, are optional. Values of 256 and above are invalid.

### Domain Name field

The Domain Name field displays the domain name that the CrossPoint 450 Plus or MAV Plus switcher uses to log on to the e-mail server. Standard domain name conventions (for example: *nnnnn@xxx.com*) apply.

**NOTE** The following characters are invalid in a domain name: {space} + ~ , = ' [ ] { } < > ' " ; : | \ and ?. The @ character is only acceptable as the lead-in to the domain name (such as @folklore.net).

## HTML Operation, cont'd

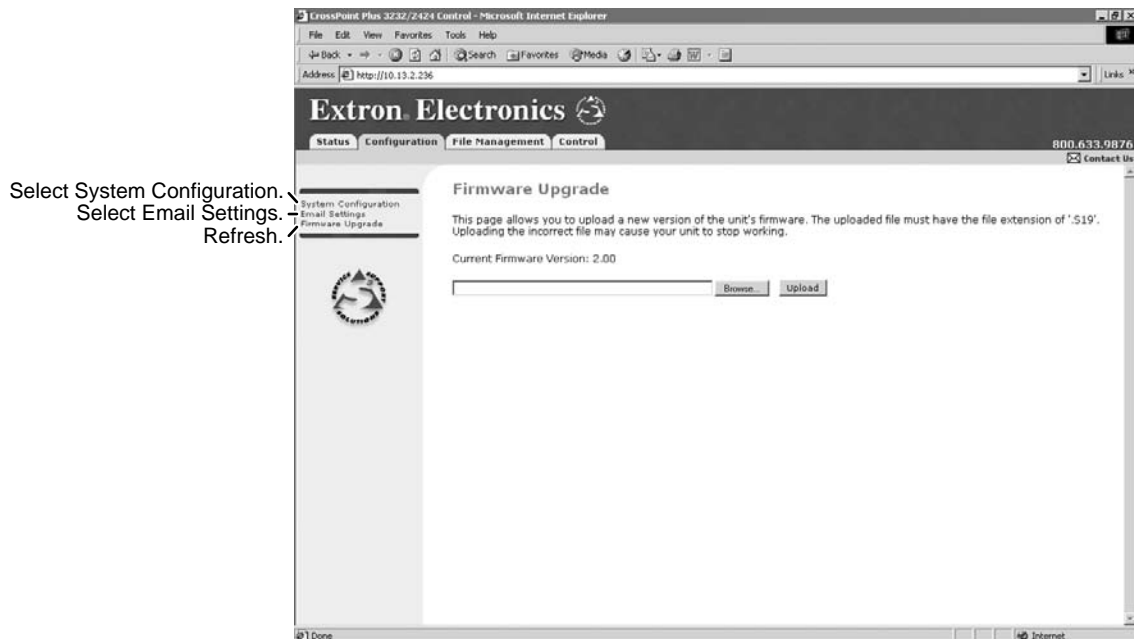
### Email address fields

The eight Email address fields identify the e-mail addresses of the personnel to whom the CrossPoint 450 Plus or MAV Plus switcher e-mails notification of its failure and repair status. Standard e-mail address conventions (*nnnnn@xxx.com*) apply.

The check boxes and drop boxes associated with each address field permit the operator to specify specific criteria under which the switcher will e-mail recipients. In the associated Missing Input drop boxes, select the inputs to monitor for presence or absence of a signal. Check the Fans and Power boxes to monitor the cooling and power supplies. In the associated E-Mail Options drop box, select whether the recipient is to be e-mailed of failures, fixes, both, not notified, or to be removed from the e-mail list. The Suspend option is useful for temporarily removing personnel from the e-mail list when they are unavailable, such as on travel or vacation. Deleting an e-mail addressee and clicking the submit button removes the recipient from e-mail notification completely.

### Firmware Upgrade page

The Firmware Upgrade page provides a way to replace the firmware that is coded on the switcher's control board without taking the switcher out of service, opening the switcher enclosure, and replacing the firmware chip. Access the Firmware Upgrade page (figure 6-8) by clicking the Firmware Upgrade link on the System Configuration page.



**Figure 6-8** — Firmware Upgrade page

Update the switcher firmware as follows:

**NOTE** *The Firmware Upgrade page is **only** for replacing the firmware that controls all switcher operation. To insert your own HTML pages, see "File Management Page", on page 6-11.*

1. Visit the Extron web site, [www.extron.com](http://www.extron.com), select the CrossPoint/MAV Plus product category, and select the latest firmware file for download. Note the folder to which you save the firmware file.

2. Connect the PC to the CrossPoint 450 Plus or MAV Plus switcher via the switcher's Ethernet port.
3. Access the CrossPoint 450 Plus or MAV Plus switcher using HTML pages.
4. Click the Configuration tab.
5. Click the Firmware Upgrade link.
6. Click the *Browse* button. An open file window appears.
7. Navigate to the folder where you saved the firmware upgrade file. Select the file.

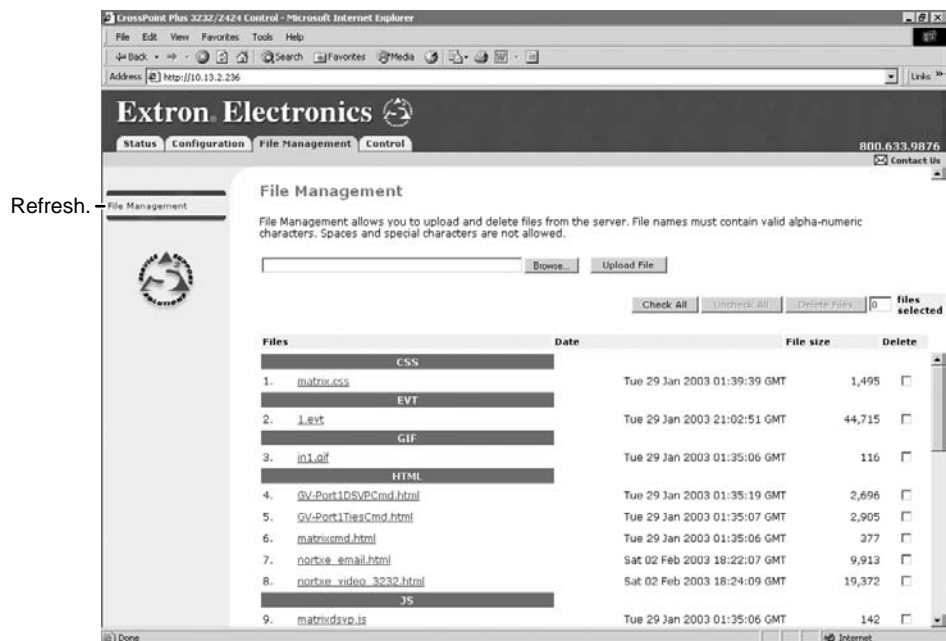
**NOTE** Valid firmware files must have the file extension '.S19'. Any other file extension is **not** a firmware upgrade.

**NOTE** The original factory-installed firmware is permanently available on the CrossPoint 450 Plus or MAV Plus switcher. If the attempted firmware upload fails for any reason, the switcher automatically reverts to the factory-installed firmware.

8. Click the *Open* button.
9. Click the *Upload* button. The firmware upload to the CrossPoint 450 Plus or MAV Plus switcher may take a few minutes.

## File Management Page

To delete files such as HTML pages from the switcher or to upload your own files to the switcher, click the File Management tab. The switcher downloads the file management HTML page (figure 6-9).



**Figure 6-9** — File Management page

**NOTE** The files listed in figure 6-9 are shown for example only and may not be present on your switcher.

To delete a file, check the associated delete check box and click the *Delete Files* button.

## HTML Operation, cont'd

Upload your own files as follows:

**NOTE** The following characters are invalid in file names: {space} + ~ , @ = ' [ ] { } < > ' " ; : | \ and ?.

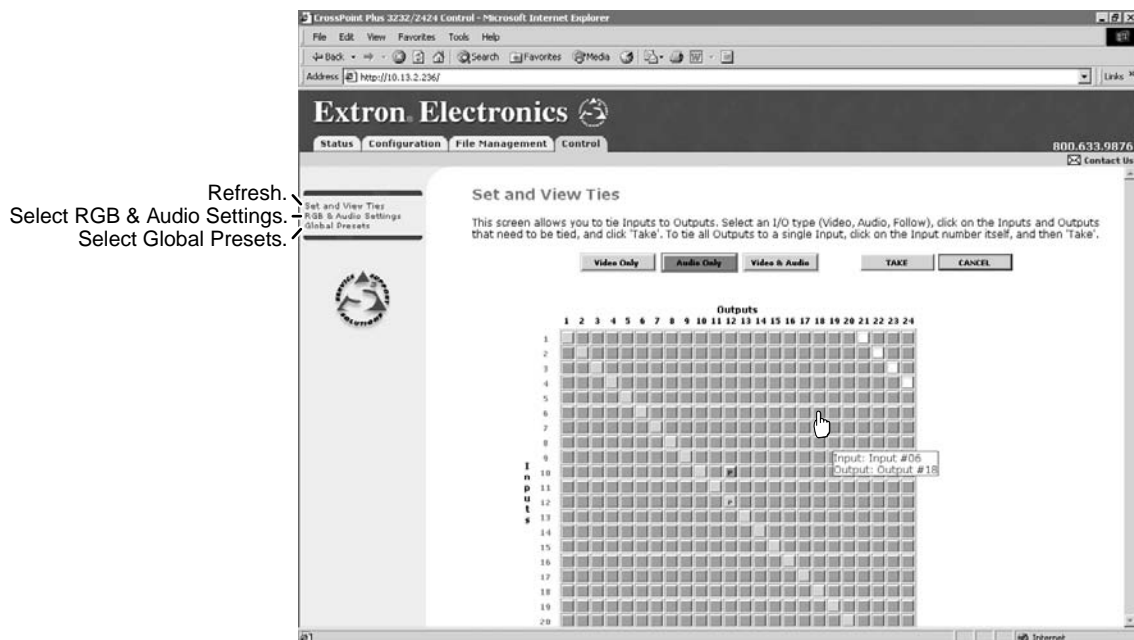
1. Click the *Browse* button.
2. Browse through your system and select the desired file(s).

**NOTE** If you want one of the pages that you create and upload to be the default startup page, name that file "index.html".

3. Click the *Upload File* button. The file(s) that you selected appear in the list.

## Set and View Ties Page

You can create ties on the Set and View Ties page (figure 6-10). Access the Set and View Ties page by clicking the *Control* tab.



**Figure 6-10 — Set and View Ties page**

The page consists of a matrix of input (rows) and output (columns) selection buttons of four different colors:

- The **amber** buttons indicate **video and audio ties**.
- The **green** buttons indicate **video only ties**.
- The **red** buttons indicate **audio only ties**.
- The **gray** buttons indicate **no ties**.

**NOTE** If you lose track of the input and output associated with a specific button, let the mouse pointer rest over a button for a moment. As shown on figure 6-10, a field pops up that identifies the input and output for that button.

## Create or delete a tie

Make or break a tie as follows:

1. Click the *Video Only*, *Audio Only*, or *Video & Audio* button to select video, audio, or both for switching (audio follow or audio breakaway). Each mouse click on a button toggles the other two buttons off.
2. Move the mouse over the matrix of input and output selection buttons. Click a button to:
  - Create a preliminary tie (if not tied) of the input and output associated with that button.
  - Create a preliminary untie (if tied) of the input and output associated with that button.

A “P” (for preliminary) appears in the button.

**NOTE** *If you lose track of the input and output associated with a specific button, let the mouse rest over one of the tie buttons for a moment. A field pops up (as shown on figure 6-10) that identifies the input and output for that button.*

**NOTE** *To tie an input to all outputs, click that input's input number.*

3. Click the *Take* button to make the configuration changes or *Cancel* button to abandon the configuration changes.

## RGB and Audio Settings page

The RGB and Audio Settings page provides a way to set the input audio gain and attenuation, set the output volume, mute and unmute all video and audio outputs, and (for CrossPoint 450 Plus switchers only) set the RGB delay (switching interval). Access the RGB and Audio Settings page (figure 6-11) by clicking the RGB & Audio Settings link on the Control page.

Select Set & View Ties.  
Refresh.  
Select Global Presets.

**Figure 6-11 — RGB and Audio Settings page**



## HTML Operation, cont'd

---

### Change the input gain and attenuation (audio models only)



Users can set each input's level of audio gain or attenuation (-18 dB to +24 dB) from the RGB and Audio Settings page. Audio levels can be adjusted so there are no noticeable volume differences between sources.

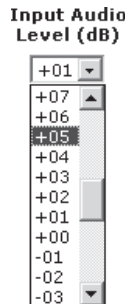
Change an input's audio level setting as follows:

1. Click the Input drop box. A drop down scroll box appears (figure 6-12).





**Figure 6-12 — Input selection drop box**

2. Click and drag the slider or click on the scroll up  button or scroll down  button until the desired input is visible.
3. Click the desired input.
4. Click the Input Audio Level (dB) drop box. A drop down scroll box appears (figure 6-13).



**Figure 6-13 — Gain drop box**

5. Click and drag the slider or click on the scroll up  button or scroll down  button until the desired input is visible.
6. Click the desired gain or attenuation value.

---

## Mute and unmute one or all outputs

Mute one or all outputs as follows:

1. To select an individual output to mute or unmute, click the Output drop box. A drop down scroll box appears (figure 6-14).

Output



**Figure 6-14 — Output selection drop box**

2. Click and drag the slider or click the scroll up ▲ button or scroll down ▼ button until the desired output is visible.
3. Click the desired output.
4. Click the *Video*, *Audio*, or *Follow* button to select video, audio, or both for muting. Each mouse click on a button toggles the other two buttons off.
5. Click the *Mute* or *UnMute* button to mute or unmute the selected output. Click the *Mute All* or *UnMute All* to mute or unmute all of the outputs.

Observe the Mute status indications on the page (figure 6-15). Unmuted is displayed in green and muted is displayed in red.

**Mute Status**

<b>RGB</b>	<b>Audio</b>
UnMuted	Muted

**Figure 6-15 — Mute status indications**

## HTML Operation, cont'd

---

### Change the RGB delay (CrossPoint 450 Plus switchers only)

The RGB delay interval defines how long the screen is blanked when switching to a new input for the selected output.



Change the RGB delay as follows:

1. Click the Output drop box. A drop down scroll box appears (figure 6-16).

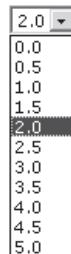
Output



**Figure 6-16 — Output selection drop box**

2. Click and drag the slider or click on the scroll up  button or scroll down  button until the desired output is visible.
3. Click the desired output.
4. Click the RGB delay drop box. A drop down scroll box appears (figure 6-17).

RGB Delay  
(Seconds)



**Figure 6-17 — RGB delay drop box**

5. Click the desired RGB delay.

---

### Change the output volume level (audio models only)

Users can set each output's volume level through a range of zero steps of attenuation (full attenuation, minimum volume) to 64 steps of attenuation (no attenuation, full volume) from the RGB and Audio Settings page.

Change an output's audio level setting as follows:

1. Click the output drop box. A drop down scroll box appears (figure 6-18).

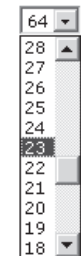
Output



**Figure 6-18 — Output selection drop box**

2. Click and drag the slider or click the scroll up ▲ button or scroll down ▼ button until the desired output is visible.
3. Click the desired output.
4. Click the Volume Steps (64 Max) drop box. A drop down scroll box appears (figure 6-19).

Volume Steps (64 Max)



**Figure 6-19 — Volume drop box**

5. Click the desired output volume step value.

**NOTE** The table on the next page defines the value of each audio volume step.

## HTML Operation, cont'd

### Audio volume adjustment settings

Number of steps	dB of attenuation	Output volume	Number of steps	dB of attenuation	Output volume	Number of steps	dB of attenuation	Output volume
00	76	0%						
01	63	5.5%	23	41	38.5%	45	19	71.5%
02	62	7%	24	40	40%	46	18	73%
03	61	8.5%	25	39	41.5%	47	17	74.5%
04	60	10%	26	38	43%	48	16	76%
05	59	11.5%	27	37	44.5%	49	15	77.5%
06	58	13%	28	36	46%	50	14	79%
07	57	14.5%	29	35	47.5%	51	13	80.5%
08	56	16%	30	34	49%	52	12	82%
09	55	17.5%	31	33	50.5%	53	11	83.5%
10	54	19%	32	32	52%	54	10	85%
11	53	20.5%	33	31	53.5%	55	9	86.5%
12	52	22%	34	30	55%	56	8	88%
13	51	23.5%	35	29	56.5%	57	7	89.5%
14	50	25%	36	28	58%	58	6	91%
15	49	26.5%	37	27	59.5%	59	5	92.5%
16	48	28%	38	26	61%	60	4	94%
17	47	29.5%	39	25	62.5%	61	3	95.5%
18	46	31%	40	24	64%	62	2	97%
19	45	32.5%	41	23	65.5%	63	1	98.5%
20	44	34%	42	22	67%	64	0	100%
21	43	35.5%	43	21	68.5%			
22	42	37%	44	20	70%			

## Global Presets page

You can save and recall global presets from the Global presets page (figure 6-20). Access the Global presets page by clicking the Global Presets link on the left of the Control page.

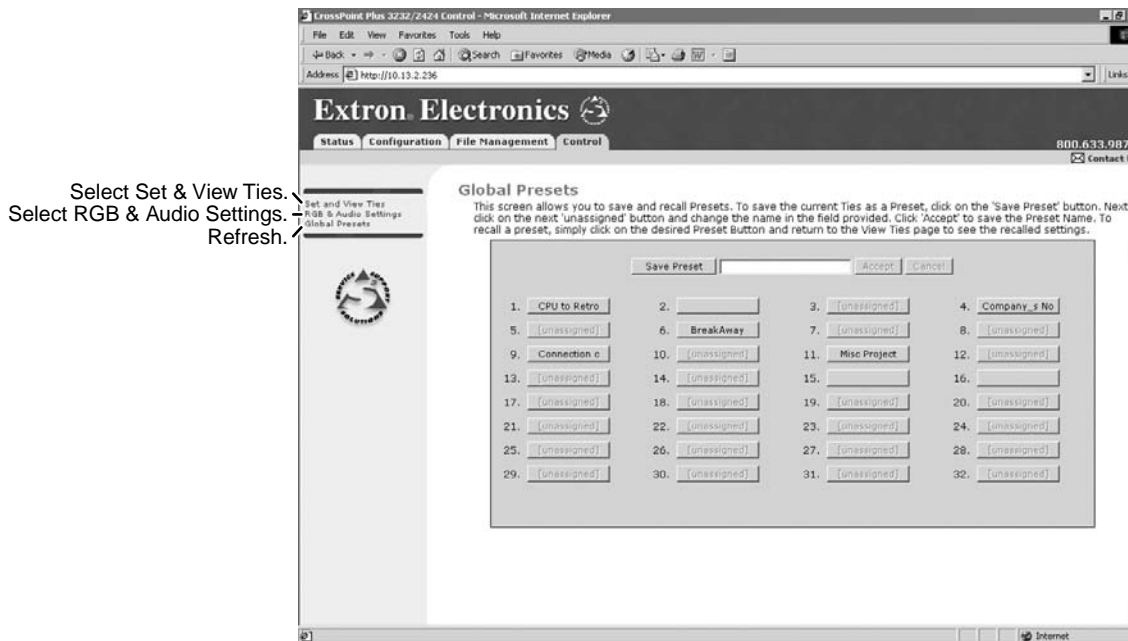


Figure 6-20 — Global Presets page

### Save a preset

Save the current configuration (configuration 0) as a preset as follows:

1. Click the *Save Preset* button.
2. Select the desired preset by clicking on one of the presets listed. To create a new preset, click one of the *[unassigned]* buttons. Overwrite an existing preset by clicking an already existing preset.
3. If desired, type over the current name in the box adjacent to the *Save Preset* button.

**NOTE** Preset names are limited to 12 uppercase and lowercase alphanumeric characters and the {space} \_ and / characters.

**NOTE** The following characters are invalid in preset names:  
+ ~ , @ = ' [ ] { } < > ' " ; : | \ and ?.

If you do not rename an unassigned button, the CrossPoint 450 Plus or MAV Plus switcher automatically names the preset as Preset {next available number}.

If you do not rename an existing preset when it is overwritten, the CrossPoint 450 Plus or MAV Plus switcher retains the same name.

4. Click the *Accept* button.

### Recall a preset

To recall a global preset to be the current configuration, click the button associated with the desired preset.

### Special Characters

The HTML language reserves certain characters for specific functions. The switcher will not accept these characters as part of preset names, the switcher's name, passwords, or locally created file names.

The switcher rejects the following characters:

{space} + ~ , @ = ' [ ] { } < > ' " semicolon (;) colon (:) | \ and ?.



# CrossPoint 450 Plus and MAV Plus Switchers

# A

## Appendix A

## Ethernet Connection

Ethernet Link

Subnetting — A Primer



# Ethernet Connection

## Ethernet Link

The rear panel Ethernet connector on the CrossPoint 450 Plus or MAV Plus switcher can be connected to an Ethernet LAN or WAN. This connection makes SIS control of the switcher possible using a computer connected to the same LAN.



## Ethernet connection

The Ethernet cable can be terminated as a straight-through cable or a crossover cable and must be properly terminated for your application (figure A-1).

- **Crossover cable** — Direct connection between the computer and the CrossPoint 450 Plus or MAV Plus switcher.
- **Patch (straight) cable** — Connection of the CrossPoint 450 Plus or MAV Plus switcher to an Ethernet LAN.

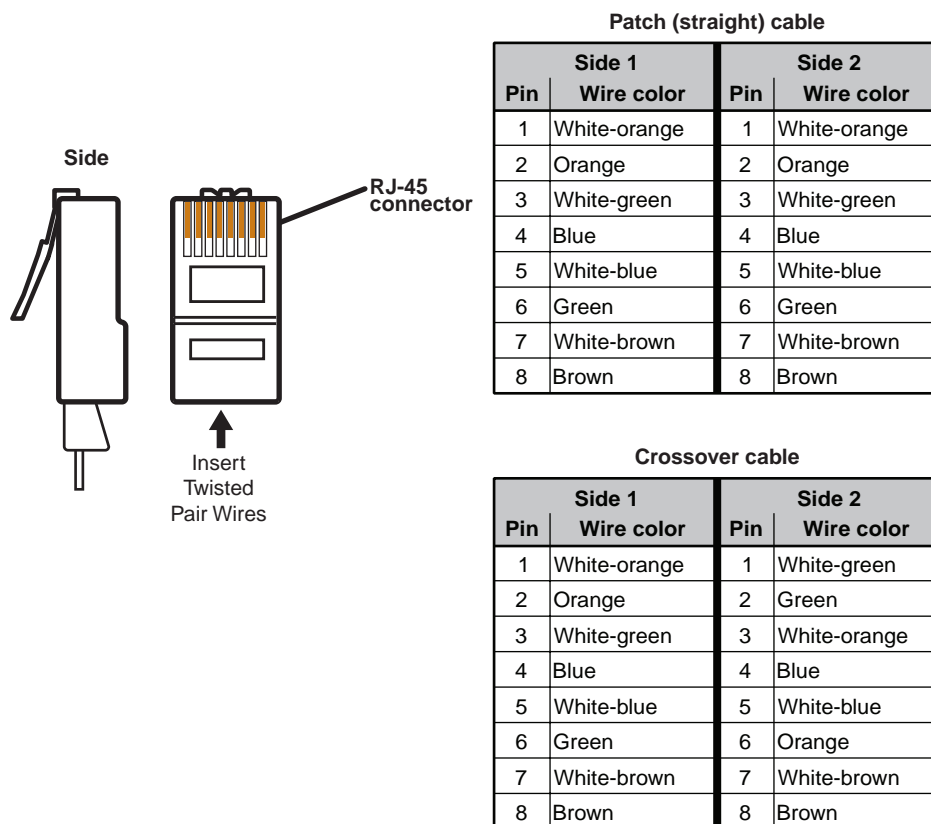


Figure A-1 — RJ-45 connector pinout tables

## Default address

To access the CrossPoint 450 Plus or MAV Plus switcher via the Ethernet port, you will need the switcher's IP address. If the address has been changed to an address comprised of words and characters, the actual numeric IP address can be determined using the Ping utility. If the address has not been changed, the factory-specified default is 192.168.254.254.

Ping can also be used to test the Ethernet link to the CrossPoint 450 Plus or MAV Plus switcher.

---

### Ping to determine Extron IP address

The Microsoft Ping utility is available at the DOS prompt. Ping tests the Ethernet interface between the computer and the CrossPoint 450 Plus or MAV Plus switcher. Ping can also be used to determine the actual numeric IP address from an alias and to determine the web address.

Ping the switcher as follows:

1. On the Windows task bar, click on *Start > Run*.
2. At the Open prompt, type *command*.
3. Click on the *OK* button.
4. At the DOS prompt, type *ping {IP address}* and then press [Enter]. The computer returns a display similar to figure A-2.

The line **Pinging ...** reports the actual numeric IP address, regardless of whether you entered the actual numeric IP address or an alias name.

```
C:\>ping 192.168.254.254

Pinging 192.168.254.254 with 32 bytes of data:

Reply from 192.168.254.254: bytes=32 time<10ms TTL=128
Reply from 192.168.254.254: bytes=32 time<10ms TTL=128
Reply from 192.168.254.254: bytes=32 time<10ms TTL=128
Reply from 192.168.254.254: bytes=32 time<10ms TTL=128

Ping statistics for 192.168.254.254:
    Packets: Sent = 4, Received = 4, Lost = 0 (0% loss),
    Approximate round trip times in milli-seconds:
        Minimum = 0ms, Maximum = 0ms, Average = 0ms
```

**Figure A-2 — Ping response**

### Ping to determine Web IP address

The Ping utility has a modifier, *-a*, that directs the command to return the Web address rather than the numeric IP address.

At the DOS prompt, type *ping -a {IP address}* and then press [Enter]. The computer's return display is similar to the Ping response shown in figure A-2, except that when you specify the *-a* modifier, the line **Pinging mail...** reports the web IP address rather than the numeric IP address, regardless of whether you entered the actual numeric IP address or an alias name.

### Connect as a Telnet client

The Microsoft Telnet utility is available from the DOS prompt. Telnet allows you to input SIS commands to the CrossPoint 450 Plus or MAV Plus switcher from the PC via the Ethernet link and the LAN.

Access the DOS prompt and start Telnet as follows:

1. On the Windows task bar, click on *Start > Run*.
2. At the Open prompt, type *command*.
3. Click on the *OK* button.
4. At the DOS prompt, type *telnet* and then press [Enter]. The computer returns a display similar to figure A-3.

## Ethernet Connection, cont'd

---

```
Microsoft (R) windows 2000 (TM) Version 5.0 (Build 2195)
Welcome to Microsoft Telnet Client
Telnet Client Build 5.00.99203.1

Escape Character is 'CTRL+]'

Microsoft Telnet>
```

**Figure A-3 — Telnet screen**

### Telnet tips

It is not the intention of this manual to detail all of the operations and functionality of Telnet, however some basic level of understanding is necessary for operating the CrossPoint 450 Plus or MAV Plus switcher via Telnet.

#### Open

Connect to the CrossPoint 450 Plus or MAV Plus switcher using the Open command. Once you are connected to the switcher, you can enter the SIS commands the same as you would if you were using the RS-232 link.

Connect to the CrossPoint 450 Plus or MAV Plus switcher as follows:

1. At the Telnet prompt, type *open {IP address}* and then press [Enter].  
**If the switcher is not password protected**, no further prompts are displayed until you break or disconnect the connection to the CrossPoint 450 Plus or MAV Plus switcher.

**If the switcher is password protected**, Telnet displays the password prompt.

2. If necessary, at the password prompt, type *{password}* and then press [Enter].

Connection to the switcher via the Ethernet can be password protected. There are two levels of password protection: administrator and user. A person logged on as an administrator has full access to all CrossPoint 450 Plus or MAV Plus switching capabilities and editing functions. Users can select video and/or audio for output, select test patterns, set RGB and audio mutes, select a blue screen, and view all settings with the exception of passwords. By default, the CrossPoint 450 Plus or MAV Plus switcher ships with both passwords set to {carriage return}.

Once you are logged in, the switcher returns either **Login Administrator** or **Login User**. No further prompts are displayed until you break or disconnect the connection to the CrossPoint 450 Plus or MAV Plus switcher.

#### Escape character and Esc key

When Telnet is first started, the utility advises that the **Escape character is 'Ctrl+]'**. Many SIS commands include the keyboard **Esc** key. Consequently, some confusion may exist between the Escape character and the Escape key.

The Telnet Escape character is a key combination, the **Ctrl** key and the **]** key pressed simultaneously, that returns you to the Telnet prompt while leaving the connection to the CrossPoint 450 Plus or MAV Plus switcher intact.

The Escape key is the **Esc** key on the computer keyboard.

---

### Local echo

Once connected to the CrossPoint 450 Plus or MAV Plus switcher, by default, Telnet does not display your keystrokes on the screen. SIS commands are typed in blindly and only the SIS responses are displayed on the screen. To command Telnet to show keystrokes, at the Telnet prompt, type *set local\_echo* and then press [Enter] before you open the connection to the switcher.

With local echo turned on, keystrokes and the switcher's responses are displayed on the same line. For example: **1\*1!In1 Out1 All**, where **1\*1!** is the SIS command and **In1 Out1 All** is the response.

With local echo turned on, all keystrokes are displayed, even those that should be masked, such as the password entry. For example, when entering a password with local echo turned on, you will see a display such as **a\*d\*m\*i\*n\***, where **admin** is the keyed in password and **\*\*\*\*\*** is the masked response.

Local echo can be turned off by typing *unset local\_echo* and then pressing [Enter] at the Telnet prompt. If you are connected to the CrossPoint 450 Plus or MAV Plus switcher and need to access the Telnet prompt to turn local echo off, type the Escape character (**Ctrl+Z**).

### Set carriage return-line feed

Unless commanded otherwise, Telnet transmits a line feed character only (no carriage return) to the connected switcher when you press the **Enter** key. This is the correct setting for SIS communication with the switcher. The Telnet *set crlf* command forces Telnet to transmit carriage return and line feed characters when **Enter** is pressed, but if *crlf* is set, the SIS link with the switcher will not function properly.

### Close

To close the link to the switcher, access the Telnet prompt by typing the Escape character (**Ctrl+Z**). At the Telnet prompt, type *close* and then press [Enter].

### Help

For Telnet command definitions, at the Telnet prompt, type *?* and then press [Enter].

### Quit

Exit the Telnet utility by typing *quit* and then press [Enter] at the Telnet prompt. If you are connected to the CrossPoint 450 Plus or MAV Plus switcher, access the Telnet prompt by typing the Escape character (**Ctrl+Z**).

# Ethernet Connection, cont'd

---

## Subnetting — A Primer

It is not the purpose of this manual to describe TCP/IP protocol in detail. However, some understanding of TCP/IP subnetting (a subnet is a **subset** of a **network** — a set of IP devices that have portions of their IP addresses in common) is necessary in order to understand the interaction of the CrossPoint 450 Plus or MAV Plus switcher and the mail server gateway. To understand subnetting at the level required to install and operate the CrossPoint 450 Plus or MAV Plus switcher, you must understand the concepts of a gateway, local and remote devices, IP addresses and octets, and subnet masks and octets.

### Gateways

The CrossPoint 450 Plus or MAV Plus switcher can communicate with the e-mail server that the switcher uses for e-mail notification directly (if they are on the same subnet) or the communication can be routed via a gateway (a computer that provides a link between different subnets).

### Local and remote devices

The local and remote devices are defined from the point of view of the function being described. In this manual, subnetting is an issue when you are using the controlling PC to set TCP/IP and e-mail values in the CrossPoint 450 Plus or MAV Plus switcher (see “IP Settings/Options window” in chapter 5, “Matrix Software” and “Email Settings page” in chapter 6, “HTML Operation”). When you are setting up the variables for e-mail notification, which may include subnetting, the matrix switcher is the local device and the e-mail server is the remote device.

### IP addresses and octets

Valid IP addresses consist of four 1-, 2-, or 3-digit numeric subfields, properly called octets, separated by dots (periods) (figure A-4). Each octet can be numbered from 000 through 255. Leading zeroes, up to 3 digits total per octet, are optional. Values of 256 and above are invalid.

Typical IP Address: 192,168,254,254  
Octets

**Figure A-4 — IP address and octets**

### Subnet masks and octets

The subnet mask (figure A-5) is used to determine whether the local and remote devices are on the same subnet or different subnets. The subnet mask consists of four numeric octets separated by dots. Each octet can be numbered from 000 through 255. Leading zeroes, up to 3 digits total per octet, are optional. Each octet typically contains either 255 or 0. The octets determine whether or not the same octets of two IP addresses will be compared when determining if two devices are on the same subnet.

255 indicates that this octet will be compared between two IP addresses.      0 indicates that this octet will **not** be compared between two IP addresses.  
Typical Subnet Mask: 255,255,0,0  
Octets

**Figure A-5 — Subnet mask and octets**

## Determining whether devices are on the same subnet

To determine the subnet, the local device's IP address is **compared** to the remote device's IP address (figure A-6). Each address's octets are **compared or not compared**, depending on the value in the related subnet mask octet.

- If a subnet mask octet contains the value 255, the related octets of the local device's address and the remote device's IP address are unmasked.

**Unmasked octets are compared** (indicated by ? in figure A-6).

- If the subnet mask octet contains the value 0, the related octets of the local device's and remote device's IP addresses are masked.

**Masked octets are not compared** (indicated by X in figure A-6).

If the unmasked octets of the two IP addresses **match** (indicated by = in figure A-6) (example 1), the two addresses **are on the same subnet**.

If the two unmasked fields **do not match** (indicated by ≠ in figure A-6) (example 2 and example 3), the addresses **are not on the same subnet**.

	<b>Example 1</b>	<b>Example 2</b>	<b>Example 3</b>
Local IP Address:	192.168.254.254	192.168.254.254	192.168.254.254
Subnet Mask:	255.255.0.0 (??.X.X)	255.255.0.0 (??.X.X)	255.255.0.0 (??.X.X)
Remote IP Address:	<u>192.168.2.25</u>	<u>190.190.2.25</u>	<u>192.190.2.25</u>
Match?:	<u>==.X.X — <b>Match</b></u> (Same subnet)	<u>≠.X.X — <b>No match</b></u> (Different subnet)	<u>≠.X.X — <b>No match</b></u> (Different subnet)

**Figure A-6 — Comparing the IP addresses**

## Ethernet Connection, cont'd

---

*This page was intentionally left blank.*



# CrossPoint 450 Plus and MAV Plus Switchers

# Appendix B

## Reference Information

CrossPoint 450 Plus Specifications

MAV Plus Specifications

Part Numbers

Button Labels



# Reference Information

---

## CrossPoint 450 Plus Specifications

### Video

#### Routing

84 Series .....	8 x 4 matrix
88 Series .....	8 x 8 matrix
816 Series .....	8 x 16 matrix
124 Series .....	12 x 4 matrix
128 Series .....	12 x 8 matrix
1212 Series .....	12 x 12 matrix
168 Series .....	16 x 8 matrix
1616 Series .....	16 x 16 matrix
2412 Series .....	24 x 12 matrix
2424 Series .....	24 x 24 matrix
3216 Series .....	32 x 16 matrix
3232 Series .....	32 x 32 matrix

Gain ..... Unity

Bandwidth ..... 450 MHz (-3 dB), fully loaded  
0 - 10 MHz: no more than +0.1 dB to -0.1 dB  
0 - 130 MHz: no more than +0.8 dB to -0.8 dB

Crosstalk ..... -80 dB @ 1 MHz, -55 dB @ 10 MHz, -45 dB @ 30 MHz, -37 dB @ 100 MHz

Switching speed ..... 200 ns (max.)

### Video input

Number/signal type ..... 8, 12, 16, 24, or 32 RGBHV, RGBS, RGsB, RsGsBs, HDTV, component video, S-video, composite video

#### Connectors

84/88/816 Series .....	8 x 5 BNC female
124/128/1212 Series .....	12 x 5 BNC female
168/1616 Series .....	16 x 5 BNC female
2412/2424 Series .....	24 x 5 BNC female
3216/3232 Series .....	32 x 5 BNC female

Nominal level ..... 1 Vp-p for Y of component video and S-video, and for composite video  
0.7 Vp-p for RGB and R-Y and B-Y of component video  
0.3 Vp-p for C of S-video

Minimum/maximum levels ..... Analog: 0.5 V to 2.0 Vp-p with no offset

Impedance ..... 75 ohms

Horizontal frequency ..... 15 kHz to 150 kHz

Vertical frequency ..... 30 Hz to 150 Hz

Return loss ..... <-30 dB @ 5 MHz

DC offset (max. allowable) ..... 1.5 V

### Video output

Number/signal type ..... 4, 8, 12, 16, 24, or 32 RGBHV, RGBS, RGsB, RsGsBs, HDTV, component video, S-video, composite video

---

## Connectors

84/124 Series .....	4 x 5 BNC female
88/128/168 Series .....	8 x 5 BNC female
1212/2412 Series .....	12 x 5 BNC female
816/1616/3216 Series .....	16 x 5 BNC female
2424 Series .....	24 x 5 BNC female
3232 Series .....	32 x 5 BNC female
Nominal level .....	1 Vp-p for Y of component video and S-video, and for composite video 0.7 Vp-p for RGB and R-Y and B-Y of component video 0.3 Vp-p for C of S-video
Minimum/maximum levels .....	0 V to 2.0 Vp-p (follows input)
Impedance .....	75 ohms
Return loss .....	-30 dB @ 5 MHz
DC offset .....	±5 mV with input at 0 offset
Switching type .....	Triple-Action™

## Sync

Input type .....	RGBHV, RGBS, RGsB, RsGsBs
Output type .....	RGBHV, RGBS, RGsB, RsGsBs (follows input)
Input level .....	0.5 V to 5.0 Vp-p, 4.0 Vp-p normal
Output level .....	AGC to TTL: 4.0 V to 5.0 Vp-p, unterminated
Input impedance .....	Inputs 1 to 4: 75 or 510 ohms, switchable Inputs 5 to 8, 12, or 16: 510 ohms
Output impedance .....	75 ohms
Max input voltage .....	5.0 Vp-p
Max. propagation delay .....	<120 ns
Max. rise/fall time .....	4 ns
Polarity .....	Positive or negative (follows input)

## Audio — audio models only

### Routing

84 Series .....	8 x 4 stereo matrix
88 Series .....	8 x 8 stereo matrix
816 Series .....	8 x 16 stereo matrix
124 Series .....	12 x 4 stereo matrix
128 Series .....	12 x 8 stereo matrix
1212 Series .....	12 x 12 stereo matrix
168 Series .....	16 x 8 stereo matrix
1616 Series .....	16 x 16 stereo matrix
2412 Series .....	24 x 12 stereo matrix
2424 Series .....	24 x 24 stereo matrix
3216 Series .....	32 x 16 stereo matrix
3232 Series .....	32 x 32 stereo matrix
Gain .....	Unbalanced output: -6 dB; balanced output 0 dB
Frequency response .....	20 Hz to 20 kHz, ±0.05 dB
THD + Noise .....	0.03% @ 1 kHz at nominal level
S/N .....	>90 dB, balanced, at maximum output (21 dBu), unweighted
Crosstalk .....	<-80 dB @ 1 kHz, fully loaded
Stereo channel separation .....	>80 dB @ 1 kHz
CMRR .....	>75 dB @ 20 Hz to 20 kHz

## Reference Information, cont'd

---

### Audio input — audio models only

Number/signal type .....	8, 12, 16, 24, or 32 stereo, balanced/unbalanced
Connectors .....	(8, 12, 16, 24, or 32) 3.5 mm captive screw connectors, 5 pole
Impedance .....	>10k ohm, balanced/unbalanced, DC coupled
Nominal level .....	0 dBu (775 mV)
Maximum level .....	+19.5 dBu, (balanced or unbalanced) at 0.01% THD+N
Input gain adjustment .....	-18 dB to +24 dB (default = 0 dB), adjustable per input by RS-232/422, Ethernet, or front panel

**NOTE**  $0 \text{ dBu} = 0.775 \text{ V}_{\text{rms}}$ ,  $0 \text{ dBV} = 1 \text{ V}_{\text{rms}}$ ,  $0 \text{ dBV} \approx 2 \text{ dBu}$

### Audio output — audio models only

Number/signal type .....	4, 8, 12, 16, 24, or 32 stereo, balanced/unbalanced
Connectors .....	(4, 8, 12, 16, 24, or 32) 3.5 mm captive screw connectors, 5 pole
Impedance .....	50 ohms unbalanced, 100 ohms balanced
Gain error .....	$\pm 0.1$ dB channel to channel
Maximum level (Hi-Z) .....	$>+21$ dBu, balanced or unbalanced at 0.10% THD+N
Maximum level (600 ohm) .....	$>+15$ dBm, balanced or unbalanced at 0.10% THD+N
Output volume range .....	0 to 64 (-75.8 dB to 0 dB) in 1 dB increments from steps 1 to 64, 12 dB increment from step 0 to 1; default = 64 = 0 dB

### Control/remote — switcher

Serial host control port	
2412, 2424, 3216, 3232 Series	1 RS-232 or RS-422, rear panel 9-pin female D connector
All other models .....	1 bidirectional RS-232 or RS-422, rear panel 9-pin female D connector 1 bidirectional RS-232, front panel 2.5 mm mini stereo jack
Baud rate and protocol .....	9600 (default), 19200, 38400, 115200 baud (adjustable); 8 data bits, 1 stop bit, no parity
Serial control pin configurations	
RS-232 .....	9-pin female D connector: 2 = TX, 3 = RX, 5 = GND Mini stereo jack: tip = TX, ring = RX, sleeve = GND
RS-422	
88, 816, 1212, 168, 1616 Series	9-pin female D connector: 2 = TX-, 3 = RX-, 5 = GND, 7 = RX+, 8 = Tx+
All other models .....	9-pin female D connector: 1 = TX+, 2 = TX-, 3 = Rx+, 4 = RX-, 5 = GND
Ethernet control port .....	1 RJ-45 female connector
Ethernet data rate .....	10/100Base-T, half/full duplex with autodetect
Ethernet protocol .....	ARP, DHCP, ICMP (ping), TCP/IP, Telnet, HTTP
Program control .....	Extron's control/configuration program for Windows® Extron's Simple Instruction Set (SIS™) Microsoft® Internet Explorer, Telnet

---

## General

Power (24- and 32-input models)	2 power supplies (1 primary, 1 redundant), 100 VAC to 240 VAC, 50/60 Hz, internal 2412/2424 Series: 150 watts 3216/3232 Series: 180 watts
Power (all other models) .....	100 VAC to 240 VAC, 50/60 Hz, internal 84/88/124/128 Series: 30 watts 816/1212/168/1616 Series: 36 watts
Temperature/humidity .....	Storage: -40 to +158 °F (-40 to +70 °C) / 10% to 90%, noncondensing Operating: +32 to +122 °F (0 to +50 °C) / 10% to 90%, noncondensing
Cooling	
84-1616 Series .....	Convection, unvented
2412-3232 Series .....	Forced air, right to left (as viewed from the front)
Rack mount .....	Yes
Enclosure type .....	Metal
Enclosure dimensions (Depth excludes connectors. Width excludes rack ears.)	
84/88/124/128 Series .....	5.25" H x 17.0" W x 9.4" D (3U high, full rack wide) 13.3 cm H x 43.2 cm W x 23.9 cm D
816/1212/168/1616 Series ..	10.5" H x 17.0" W x 9.7" D (6U high, full rack wide) 26.7 cm H x 43.2 cm W x 24.6 cm D
2412/3216 Series .....	14.0" H x 17.0" W x 12.0" D (8U high, full rack wide) (35.5 cm H x 43.2 cm W x 30.5 cm D)
2424/3232 Series .....	17.5" H x 17.0" W x 12.0" D (10U high, full rack wide) (44.5 cm H x 43.2 cm W x 30.5 cm D)
Product weight	
84/88/124/128 Series .....	14.4 lbs (6.5 kg)
816/1212/168/1616 Series ..	19.4 lbs (8.8 kg)
2412/3216 Series .....	39.0 lbs (17.7 kg)
2424/3232 Series .....	42.0 lbs (19.1 kg)
Shipping weight	
84/88/124/128 Series .....	21 lbs (10 kg)
816/1212/168/1616 Series .	26 lbs (12 kg)
2412/3216 Series .....	56 lbs (26 kg)
2424/3232 Series .....	60 lbs (28 kg)
DIM weight, international	
84/88/124/128 Series .....	25 lbs (12 kg)
816/1212/168/1616 Series .	34 lbs (15.5 kg)
2412/2424/3216/3232 Series	89 lbs (41 kg)
Vibration .....	ISTA 1A in carton (International Safe Transit Association)
Listings .....	UL, CUL
Compliances .....	CE, FCC Class A, VCCI, AS/NZS, ICES
MTBF .....	30,000 hours
Warranty .....	3 years parts and labor

**NOTE** All nominal levels are at  $\pm 10\%$ .

**NOTE** Specifications are subject to change without notice.

# Reference Information, cont'd

---

## MAV Plus Specifications

### Video — video models

#### Routing

88 Series .....	8 x 8 matrix
816 Series .....	8 x 16 matrix
128 Series .....	12 x 8 matrix
1212 Series .....	12 x 12 matrix
168 Series .....	16 x 8 matrix
1616 Series .....	16 x 16 matrix
2412 Series .....	24 x 12 matrix
2424 Series .....	24 x 24 matrix
3216 Series .....	32 x 16 matrix
3232 Series .....	32 x 32 matrix

Gain ..... Unity

Bandwidth ..... 150 MHz (-3 dB), fully loaded  
0 - 10 MHz: no more than +0.1 dB to -0.1 dB  
0 - 30 MHz: no more than +0.1 dB to -0.5 dB

Phase between I/Os (2412/2424/3216/3232 Series)  
<1.28° at 3.58 MHz

Differential phase error ..... 1.0° at 3.58 MHz and 4.43 MHz

Differential gain error ..... 1.0% at 3.58 MHz and 4.43 MHz

Crosstalk ..... -50 dB @ 5 MHz

Switching speed ..... 200 ns (max.)

### Video input — video models

#### Number/signal type

88/816 Series .....	8 RGsB, RsGsBs, HDTV, component video, S-video, composite video
128 Series .....	12 RGsB, RsGsBs, HDTV, component video, S-video, composite video
168/1616 Series .....	16 RGsB, RsGsBs, HDTV, component video, S-video, composite video
1212 Series composite video models	12 composite video
2412/2424 Series composite video models	24 composite video
2412/2424 Series S-video models	24 S-video, composite video

---

3216/3232 Series composite video models	32 composite video
3216/3232 Series S-video models	32 S-video, composite video
<b>Connectors</b>	
88/816 Series .....	8 x 3 BNC female for RGB/HDTV/component video, 8 x 2 BNC female for S-video, 8 BNC female for composite video
128 Series .....	12 x 3 BNC female for RGB/HDTV/component video, 12 x 2 BNC female for S-video, 12 BNC female for composite video
168/1616 Series .....	16 x 3 BNC female for RGB/HDTV/component video, 16 x 2 BNC female for S-video, 16 BNC female for composite video
1212 Series composite video models	12 BNC female
2412/2424 Series composite video models	24 BNC female
2412/2424 Series S-video models	24 x 2 BNC female
3216/3232 Series composite video models	32 BNC female
3216/3232 Series S-video models	32 x 2 BNC female
Nominal level .....	1 Vp-p for Y of component video and S-video, and for composite video 0.7 Vp-p for RGB and for R-Y and B-Y of component video 0.3 Vp-p for C of S-video
Minimum/maximum levels .....	Analog: 0.5 V to 2.0 Vp-p with no offset
Impedance .....	75 ohms
Return loss .....	<-30 dB @ 5 MHz
DC offset (max. allowable) .....	1.5 V
External sync (genlock) .....	0.3 V to 0.4 Vp-p

### Video output — video models

<b>Number/signal type</b>	
1212/2412/2424/3216/3232 Series composite video models	12, 16, 24, or 32 composite video
1212/2412/2424/3216/3232 Series S-video models	12, 16, 24, or 32 S-video
All other models .....	8 or 16 RGsB, RsGsBs, HDTV, component video, S-video, composite video (follows input type)
<b>Connectors</b>	
128/168 Series .....	8 x 3 BNC female for RGB/HDTV/component video, 8 x 2 BNC female for S-video, 8 BNC female for composite video
1212/2412 Series composite video models	12 BNC female for composite video
1212/2412 Series S-video models	12 BNC female for composite video <i>or</i> 24 BNC female for S-video
816/1616/3216 Series .....	16 x 3 BNC female for RGB/HDTV/component video, or 16 x 2 BNC female for S-video, or 16 BNC female for composite video
2424 Series .....	24 BNC female for composite video <i>or</i> 48 BNC female for S-video
3232 Series .....	32 BNC female for composite video <i>or</i> 64 BNC female for S-video

## Reference Information, cont'd

---

Nominal level .....	1 Vp-p for Y of component video and S-video, and for composite video 0.7 Vp-p for RGB and for R-Y and B-Y of component video 0.3 Vp-p for C of S-video
Minimum/maximum levels .....	0.5 V to 2.0 Vp-p (follows input)
Impedance .....	75 ohms
Return loss .....	<-30 dB @ 5 MHz
DC offset .....	±5 mV with input at 0 offset
Switching type .....	Vertical interval

### Sync — MAV Plus 88/128/1212/168/816/1616 video models

Genlock connectors .....	1 BNC female
Standards .....	NTSC 3.58, NTSC 4.43, PAL, SECAM

### Sync — MAV Plus 2412/2424/3216/3232 video models

Standards .....	NTSC 3.58, NTSC 4.43, PAL, SECAM
-----------------	----------------------------------

### Audio — audio models

#### Routing

88 Series .....	8 x 8 stereo matrix
816 Series .....	8 x 16 stereo matrix
128 Series .....	12 x 8 stereo matrix
164 Series .....	16 x 4 stereo matrix
168 Series .....	16 x 8 stereo matrix
1616 Series .....	16 x 16 stereo matrix
2412 Series .....	24 x 12 stereo matrix
2424 Series .....	24 x 24 stereo matrix
3216 Series .....	32 x 16 stereo matrix
3232 Series .....	32 x 32 stereo matrix

#### Gain

MAV Plus 128 AV RCA .....	Unbalanced output: 0 dB
All other models .....	Unbalanced output: -6 dB; balanced output 0 dB
Frequency response .....	20 Hz to 20 kHz, ±0.05 dB
THD + Noise .....	0.03% @ 1 kHz at nominal level
S/N .....	>90 dB, balanced, at maximum output (21 dBu), unweighted
Crosstalk .....	<-80 dB @ 1 kHz, fully loaded
Stereo channel separation .....	>80 dB @ 1 kHz
CMRR .....	>75 dB @ 20 Hz to 20 kHz

### Audio input — audio models

#### Number/signal type

MAV Plus 128 AV RCA .....	12 stereo, unbalanced
All other models .....	8, 12, 16, 24, or 32 stereo, balanced/unbalanced

#### Connectors

MAV Plus 128 AV RCA .....	12 pairs of RCA connectors
All other models .....	(8, 12, 16, 24, or 32) 3.5 mm captive screw connectors, 5 pole

Impedance .....	>10k ohm, balanced/unbalanced, DC coupled
-----------------	---

#### Nominal level

MAV Plus 2412/2424/3216/3232 Series	-10 dBV (316 mV)
All other models .....	0.1 dBu (775 mV)
Maximum level .....	+19.5 dBu, (balanced or unbalanced) at 1% THD+N

---

Input gain adjustment ..... -18 dB to +24 dB (default = 0 dB), adjustable per input by RS-232/422 or front panel or by Ethernet

**NOTE** 0 dBu = 0.775 Vrms, 0 dBV = 1 Vrms, 0 dBV ≈ 2 dBu

### Audio output — audio models

Number/signal type  
MAV Plus 128 AV RCA ..... 8 stereo, unbalanced  
All other models ..... 4, 8, 12, 16, 24, or 32 stereo, balanced/unbalanced

Connectors  
MAV Plus 128 AV RCA ..... 8 pairs of RCA connectors  
All other models ..... (4, 8, 12, 16, 24, or 32) 3.5 mm captive screw connectors, 5 pole

Impedance ..... 50 ohms unbalanced, 100 ohms balanced

Gain error ..... ±0.1 dB channel to channel

Maximum level (Hi-Z) ..... >+21 dBu, balanced or unbalanced at 0.10% THD+N

Maximum level (600 ohm) ..... >+15 dBm, balanced or unbalanced at 0.10% THD+N

Output volume range ..... 0 to 64 (-75.8 dB to 0 dB) in 1 dB increments from steps 1 to 64, 12 dB increment from step 0 to 1; default = 64 = 0 dB

### Control/remote — switcher

Serial host control port  
2412/2424/3216/3232 Series  
1 RS-232 or RS-422, rear panel 9-pin female D connector  
All other models ..... 1 bidirectional RS-232 or RS-422, rear panel 9-pin female D connector  
1 bidirectional RS-232, front panel 2.5 mm mini stereo jack

Baud rate and protocol ..... 9600 (default), 19200, 38400, 115200 baud (adjustable); 8 data bits, 1 stop bit, no parity

Serial control pin configurations  
88/816/164/168/1212/1616 Series  
RS-232 ..... 9-pin female D connector: 2 = TX, 3 = RX, 5 = GND  
Mini stereo jack: tip = TX, ring = RX, sleeve = GND  
RS-422 ..... 2 = TX-, 3 = RX-, 5 = GND, 7 = RX+, 8 = Tx+

2412, 2424, 3216, 3232 Series  
RS-232 ..... 9-pin female D connector: 2 = TX, 3 = RX, 5 = GND  
RS-422 ..... 1 = Tx+, 2 = Tx-, 3 = Rx+, 4 = Rx-, 5 = Gnd

Ethernet control port ..... 1 RJ-45 female connector

Ethernet data rate ..... 10/100Base-T, half/full duplex with autodetect

Ethernet protocol ..... ARP, DHCP, ICMP (ping), TCP/IP, Telnet, HTTP, SMTP

Program control ..... Extron's control/configuration program for Windows®  
Extron's Simple Instruction Set (SIS™)  
Microsoft® Internet Explorer, Telnet

### General

Power ..... 100 VAC to 240 VAC, 50/60 Hz, internal

88/128 Series ..... 20 watts

816/1212/164/168/1616 Series  
30 watts

2412/3216 Series video models  
2 (primary and redundant), 100 watts

2424/3232 Series video models: 2 (primary and redundant), 120 watts



## Reference Information, cont'd

---

Temperature/humidity ..... Storage: -40 to +158 °F (-40 to +70 °C) / 10% to 90%, noncondensing  
Operating: +32 to +113 °F (0 to +45 °C) / 10% to 90%, noncondensing

### Cooling

MAV Plus 88-1616 ..... Convection, unvented  
MAV Plus 2412 3232 ..... Forced air, right to left (viewed from the front panel)

Rack mount ..... Yes

Enclosure type ..... Metal

Enclosure dimensions (Depth excludes connectors and controls. Width excludes rack ears.)

88/128 Series (all) and 816/1212/164/168/1616 Composite Video Series and/or Stereo Audio Series  
3.5" H x 17.0" W x 9.4" D (2U high, full rack wide)  
8.9 cm H x 43.2 cm W x 23.9 cm D

816/1212/168/1616 S-video Series with and without audio  
5.25" H x 17.0" W x 9.4" D (3U high, full rack wide)  
13.3 cm H x 43.2 cm W x 23.9 cm D

816/168/1616 Component Video Series with and without audio  
7.0" H x 17.0" W x 9.7" D (4U high, full rack wide)  
17.8 cm H x 43.2 cm W x 24.6 cm D

2412/2424/3216/3232 Composite Video Series and S-video Series  
8.75" H x 17.0" W x 12.25" D (5U high, full rack wide)  
22.2 cm H x 43.2 cm W x 31.1 cm D

3232 S-Video with Audio Series  
14.0" H x 17.0" W x 12.25" D (8U high, full rack wide)  
35.6 cm H x 43.2 cm W x 31.1 cm D

### Product weight/shipping weight

88/128 Composite Video Series with and without audio (2U enclosures)  
8.9 lbs (4.0 kg)/15 lbs (7 kg)

816/1212/164/168/1616 Composite Video Series and Stereo Audio Series (2U enclosures)  
9.4 lbs (4.3 kg)/15 lbs (7 kg)

816/1212/168/1616 S-video Series with and without audio (3U enclosures)  
11.9 lbs (5.4 kg)/18 lbs (9 kg)

816/168/1616 Component Video Series with and without audio (4U enclosures)  
14.4 lbs (6.5 kg)/22 lbs (10 kg)

2412 Series ..... 18.4 lbs (8.3 kg)/28 lbs (13 kg)

3216 Series ..... 18.9 lbs (8.6 kg)/28 lbs (13 kg)

2424 Series ..... 19.1 lbs (8.7 kg)/29 lbs (14 kg)

3232 Series ..... 19.8 lbs (9.0 kg)/29 lbs (14 kg)

### DIM weight (2U, 3U, and 4U models)

International ..... 25 lbs (12 kg)

Vibration ..... ISTA 1A in carton (International Safe Transit Association)

Listings ..... UL, CUL

Compliances ..... CE, FCC Class A, VCCI, AS/NZS, ICES

MTBF ..... 30,000 hours

Warranty ..... 3 years parts and labor

**NOTE** All nominal levels are at  $\pm 10\%$ .

**NOTE** Specifications are subject to change without notice.

---

## Part Numbers

### CrossPoint 450 Plus part numbers

Model	Part #
CrossPoint 450 Plus 84 HV	60-337-12
CrossPoint 450 Plus 84 HVA	60-337-11
CrossPoint 450 Plus 88 HV	60-336-12
CrossPoint 450 Plus 88 HVA	60-336-11
CrossPoint 450 Plus 124 HV	60-335-12
CrossPoint 450 Plus 124 HVA	60-335-11
CrossPoint 450 Plus 128 HV	60-334-12
CrossPoint 450 Plus 128 HVA	60-334-11
CrossPoint 450 Plus 816 HV	60-395-12
CrossPoint 450 Plus 816 HVA	60-395-11
CrossPoint 450 Plus 168 HV	60-333-12
CrossPoint 450 Plus 168 HVA	60-333-11
CrossPoint 450 Plus 1212 HV	60-852-12
CrossPoint 450 Plus 1212 HVA	60-852-11
CrossPoint 450 Plus 1616 HV	60-332-12
CrossPoint 450 Plus 1616 HVA	60-332-11
CrossPoint 450 Plus 2412HV	60-470-02
CrossPoint 450 Plus 2412HVA	60-470-01
CrossPoint 450 Plus 2424HV	60-468-02
CrossPoint 450 Plus 2424HVA	60-468-01
CrossPoint 450 Plus 3216HV	60-471-02
CrossPoint 450 Plus 3216HVA	60-471-01
CrossPoint 450 Plus 3232HV	60-469-02
CrossPoint 450 Plus 3232HVA	60-469-01

### MAV Plus part numbers

Model	Part #
MAV Plus 84 HD component/HDTV video	60-658DZ
MAV Plus 84 HDA component/HDTV video and audio	60-658DY
MAV Plus 84 SV S-video	60-685CZ
MAV Plus 84 SVA S-video and audio	60-658CY
MAV Plus 84 V composite video	60-658BZ
MAV Plus 84 AV composite video and audio	60-658BY
MAV Plus 84 A audio	60-658AY
MAV Plus 88 HD component/HDTV video	60-658GZ
MAV Plus 88 HDA component/HDTV video and audio	60-658GX
MAV Plus 88 SV S-video	60-658FZ
MAV Plus 88 SVA S-video and audio	60-658FX
MAV Plus 88 V composite video	60-658EZ
MAV Plus 88 AV composite video and audio	60-658EX
MAV Plus 88 A audio	60-658AX

## Reference Information, cont'd

<b>Model (continued)</b>	<b>Part #</b>
MAV Plus 124 HD component/HDTV video	60-658JZ
MAV Plus 124 HDA component/HDTV video and audio	60-658JW
MAV Plus 124 SV S-video	60-658IZ
MAV Plus 124 SVA S-video and audio	60-658IW
MAV Plus 124 V composite video	60-658HZ
MAV Plus 124 AV composite video and audio	60-658HW
MAV Plus 124 A audio	60-658AW
MAV Plus 128 HD component/HDTV video	60-658MZ
MAV Plus 128 HDA component/HDTV video and audio	60-658MV
MAV Plus 128 SV S-video	60-658LZ
MAV Plus 128 SVA S-video and audio	60-658LV
MAV Plus 128 V composite video	60-658KZ
MAV Plus 128 AV composite video and audio	60-658KV
MAV Plus 128 A audio	60-658AV
MAV Plus 128 AV RCA	60-238-14
MAV Plus 816 HD component/HDTV video	60-661-12
MAV Plus 816 HDA component/HDTV video and audio	60-661-11
MAV Plus 816 SV S-video	60-660-12
MAV Plus 816 SVA S-video and audio	60-660-11
MAV Plus 816 V composite video	60-659-12
MAV Plus 816 AV composite video and audio	60-659-11
MAV Plus 816 A audio	60-662-13
MAV Plus 164 A audio	60-854-13
MAV Plus 168 HD component/HDTV video	60-366-12
MAV Plus 168 HDA component/HDTV video and audio	60-366-11
MAV Plus 168 SV S-video	60-364-12
MAV Plus 168 SVA S-video and audio	60-364-11
MAV Plus 168 V composite video	60-329-12
MAV Plus 168 AV composite video and audio	60-329-11
MAV Plus 168 A audio	60-329-13
MAV Plus 1212 SV S-video	60-853-22
MAV Plus 1212 SVA S-video and audio	60-853-21
MAV Plus 1212 V composite video	60-853-12
MAV Plus 1212 AV composite video and audio	60-853-11
MAV Plus 1616 HD component/HDTV video	60-367-12
MAV Plus 1616 HDA component/HDTV video and audio	60-367-11
MAV Plus 1616 SV S-video	60-365-12
MAV Plus 1616 SVA S-video and audio	60-365-11
MAV Plus 1616 V composite video	60-240-12
MAV Plus 1616 AV composite video and audio	60-240-11
MAV Plus 1616 A audio	60-240-13
MAV Plus 2412 SV S-video	60-474-22
MAV Plus 2412 SVA S-video and audio	60-474-21
MAV Plus 2412 V composite video	60-474-02
MAV Plus 2412 AV composite video and audio	60-474-01
MAV Plus 2412 A audio	60-474-03

<b>Model (continued)</b>	<b>Part #</b>
MAV Plus 2424 SV S-video	60-472-22
MAV Plus 2424 SVA S-video and audio	60-472-21
MAV Plus 2424 V composite video	60-472-02
MAV Plus 2424 AV composite video and audio	60-472-01
MAV Plus 2424 A audio	60-472-03
MAV Plus 3216 SV S-video	60-475-22
MAV Plus 3216 SVA S-video and audio	60-475-21
MAV Plus 3216 V composite video	60-475-02
MAV Plus 3216 AV composite video and audio	60-475-01
MAV Plus 3216 A audio	60-475-03
MAV Plus 3232 SV S-video	60-473-22
MAV Plus 3232 SVA S-video and audio	60-473-21
MAV Plus 3232 V composite video	60-473-02
MAV Plus 3232 AV composite video and audio	60-473-01
MAV Plus 3232 A audio	60-473-03

### Included parts

<b>Part</b>	<b>Part #</b>
Captive screw audio connectors (audio models only)	
Extron Software Products CD	
CrossPoint 450 Plus/MAV Plus Matrix Switchers User's Manual	

### Replacement parts

<b>Replacement parts</b>	<b>Part #</b>
Button and cap diffuser kit	70-352-01
Button overlays	100-196-01
Captive screw audio connectors (qty. 10)	100-457-01

### Optional accessories

<b>Accessory</b>	<b>Part #</b>
MKP 3000	
Black	60-708-02
White	60-708-03
RAL 9010 white	60-708-05
MAAP, black	60-709-02
MAAP, white	60-709-03
MAAP, RAL 9010 white	60-709-05
MKP 10 MAAP	
Black	60-710-10
White	60-710-20
RAL 9010 white	60-710-50
MKP 2000	
Black	60-682-02
White	60-682-03
RAL 9010 white	60-682-05
MKP 1000	
Gray	60-239-01
Black	60-239-02
White	60-239-03
MCP 1000M (master)	60-298-01
MCP 1000S (slave)	60-298-02
Captive screw audio connectors	10-703-12
RCA-to-BNC adapter	10-264-01
SVHS - BNC adapter	26-353-01

## Reference Information, cont'd

---

### Cables

When using signals with a scanning frequency of 15-125 kHz and running distances of 100 feet or more, use high resolution BNC cables to achieve maximum performance.

#### Bulk cable

<b>RG6/super high resolution cable</b>	<b>Part #</b>
RG6/SHR-1 bulk , 500'	22-098-02
RG6/SHR-1 bulk , 1000'	22-098-03
RG6/SHR-4 bulk , 500'	22-099-02
RG6/SHR-5 bulk , 500'	22-100-02
RG6/SHR male crimp connectors, qty. 50	100-075-51
<b>RG59/High Resolution Cable</b>	<b>Part #</b>
RG59/HR-1 bulk , 500'	22-145-02
RG59/HR-1 bulk , 1000'	22-145-03
RG59/HR-1 plenum, bulk , 500'	22-146-02
RG59/HR-1 plenum, bulk , 1000'	22-146-03
RG59/HR male crimp connectors, qty. 50	100-075-51
<b>BNC-4 Mini HR Cable</b>	<b>Part #</b>
BNC-4 Mini HR bulk, 500'	22-032-02
BNC-4 Mini HR bulk, 1000'	22-032-03
<b>BNC-5 Mini HR Cable</b>	<b>Part #</b>
BNC-5 Mini HR bulk, 500'	22-020-02
BNC-5 Mini HR bulk, 1000'	22-020-03
<b>Plenum BNC-5 Mini HR Cable</b>	<b>Part #</b>
Plenum BNC-5 Mini HR bulk, 500'	22-103-02
Plenum BNC-5 Mini HR bulk, 1000'	22-103-03

#### Assorted connectors

<b>BNC connectors</b>	<b>Part #</b>
BNC Mini HR crimp connectors, qty. 50	100-074-51
SHRmale crimp connectors, qty. 50	100-075-51
BNC bulkhead connectors, qty. 50 (for custom wall plates)	100-076-51

#### Pre-cut cables

BNC-4 Mini HR cable is used for RGBS cable runs, and BNC-5 Mini HR cable is used for RGBHV cable runs. Either type can also be used for composite video, S-video, or RGsB. All Extron BNC cables have male connectors on both ends. A plenum version of the BNC-5 Mini HR cable is also available.

<b>BNC-4 Mini HR Cable</b>	<b>Part #</b>
BNC-4-25' MHR (25 feet/7.5 meters)	26-210-04
BNC-4-50' MHR (50 feet/15.0 meters)	26-210-05
BNC-4-75' MHR (75 feet/23.0 meters)	26-210-06
BNC-4-100' MHR (100 feet/30.0 meters)	26-210-07
BNC-4-150' MHR (150 feet/45.0 meters)	26-210-08
BNC-4-200' MHR (200 feet/60.0 meters)	26-210-09
BNC-4-250' MHR (250 feet/75.0 meters)	26-210-54
BNC-4-300' MHR (300 feet/90.0 meters)	26-210-53
BNC-5-25' MHR (25 feet/7.5 meters)	26-260-03

BNC-5 Mini HR Cable	Part #
BNC-5-50' MHR (50 feet/15.0 meters)	26-260-04
BNC-5-75' MHR (75 feet/23.0 meters)	26-260-16
BNC-5-100' MHR (100 feet/30.0 meters)	26-260-05
BNC-5-150' MHR (150 feet/45.0 meters)	26-260-12
BNC-5-200' MHR (200 feet/60.0 meters)	26-260-06
BNC-5-250' MHR (250 feet/75.0 meters)	26-260-18
BNC-5-300' MHR (300 feet/90.0 meters)	26-260-14

**NOTE** Bulk cable in lengths up to 5000' (1524 meter) rolls is available with or without connectors.

## Button Labels

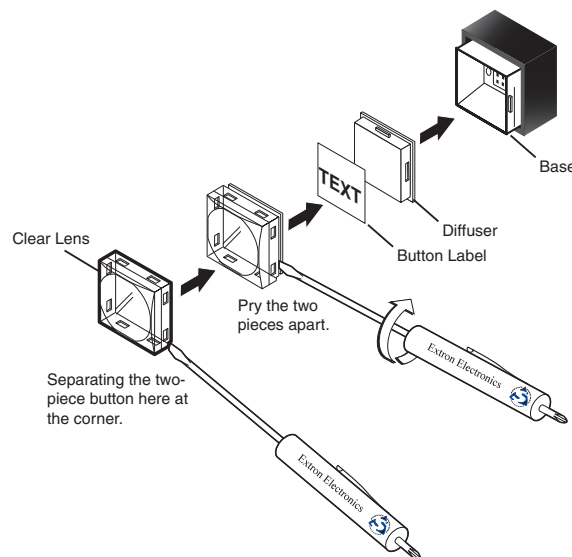
Page B-17 provides strips of blank button labels. If desired, copy them or cut them out, write button information in each button area as desired, and put them in the switcher's input or output buttons' windows. You can also create labels using the Button-Label Generator software (see chapter 5, "Matrix Software").

### Installing labels in the matrix switcher's buttons

Install new labels in the matrix switcher's front panel buttons as follows:

1. Make new labels using either the blanks on page B-17 or the Button-Label Generator software. Cut them out.
2. Remove the button from the switcher by grasping the button firmly and pulling it away from the front panel (figure B-1).

**NOTE** There are different button models available. Your buttons *may* appear different.



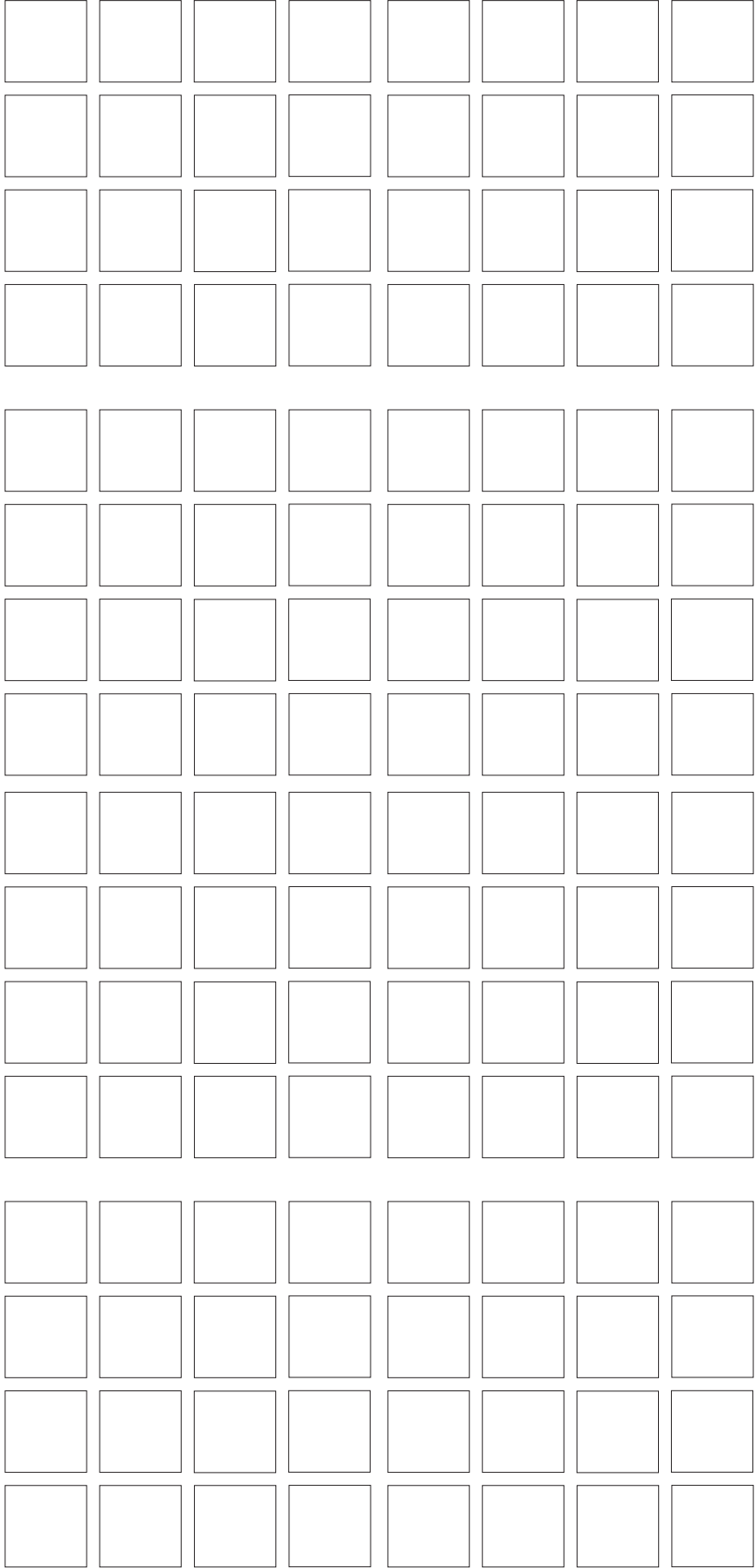
**Figure B-1 — Illuminated button label replacement**

3. Use a small screwdriver or Extron Tweezer to gently lever the button cap off of the white backing plate.
4. Insert a button label into the cap and gently but firmly press the cap onto the white backing plate.
5. Press the button into place in the matrix switcher.

## Reference Information, cont'd

---

*This page was intentionally left blank.*



**Button label blanks**



## Reference Information, cont'd

---

*This page was intentionally left blank.*

# Extron's Warranty

Extron Electronics warrants this product against defects in materials and workmanship for a period of three years from the date of purchase. In the event of malfunction during the warranty period attributable directly to faulty workmanship and/or materials, Extron Electronics will, at its option, repair or replace said products or components, to whatever extent it shall deem necessary to restore said product to proper operating condition, provided that it is returned within the warranty period, with proof of purchase and description of malfunction to:

**USA, Canada, South America,  
and Central America:**

Extron Electronics  
1001 East Ball Road  
Anaheim, CA 92805, USA

**Asia:**

Extron Electronics, Asia  
135 Joo Seng Road, #04-01  
PM Industrial Bldg.  
Singapore 368363

**Europe, Africa, and the Middle East:**

Extron Electronics, Europe  
Beeldschemweg 6C  
3821 AH Amersfoort  
The Netherlands

**Japan:**

Extron Electronics, Japan  
Kyodo Building  
16 Ichibancho  
Chiyoda-ku, Tokyo 102-0082  
Japan

This Limited Warranty does not apply if the fault has been caused by misuse, improper handling care, electrical or mechanical abuse, abnormal operating conditions or non-Extron authorized modification to the product.

*If it has been determined that the product is defective, please call Extron and ask for an Applications Engineer at (714) 491-1500 (USA), 31.33.453.4040 (Europe), 65.383.4400 (Asia), or 81.3.3511.7655 (Japan) to receive an RA# (Return Authorization number). This will begin the repair process as quickly as possible.*

Units must be returned insured, with shipping charges prepaid. If not insured, you assume the risk of loss or damage during shipment. Returned units must include the serial number and a description of the problem, as well as the name of the person to contact in case there are any questions.

Extron Electronics makes no further warranties either expressed or implied with respect to the product and its quality, performance, merchantability, or fitness for any particular use. In no event will Extron Electronics be liable for direct, indirect, or consequential damages resulting from any defect in this product even if Extron Electronics has been advised of such damage.

Please note that laws vary from state to state and country to country, and that some provisions of this warranty may not apply to you.



[www.extron.com](http://www.extron.com)

**Extron Electronics, USA**  
1230 South Lewis Street  
Anaheim, CA 92805  
800.633.9876 714.491.1500  
FAX 714.491.1517

**Extron Electronics, Europe**  
Beeldschermweg 6C  
3821 AH Amersfoort, The Netherlands  
+800.3987.6673 +31.33.453.4040  
FAX +31.33.453.4050

**Extron Electronics, Asia**  
135 Joo Seng Rd. #04-01  
PM Industrial Bldg., Singapore 368363  
+800.7339.8766 +65.6383.4400  
FAX +65.6383.4664

**Extron Electronics, Japan**  
Kyodo Building, 16 Ichibancho  
Chiyoda-ku, Tokyo 102-0082  
Japan  
+81.3.3511.7655 FAX +81.3.3511.765