

SERVICE MANUAL

MB-4

CONTENTS

Replacing the Spool Stand	4
Replacing the Tension Unit Cover	4
Replacing the Static head cover (Right)	5
To Replace Right Cover and Left Cover	6
Replacing the Base Cover and Bed Cover	7
Checking the Thread Paths (1)	8
Checking the Thread Paths (2)	9
Replacing the Needle	10
Needle and Thread Reference Table	11
Checking the Lowest Position of the Needle	12
Replacing the Needle Bar Rest	13
Replacing the Take-up Lever Cam Roller	14
Adjusting the Take up Lever Timing	15
Replacing and Adjusting the Presser Foot (1)	16
Replacing and Adjusting the Presser Foot (2)	17
Replacing the Thread Catcher Unit	18
Replacing the Thread Catcher Hook	19
Replacing the Jump Solenoid	20

CONTENTS

Adjusting a Play in the Moving Head	21
Replacing the Moving Head (1)	22
Replacing the Moving Head (2)	23
Adjusting the Needle Drop Position (Back or Forth)	24
Adjusting the Needle Height	25
Replacing the Needle Bar, Needle Spring and Cushion	26
Replacing the Rotation Stopper Plate	27
Replacing the Thread Take-up Lever	28
Adjusting the Check Spring Tension	29
Adjusting the Check Spring Stroke	30
Adjusting the Thread Catcher Holder	31
Replacing the Thread Catcher Loop Tape	32
Replacing the Lateral Moving Unit	33
Adjust the Hook Timing	34
Adjusting the Position of the Hook Stopper	35
Replacing the Thread Cutter Driving Roller	36
Replacing the Dynamic Cutter Blade	37
Replacing the Static Cutter Blade	38

CONTENTS

- Adjusting the Static Cutter Blade 39
- Adjusting the Dynamic Cutter Blade 40
- Adjusting the Bobbin Thread Holder 41
- Adjusting the Thread Keeper 42
- Adjusting the X-carriage Belt Tension 43
- Replacing the X-carriage Belt 44
- Adjusting the Y-carriage Belt Tension 45
- Replacing the Y-carriage Belt 46
- Adjusting the Timing Belt Tension 47
- Replacing the Timing Belt 48
- Adjusting the Motor Belt Tension 49
- Replacing the Motor Belt 50
- Replacing the DC Motor 51
- Adjusting the Needle Upper Shaft Timing 52
- Adjusting the Moving Head Stop Position 53
- Adjusting the Needle Stop Position 54
- Adjusting the Carriage Home Position (1) 55
- Adjusting the Carriage Home Position (2) 56
- Parts List 57-100

Replacing the Spool Stand

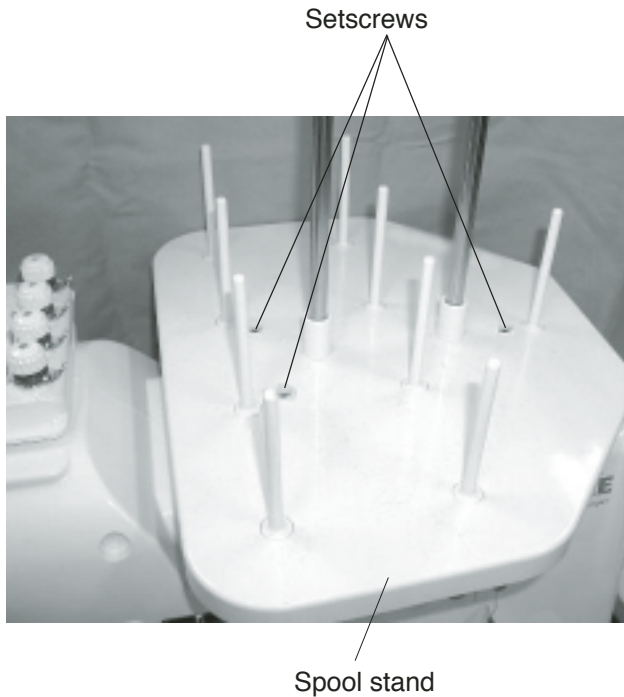
**To remove:**

1. Remove the 3 setscrews and spool stand.

To attach:

2. Attach the spool stand and tighten the 3 setscrews.

Replacing the Tension Unit Cover

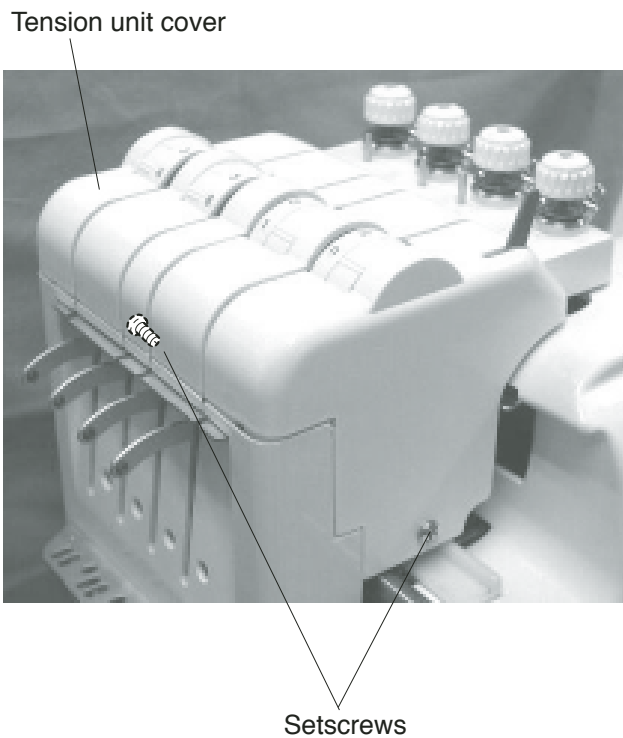
**To remove:**

1. Remove the 2 setscrews and tension unit cover.

To attach:

2. Attach the tension unit cover and tighten the 2 setscrews.

Replacing the Static Head Cover (Right)

Caps, Setscrews (A)

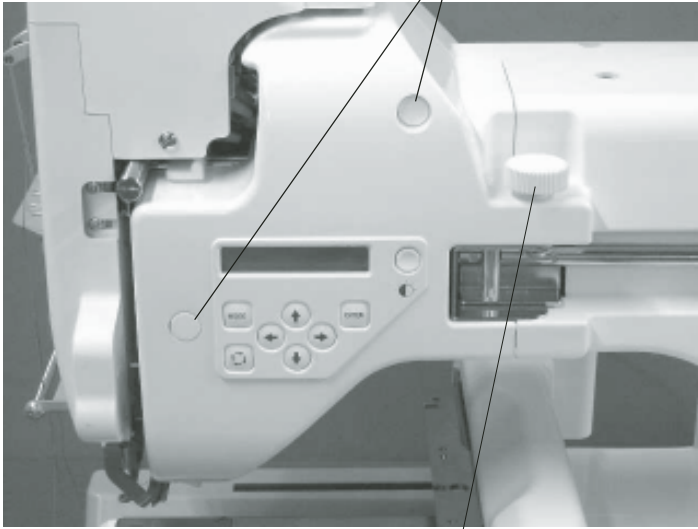

RCS mounting arm knob

To remove:

1. Loosen the RCS mounting arm knob and remove it.
2. Remove 2 caps, and 2 setscrews (A). Remove the static head cover (right).
3. Disconnect the LED lamp connector and K-board connector.

To attach:

4. Connect the LED lamp connector and K-board connector.
5. Attach the static head cover (right) with the 2 setscrews (A). Attach the 2 caps.
6. Attach the RCS mounting arm knob.



LED lamp connector

Hooks

K-board connector

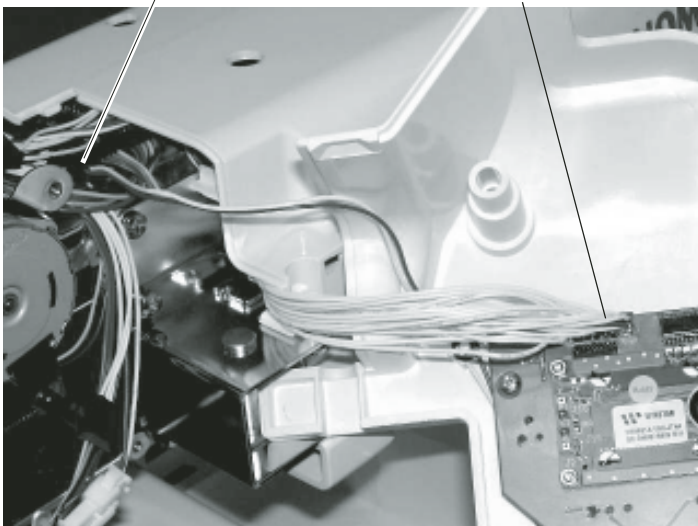

To Replace Right Cover and Left Cover

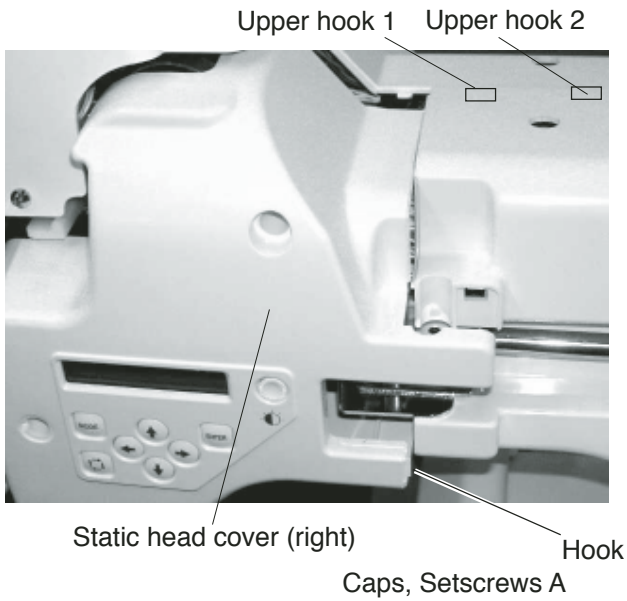

Right Cover

To remove:

1. Remove the static head cover (right).
Unhook the right cover from the right hook.
 - To remove the static head cover (right), Unhook the cover from upper hook 1, upper hook 2 and the hook on handwheel side.
2. Remove 3 caps and 3 setscrews A.
Remove the right cover.

To attach:

3. Attach the right cover with 3 setscrews A and 3 caps.
4. Attach the static head cover (right).
 - Do not get cords caught when attaching the static head cover (right).



Caps, Setscrews B

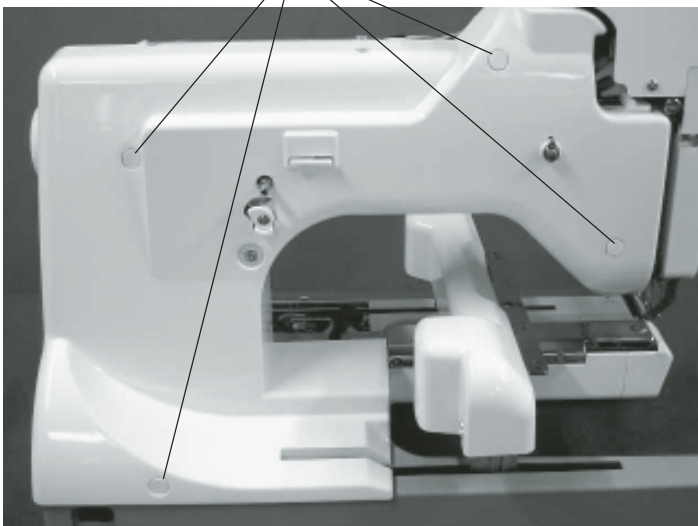

Left Cover

To remove:

1. Remove 4 caps and 4 setscrews B.
Remove the left cover.
Disconnect the connectors.

To attach:

2. Connect the connectors.
Attach the left cover with 4 setscrews B and 4 caps.

Replacing the Base Cover and Bed Cover

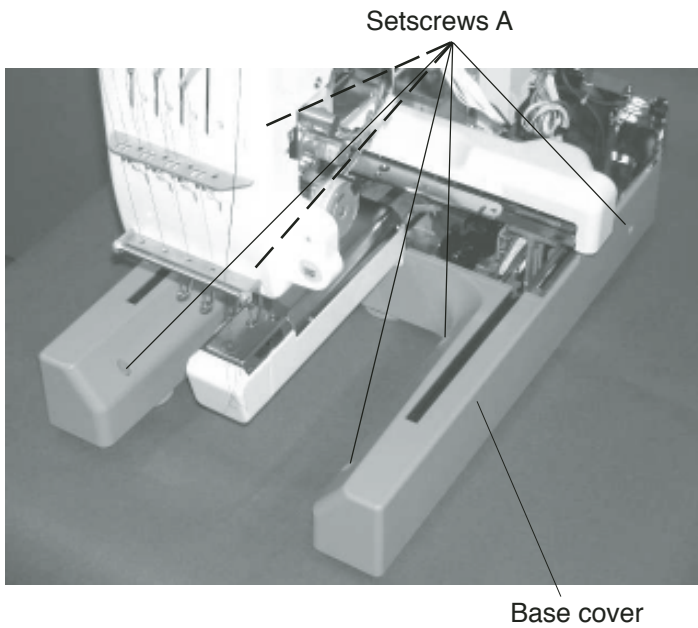

Base Cover

To remove:

1. Remove the 6 setscrews A.
2. Lift the back of the machine and remove it from the base cover.

To attach:

3. Attach the machine into the base cover.
4. Tighten the 6 setscrews A securely.

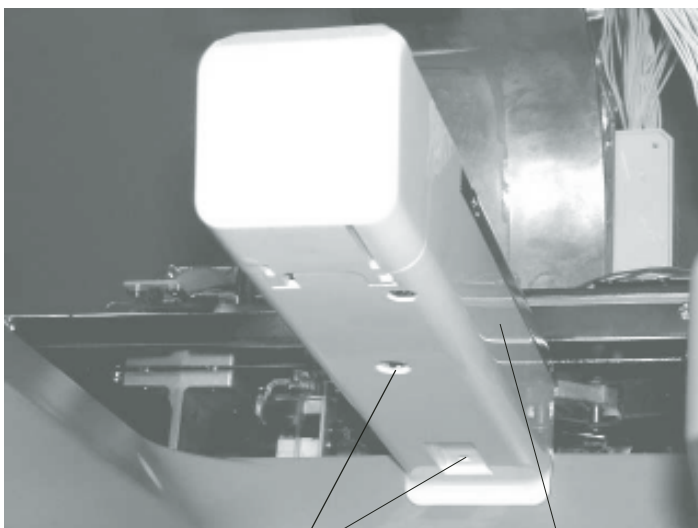
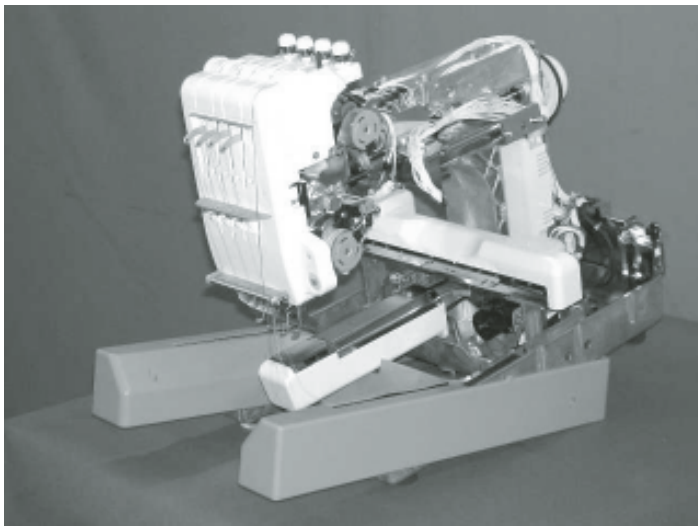

Bed Cover

To remove:

1. Remove the setscrews A. Remove the bed cover.

To attach:

2. Attach the bed cover with the setscrews A.

Setscrews A

Bed cover

Checking the Thread Paths (1)



Detectig roller

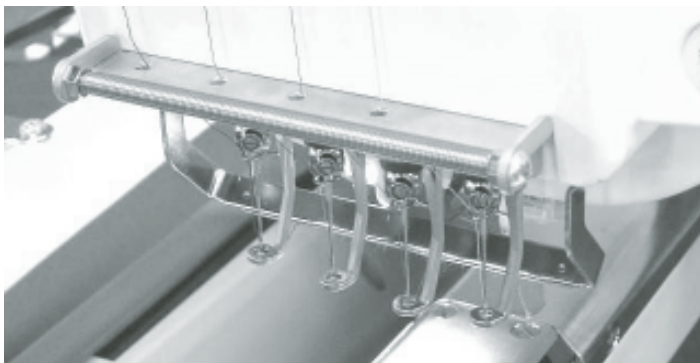

To avoid seam puckering, skipped stitches or thread breaking, keep the thread paths in the best condition.

1. Tension control, detecting roller
 - a) Detecting rollers should spin smoothly.
 - b) Tension controls and detecting rollers should be free of lint or dust.

2. Thread guide hole
 - a) There should be no burrs or scratches.

3. Thread take-up lever
 - a) There should be no burrs or scratches.

4. Lower guide plate
 - a) There should be no burrs or scratches.

5. Needle
 - a) The needle should not be bent or blunt.

To check the needle:

Place and slide the tip of the needle on your nail to check if there is any nick or chip. Replace the needle if it marks a scratch on your nail.

Place the needle onto something flat (needle plate, glass, etc.). The gap (A) between the needle and the flat surface should be consistent.

Replace the needle if the gap is not consistent.

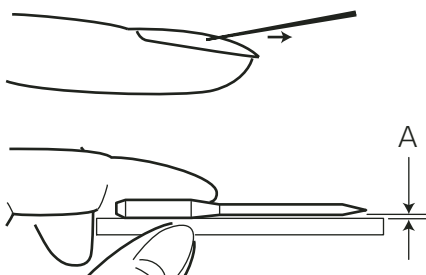

Checking the Thread Paths (2)

Upper side

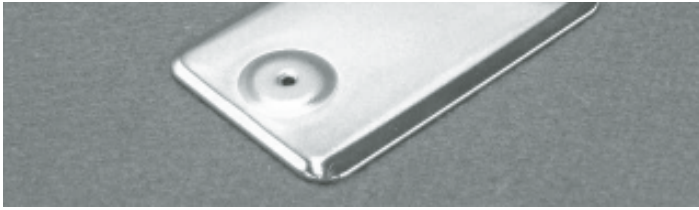

6. Needle plate
 - a) There should be no burrs or scratches.

Lower side

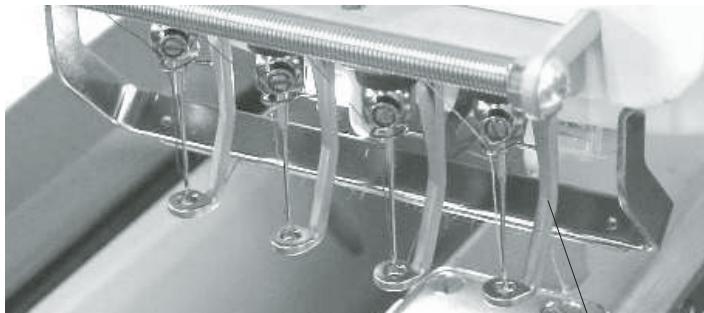

7. Presser foot
 - a) There should be no burrs or scratches, especially inside of the presser foot hole.
 - b) There should be no warp in the presser foot.

Presser foot

Hook

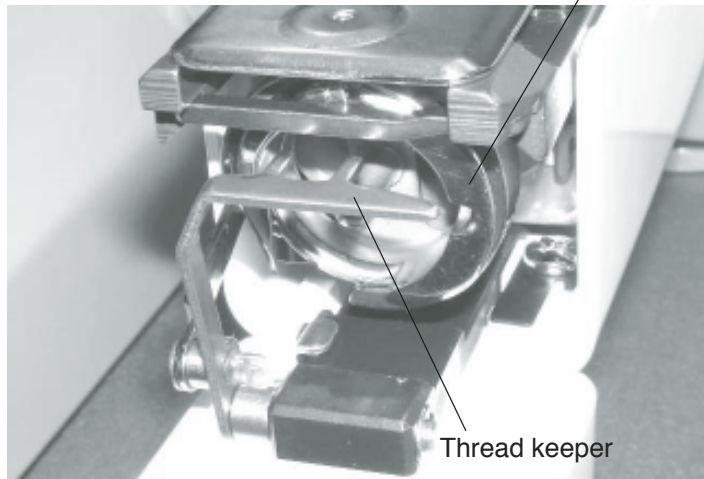

8. Hook race
 - a) There should be no burrs or scratches.
 - b) The tip of hook race should not be blunt.
 - c) There should be no detectable play in the hook and hook race.

9. Thread keeper
 - a) There should be no burrs or scratches, especially on the tip of the thread keeper.

Thread keeper

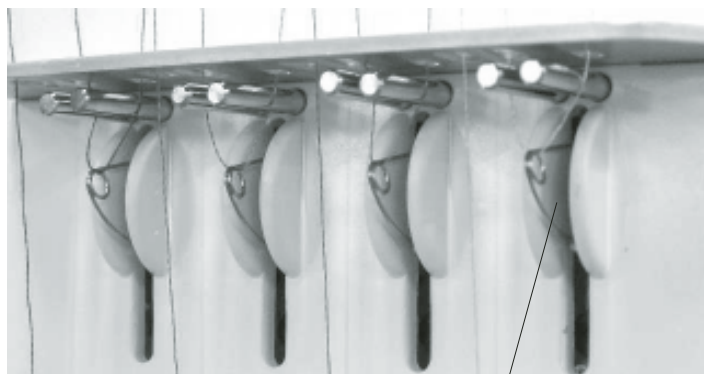

10. Check spring
 - a) The check spring should not be worn.

Check spring

Replacing the Needle

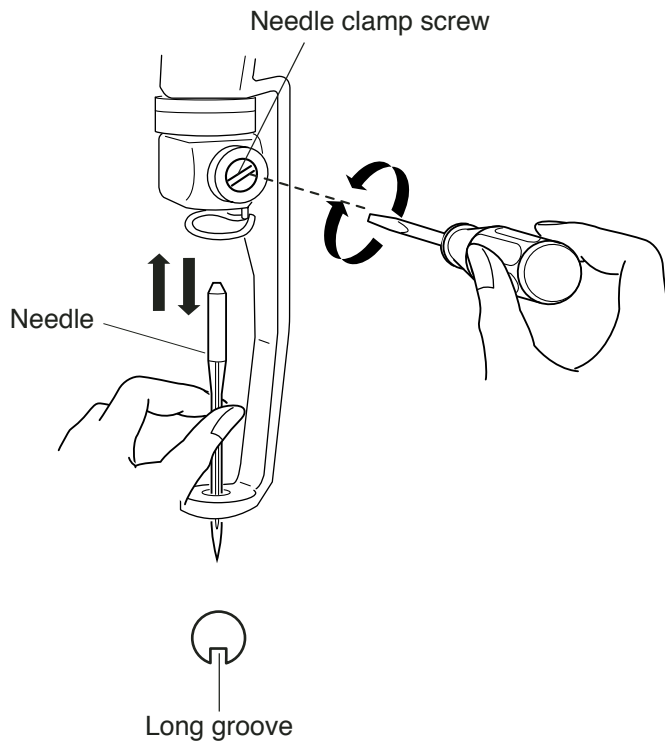
**To remove:**

1. Loosen the needle clamp screw.
2. Remove the needle.

To attach:

3. Insert the needle into the needle clamp with the long groove facing you. Push the needle up as far as it will go.
4. Tighten the needle clamp screw.

Needle and Thread Reference Table

Use DBxK5Q1NY needles and select an appropriate size of needle for threads and fabrics to be sewn.

An inappropriate size of needle may cause skip stitches, thread breakage or thread looping.

Please refer to the table below and select the suitable needle size.

Thread Size (Denier) Polyester	Needle Size
75	8~10
120	9~11
200	11~14

Checking the Lowest Position of the Needle

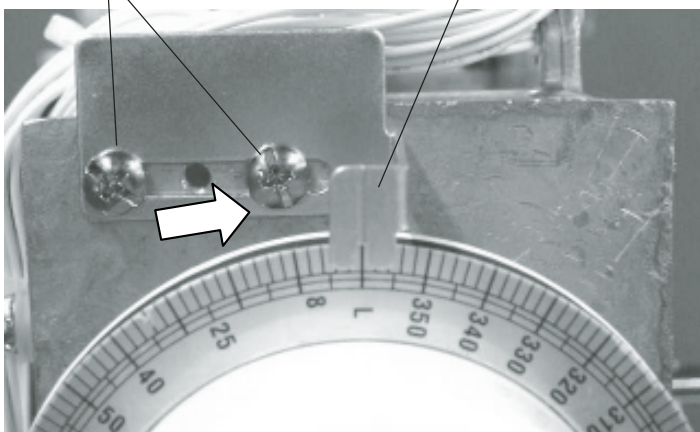
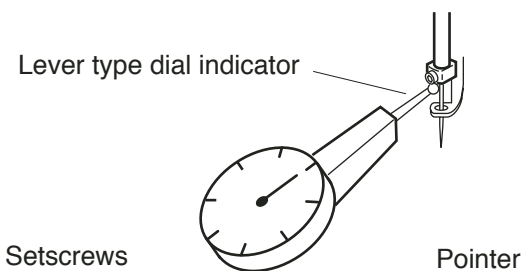
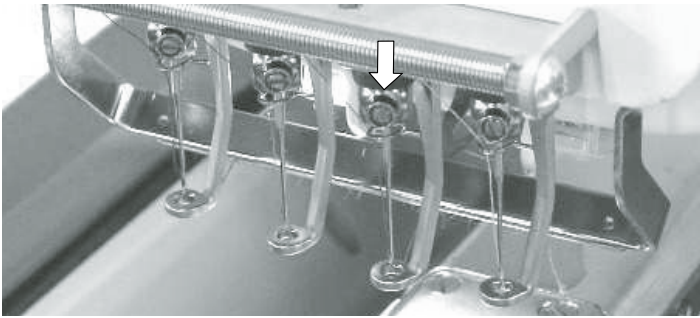
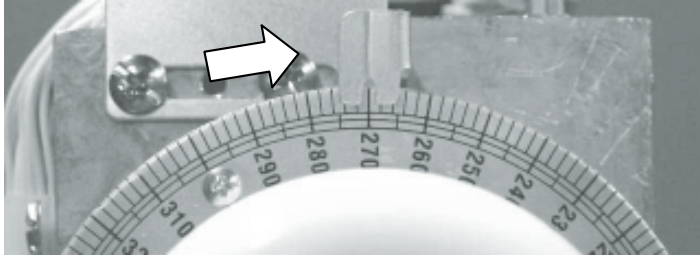

1. Remove the spool stand, static head cover (right) and left cover.
2. Turn the handwheel to set the index disk at 270°.
3. Push the needle bar down to engage the needle bar clutch.
4. Turn the handwheel to set the needle bar at its lowest position.
Use a lever type dial indicator to measure the needle bar height.
5. Turn the handwheel clockwise until the indicator reads 0.2 mm and read the angle (A°) of the index disk.
Turn the handwheel counterclockwise until the indicator reads 0.2 mm and read the angle (B°) of the index disk.

Calculate the mean angle (C°): $C = (A + B - 360) \div 2$
Turn the handwheel clockwise to set the index disk at C° .

Loosen the 2 setscrews and set the pointer at 0° (L). Tighten the 2 setscrews securely.

Check the following items if you have adjusted the lowest position of the needle.

- Upper shaft timing
- Take-up lever timing
- Hook timing
- Thread cutter timing

Replacing the Needle Bar Rest

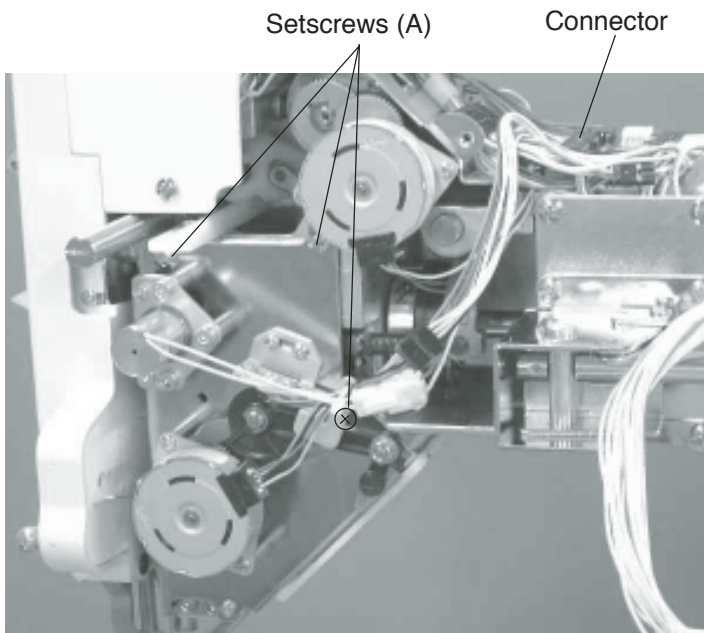

To remove:

1. Remove the spool stand, static head cover (right), right cover and left cover.
2. Disconnect the thread catcher unit connector. Remove the 3 setscrews (A). Remove the thread catcher unit. Remove the moving head (see pages 22, 23).

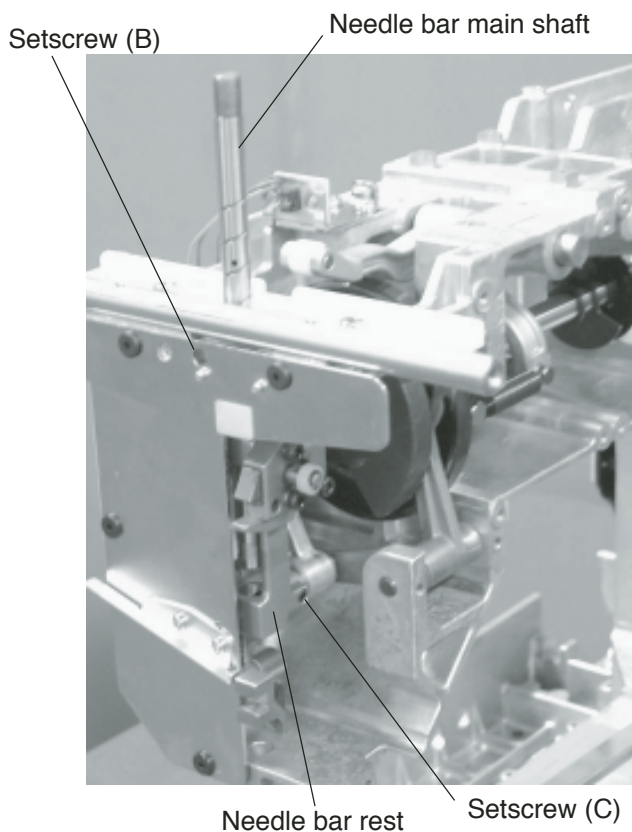

3. Loosen the setscrew (B). Pull the needle bar main shaft up and remove it from the machine.
4. Loosen the setscrew (C) and remove the needle bar rest from the needle bar main shaft.

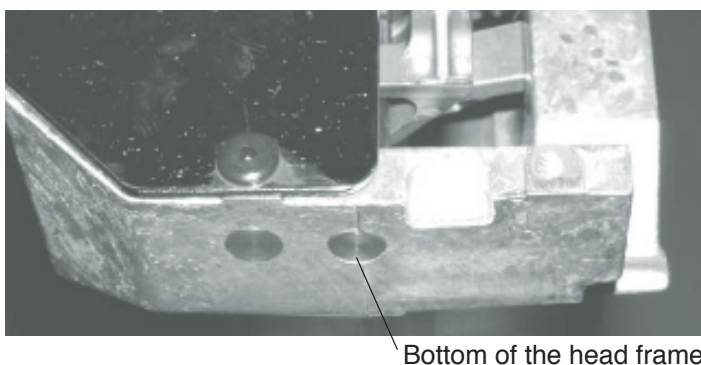

To attach:

5. Reverse the procedure above. Attach the needle bar main shaft so its bottom end is level with the bottom surface of the head frame.
6. Adjust the needle height after the replacement.

Replacing the Take-up Lever Cam Roller

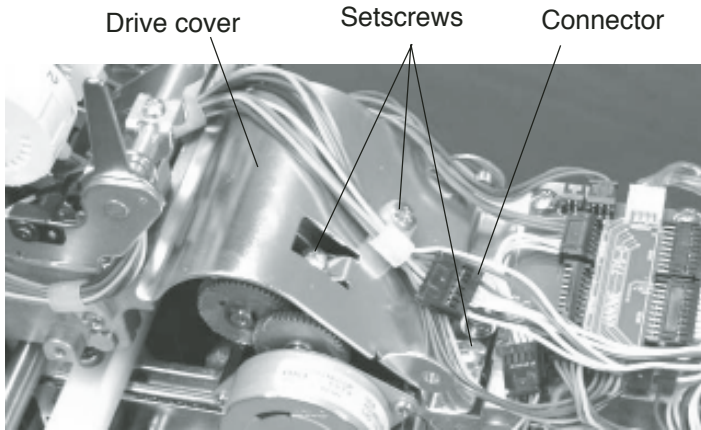

To remove:

1. Remove the spool stand, static head cover (right), right cover, left cover and thread tension panel.
2. Remove the 3 setscrews and drive cover.

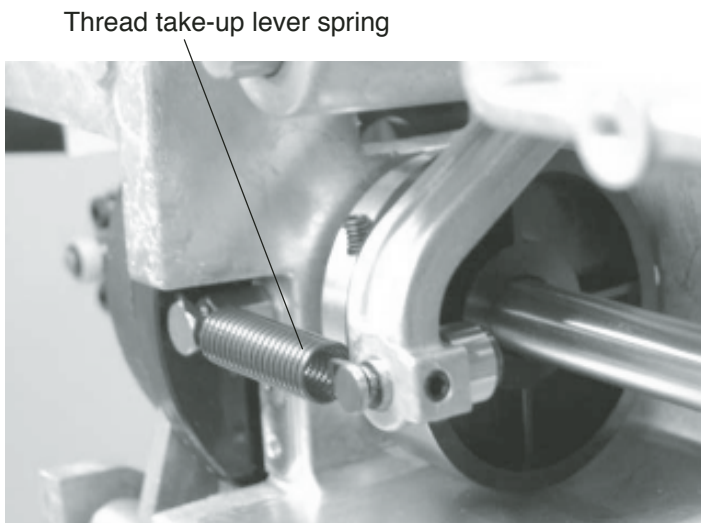

3. Remove the thread take-up lever spring with pliers.

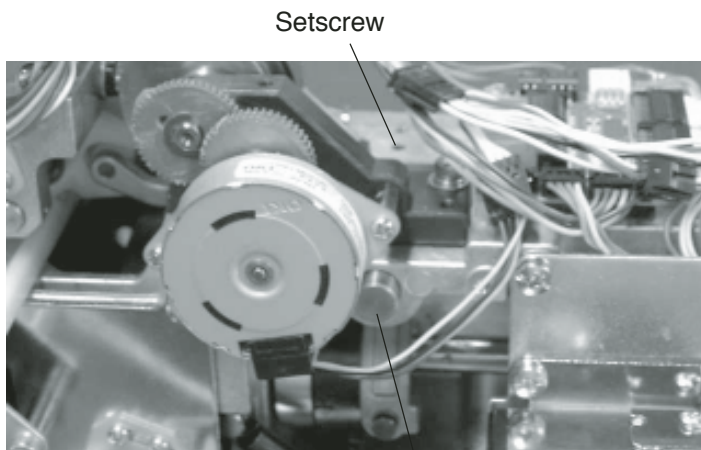

4. Loosen the setscrew. Remove the thread take-up lever shaft, thread take-up lever unit and washer.

Thread take-up lever shaft Thread take-up lever shaft Thread take-up lever unit

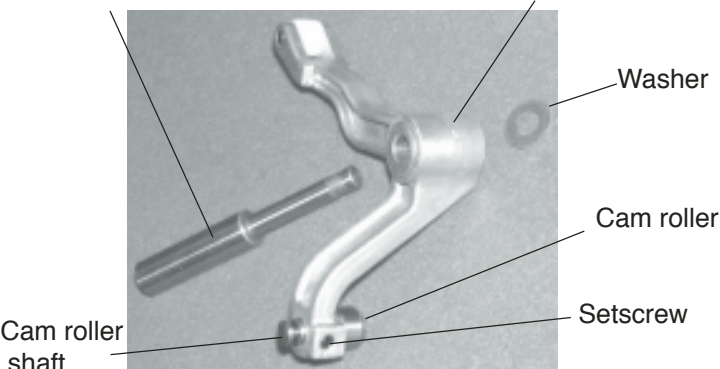

5. Loosen the setscrew. Remove the cam roller shaft and cam roller.

To attach:

6. Reverse the procedure above. When attaching the thread take-up lever shaft, tighten the screw while pressing the thread take-up lever shaft lightly.

Adjusting the Take-up Lever Timing

To remove:

1. Remove the spool stand, static head cover (right), right cover and left cover.
2. Turn the handwheel to set the index disk at 6°.
3. Insert the positioning pin from the left side of the arm.
The positioning pin goes into the pin groove of take-up lever cam if the timing is correctly adjusted.

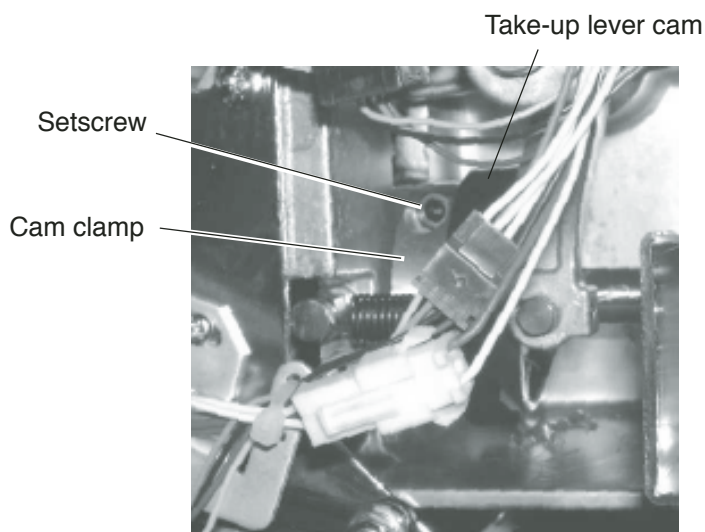
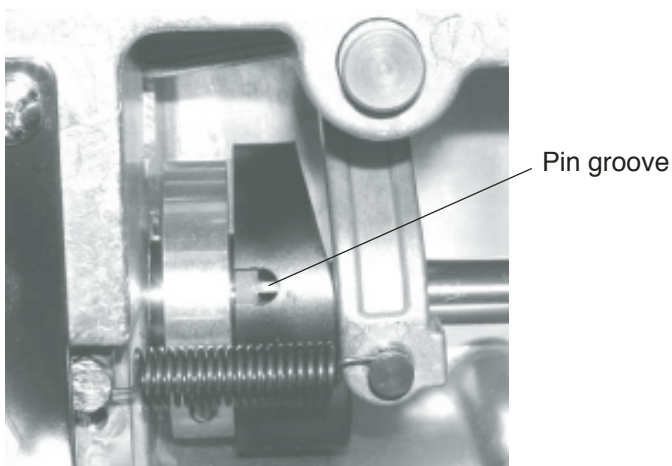
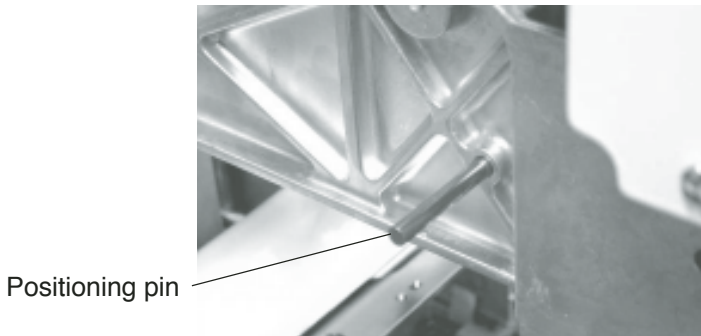
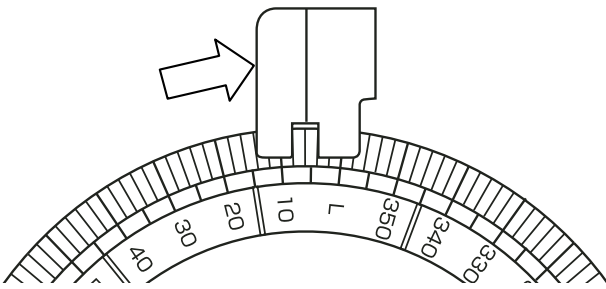

4. If the timing is incorrect, loosen the setscrew on the cam clamp and turn the take-up lever cam so the positioning pin can go into the pin groove on the cam.
Turn the handwheel to set the index disk at 6°. Tighten the setscrew on the cam clamp while pressing the take-up lever cam to the side of the moving head. There should be no gap between the take-up lever cam and cam clamp.
5. Pull the positioning pin out from the arm.
Turn the handwheel to set the index disk at 270°. Attach the removed parts.

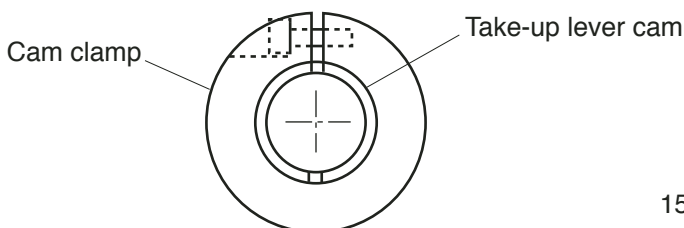

Replacing and Adjusting the Presser Foot (1)

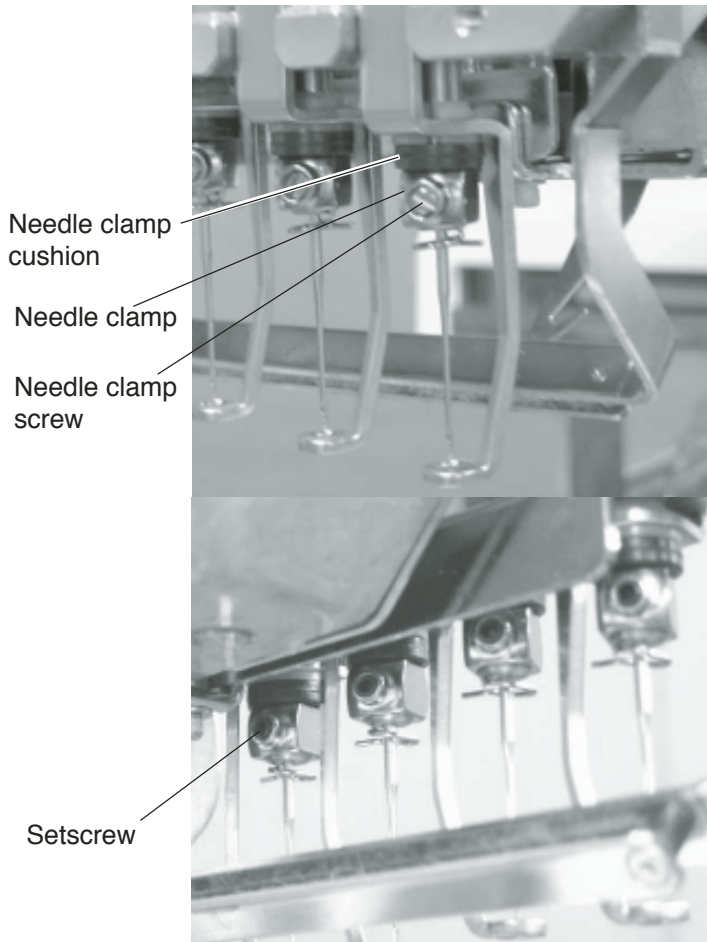

1. Remove the lower thread guide plate unit and thread catcher panel.
2. Loosen the needle clamp screw and the setscrew. Remove the needle, needle clamp and two needle clamp cushions.

NOTE:

The presser foot will spring down when the needle clamp is removed.

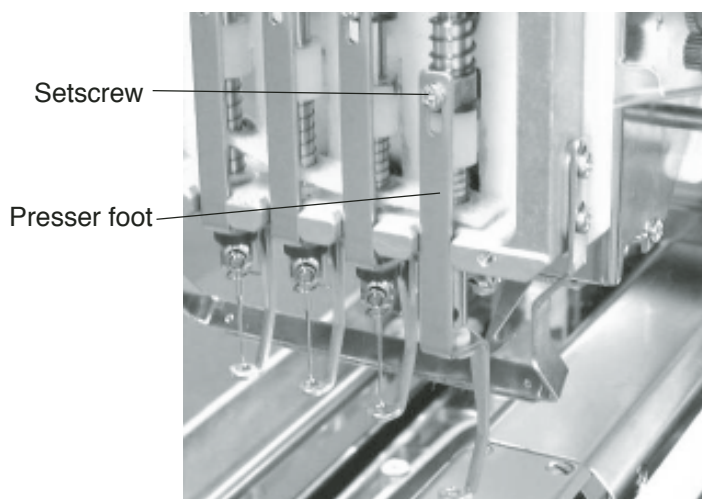

3. Remove the setscrew and replace the presser foot.
4. Attach the needle, needle clamp and needle clamp cushions. Tighten the needle clamp screw and setscrew.
5. Adjust the needle height. (see To Adjust the Needle Height)

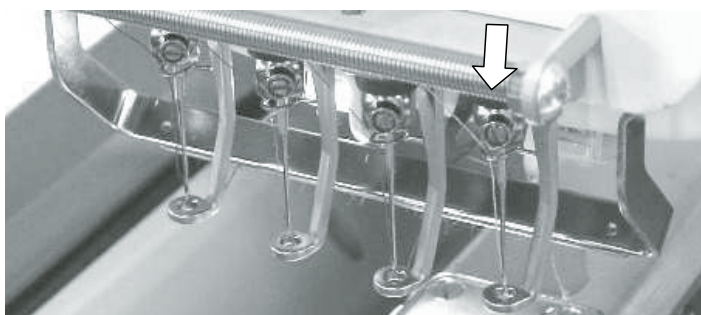

6. Push the needle bar down to engage the needle bar clutch.

Replacing and Adjusting the Presser Foot (2)

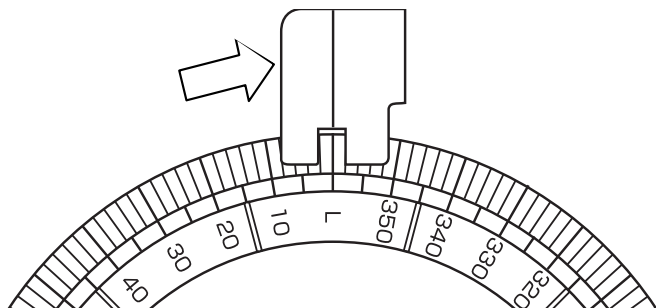

7. Turn the handwheel to set the index disk at 0 degree (L).

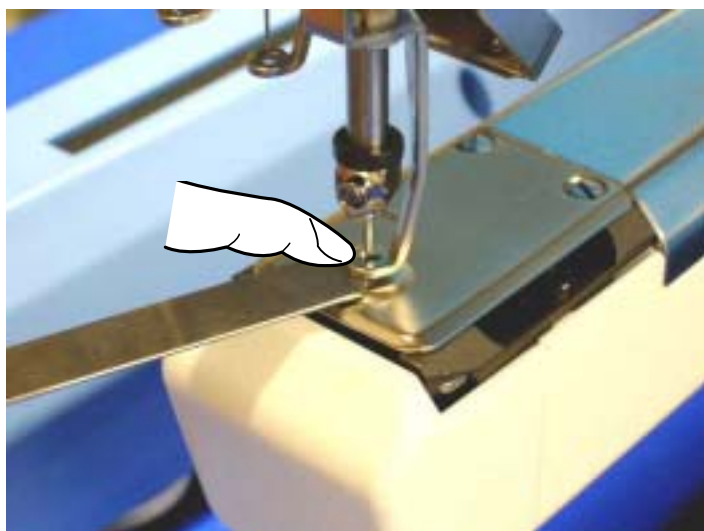

8. Insert the 1.2 mm thick gauge (770-904-001) between the needle plate and the presser foot.

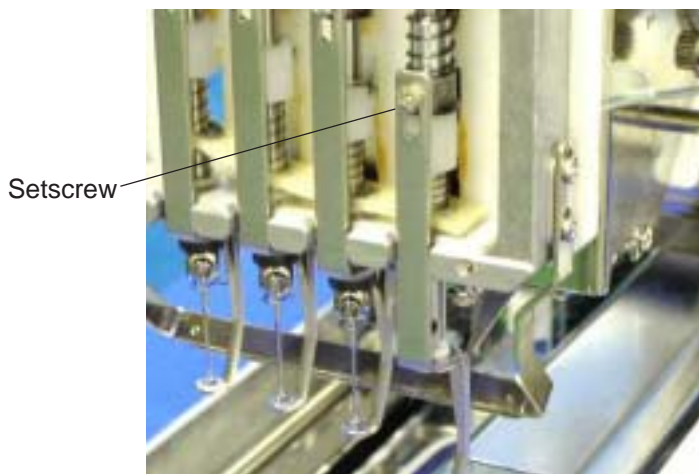

9. Tighten the setscrew.

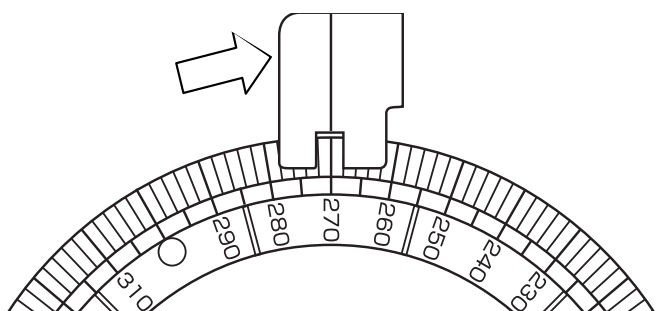

10. Turn the handwheel to reset the index disk at 270 degrees.

11. Attach the removed parts.

Replacing the Thread Catcher Unit

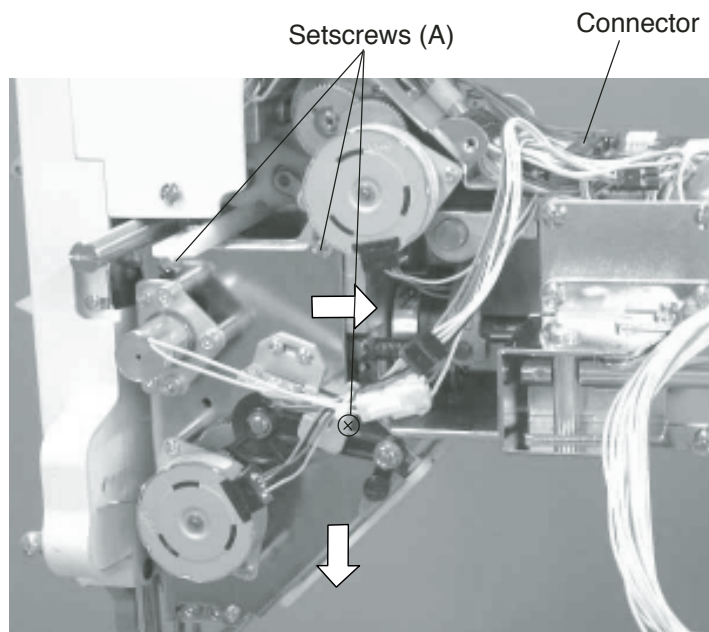

To remove:

1. Remove spool stand, head cover (right), right cover, left cover, moving head and lateral moving unit.
2. Disconnect the thread catcher connector. Remove the 3 setscrews (A), the thread catcher.

To attach:

3. Connect the thread catcher connector. Tighten the setscrews (A) while pressing the thread catcher unit in the direction of arrows as illustrated.
4. Adjust the thread catcher (see page 31).
5. Attach removed parts.

Replacing the Thread Catcher Hook

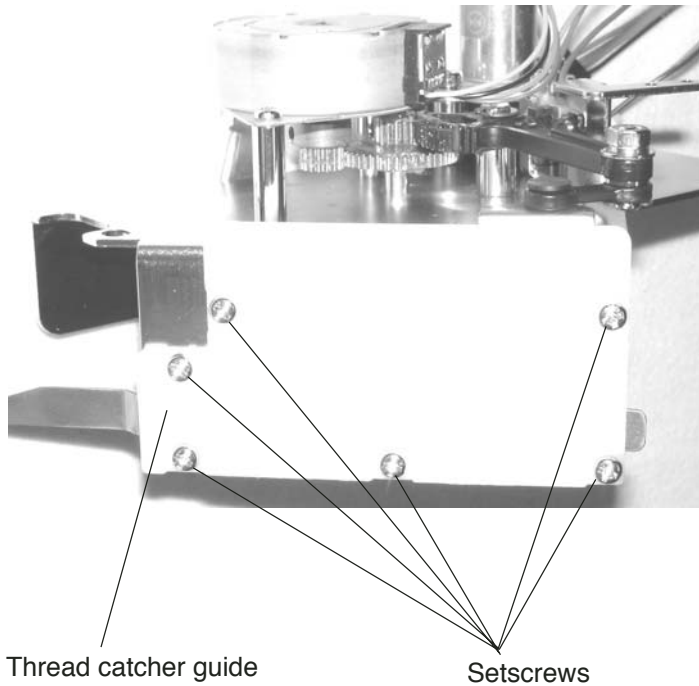

To remove:

1. Remove the thread catcher unit (see page 18).
2. Loosen the 6 setscrews and remove the thread catcher guide.
3. Remove the thread catcher hook screw. Remove the thread catcher hook.

To attach:

4. Attach the thread catcher hook with the thread catcher hook screw.
5. Attach the thread catcher guide with the 6 setscrews.
6. Attach the thread catcher unit (see page 18).

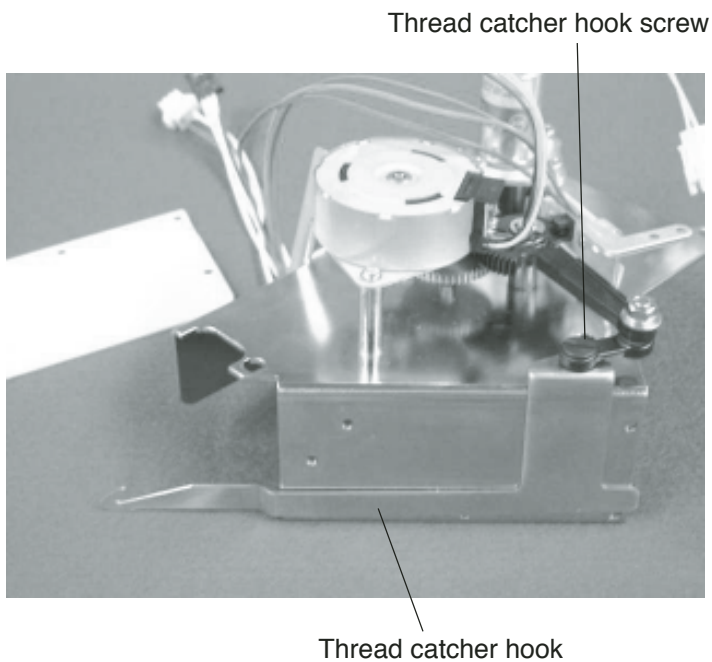

Replacing the Jump Solenoid

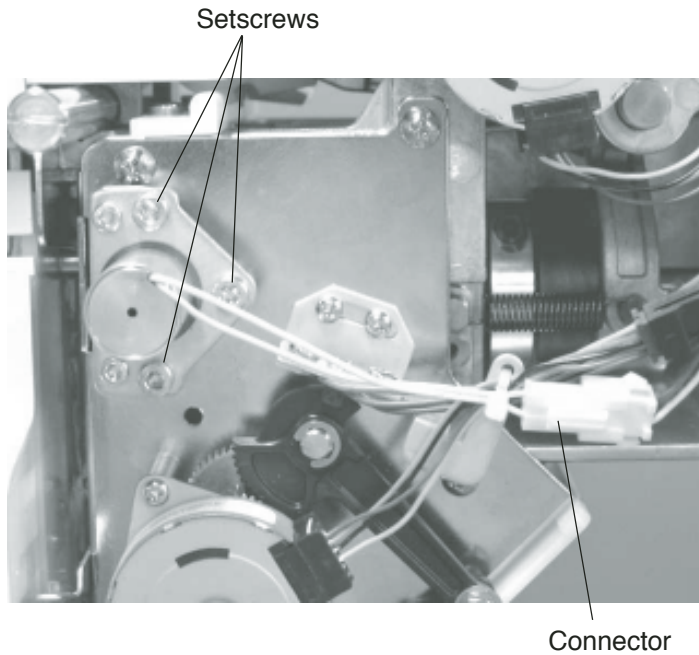

1. Remove the static head cover (right).
2. Disconnect the connector. Remove the 3 setscrews and jump solenoid.

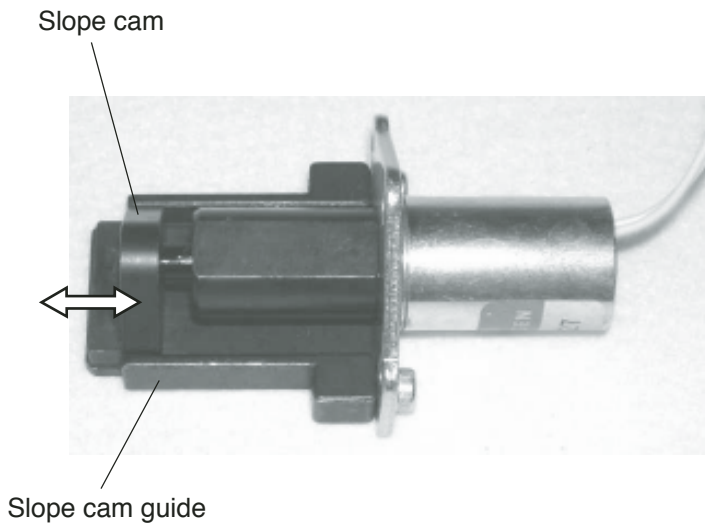

3. The slope cam should slide on the slope cam guide smoothly. Clean the solenoid if there is any lint or dust on it.

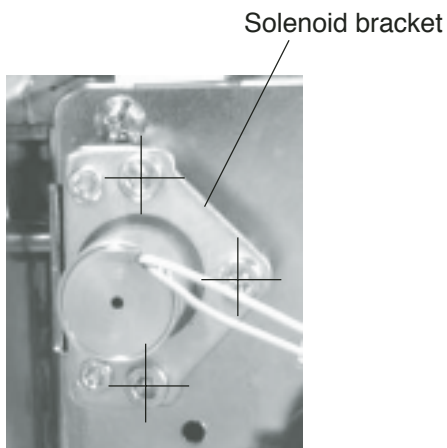

4. Attach the jump solenoid to the machine. Tighten the setscrews. Setscrews should be positioned at center of holes.
5. Attach the static head cover (right).

Adjusting a Play in the Moving Head

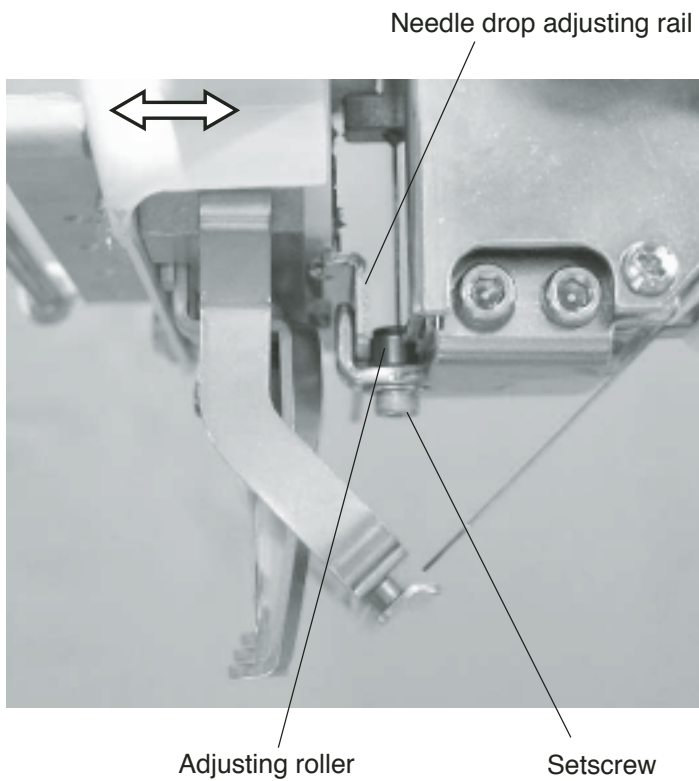

1. Remove the static head cover (right).
2. Check the play in the direction of the arrows. If there is a detectable play, loosen the setscrew and tighten it while pressing the adjusting roller against the needle drop adjusting rail.
3. Adjust the needle drop position (see page 24).
4. Attach the static head cover (right).

Replacing the Moving Head (1)

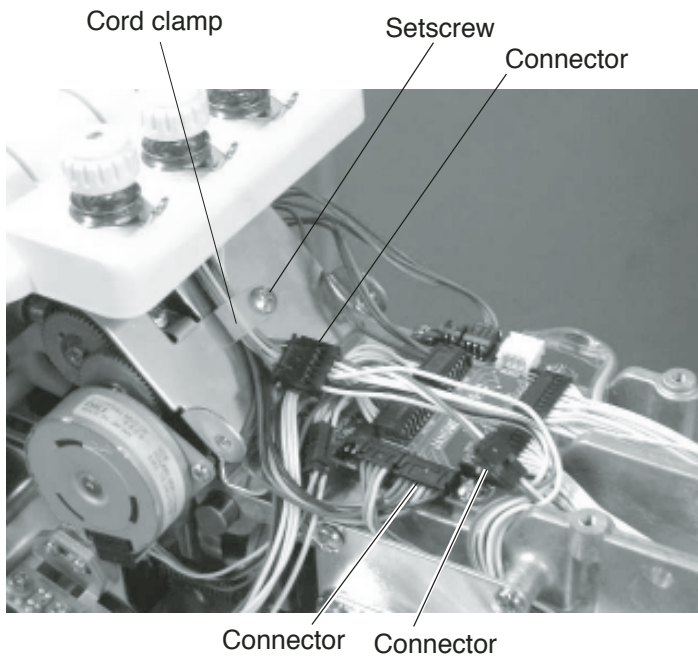

To remove:

1. Remove the spool stand, static head cover (right), right cover and left cover.
2. Disconnect the connectors. Remove the setscrew of the cord clamp.

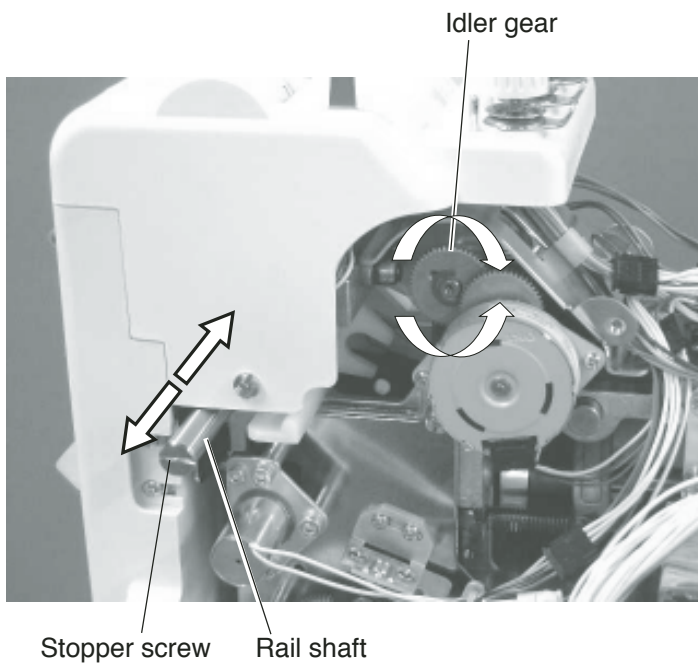

3. Remove either the left or right side of stopper screw on the rail shaft.
4. Turn the idler gear to move the moving head to the end of the rail shaft with the stopper screw removed.
Support the moving head securely while removing the moving head so as not to fall.

To attach:

5. Attach the moving head. Tighten the stopper screw.

Replacing the Moving Head (2)

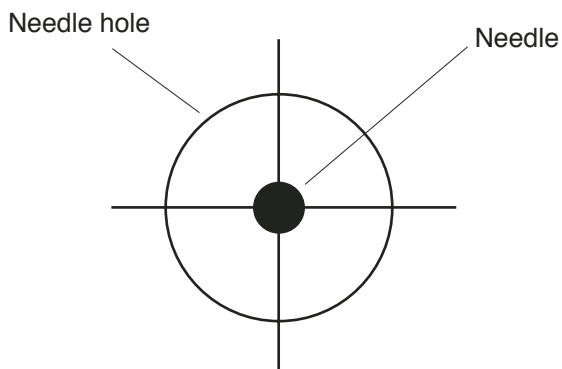
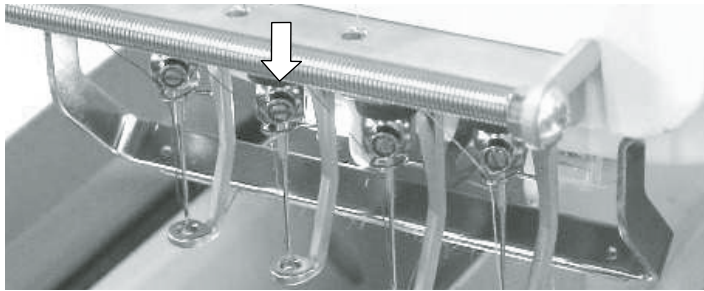
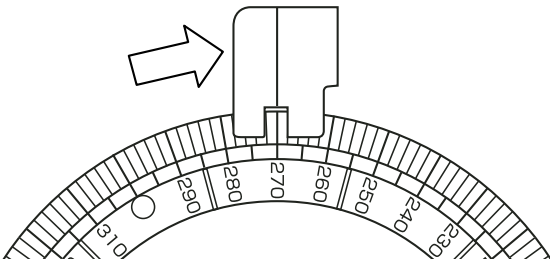

6. Turn the handwheel to set the index disk at 270°.

7. Turn the idler gear to set the moving head to the needle bar No. 3.
Push the needle bar No. 3 down to engage the needle bar clutch.

8. Turn the handwheel until the needle goes into the needle hole.

9. Check the needle drop position. The needle drop position should be the center of the needle hole.

If the needle drop position is off position to the front or rear, adjust the needle drop position (see the next page).

If the needle drop position is off position in the lateral direction, adjust the position of the lateral moving head (see page 33).

10. Turn the handwheel to set the index disk at 270°

11. Connect the connectors and attach the parts removed.

Adjusting the Needle Drop Position (Back or Forth)

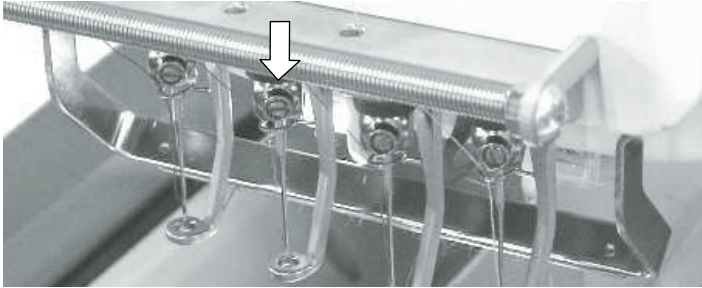

1. Set the moving head to needle bar No. 3 (see pages 26 and 39 of the instruction book). Push the needle bar No. 3 down to engage the needle bar clutch.

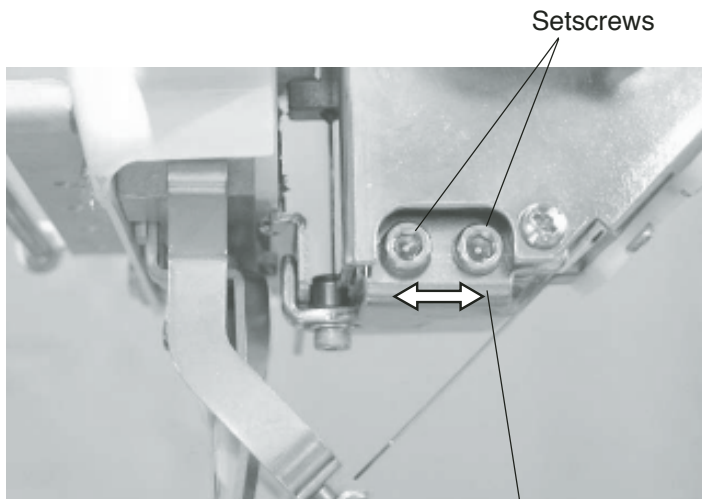

2. Turn the handwheel until the needle goes down into the needle hole. Loosen the 2 setscrews. Adjust the needle drop position adjusting plate. Center the needle drop position in the needle hole.

3. Adjust the hook timing (see page 34).

Needle drop position adjusting plate

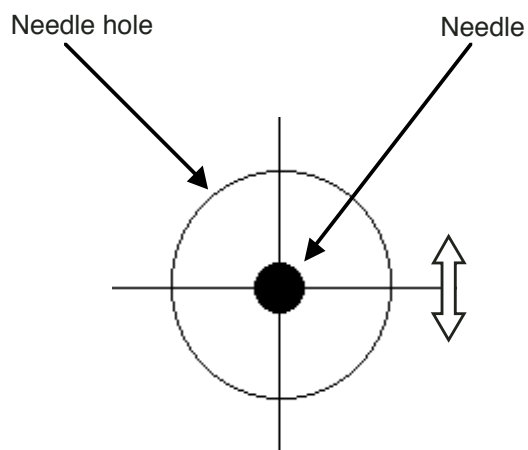

Adjusting the Needle Height

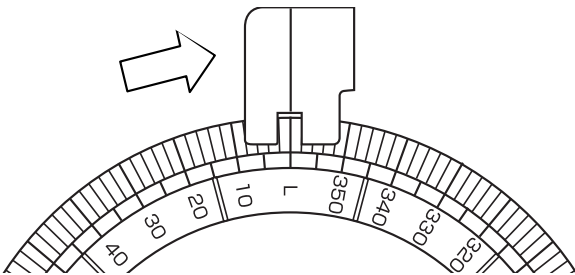
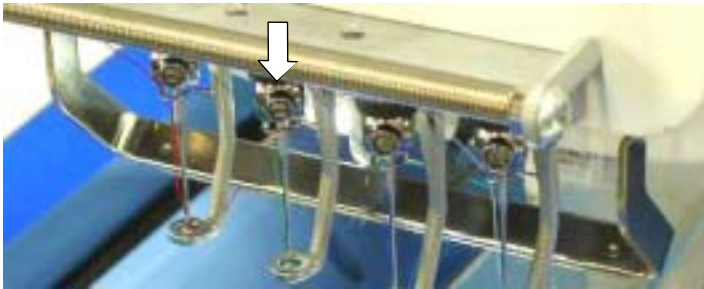

Setscrew

Needle bar height gauge (770-903-000)

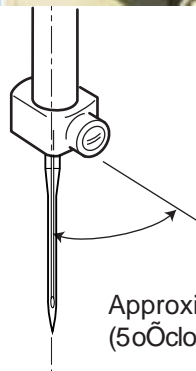
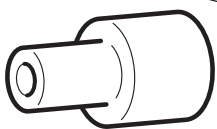

Approximately 30;
(5 o'clock)

1. Remove the lower thread guide plate and thread catcher panel.
2. Remove the bobbin case.
3. Push the needle bar down to engage the needle bar clutch.
4. Turn the handwheel to set the index disk at 0 degree (L).
5. Loosen the setscrew.
6. Insert the needle bar height gauge into the hook.
7. Adjust the needle bar height so the tip of needle slightly touches the gauge.
8. Adjust the direction of needle clamp as illustrated below (the needle clamp screw is at 5 o'clock). Tighten the setscrew.
9. Remove the needle bar height gauge.
10. Turn the handwheel to set the index disk at 270 degrees.
11. Attach the removed parts.

Replacing the Needle Bar, Needle Spring and Cushion

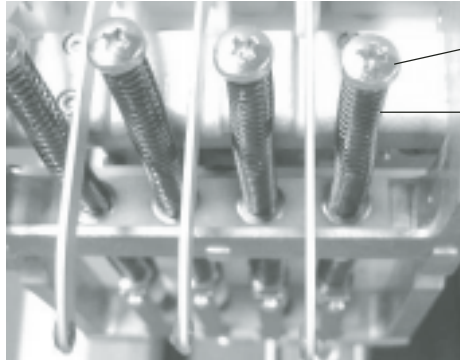

Needle bar

Needle bar spring



Needle bar holder

Needle bar holder screw

Spring base

Presser foot spring (lower)

Presser foot block

Stop felt

Presser foot holder

Presser foot return spring

Washer

1. Remove the presser foot (see pages 16 and 17).
2. Loosen the needle bar holder screw.
3. Pull the needle bar up and out of the frame. To remove the parts on the needle bar, pull the needle bar as far as the desired part can be removed.
4. Insert the needle bar down into the frame and put the parts on the needle bar as it goes.
5. Attach the presser foot.
6. Adjust the needle height (see page 25).
7. Adjust the presser bar height (see pages 16 and 17).

Replacing the Rotation Stopper Plate

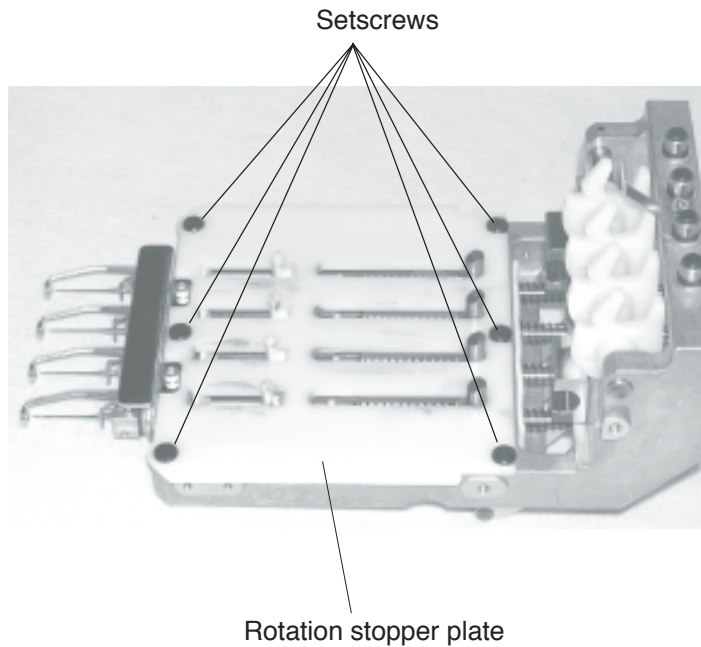

To remove:

1. Remove the moving head (see pages 22 and 23).
2. Remove the 6 setscrews and rotation stopper plate.

To attach:

3. Attach the rotation stopper plate with the 6 setscrews. The setscrews should be positioned at the center of each holes when tightening each setscrews.
4. Attach the moving head.

Replacing the Thread Take-up Lever

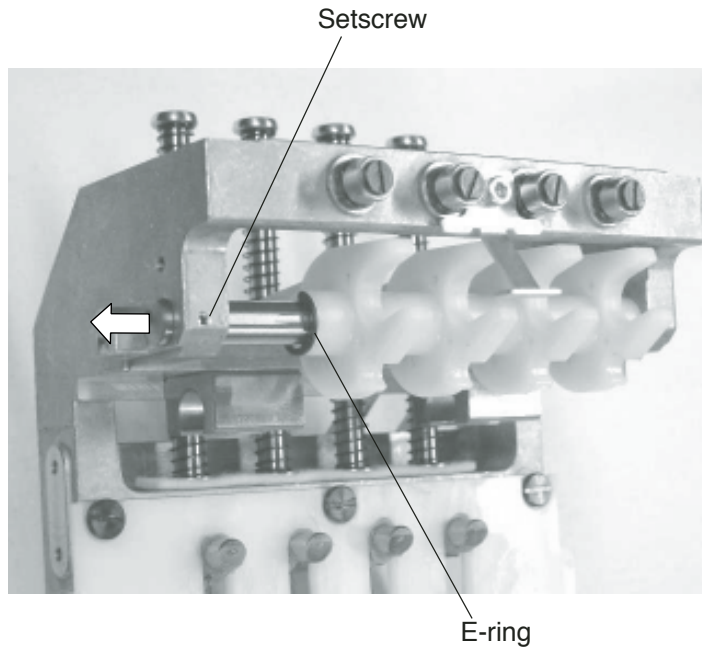

1. Remove the moving head (see pages 22 and 23).
2. Remove the E-ring.
3. Loosen the setscrew on the thread take-up lever shaft.
4. Pull the thread take-up lever shaft out in the direction of the arrow. Remove the thread take-up lever to replace.
5. Replace the thread take-up lever.
6. Attach the E-ring.

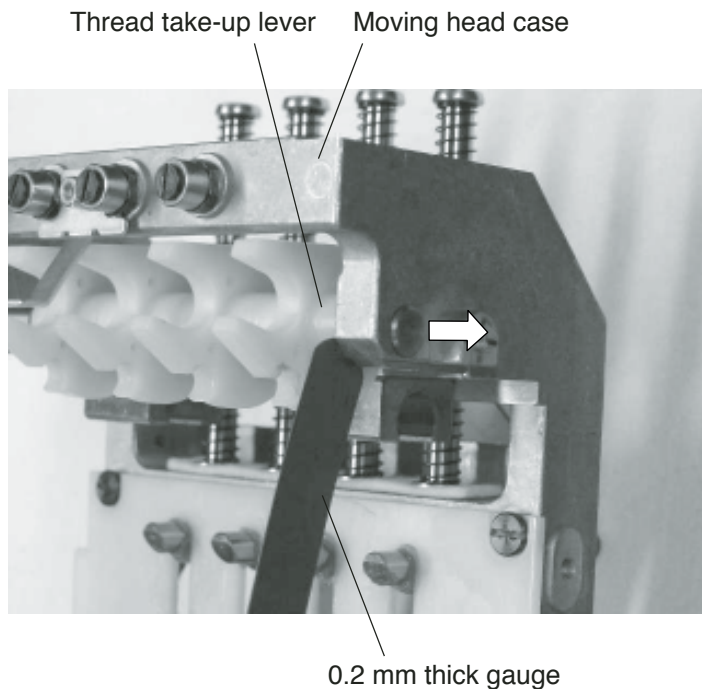

7. Insert a 0.2 mm thick gauge between the moving head case and thread take-up lever. Tighten the setscrew while pressing the thread take-up lever shaft in the direction of the arrow.
8. Attach the moving head.

Adjusting the Check Spring Tension

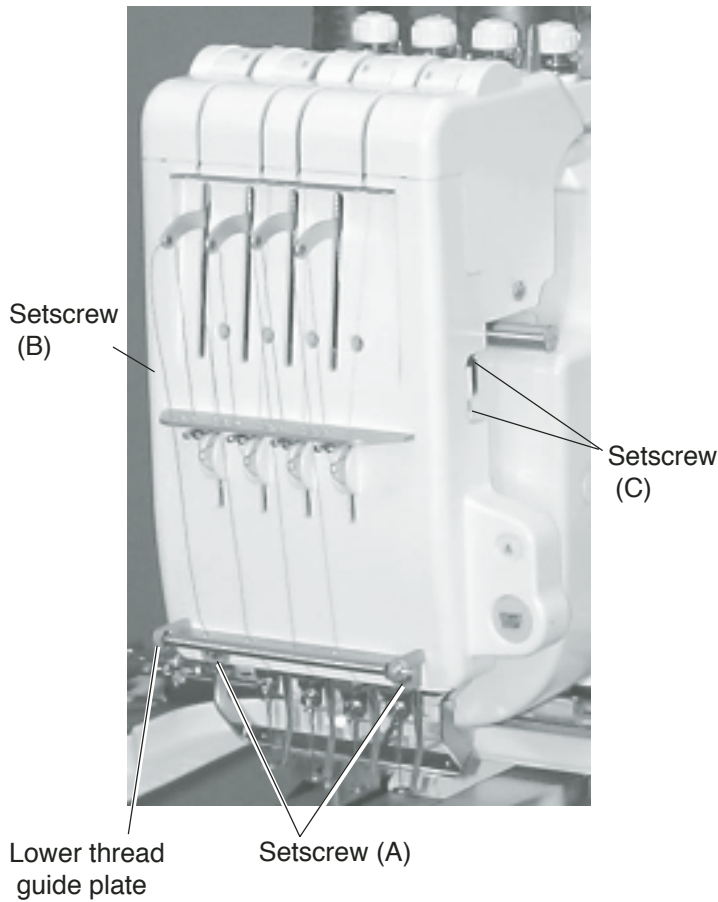

Check spring tension is not necessary to adjust under normal conditions.

However, you need to adjust the tension of the check spring when it is replaced.

1. Remove the 2 setscrews (A) and lower thread guide plate.
2. Loosen the 2 setscrew (B), 2 setscrews (C) and thread catcher panel.
3. Hook the tail of the check spring into the one of three slits. Use a narrow screwdriver to hook the check spring.
 - Top slit: Higher tension
 - Center slit: Standard tension
 - Bottom slit: Lower tension
4. Attach the thread catcher panel and lower thread guide plate.

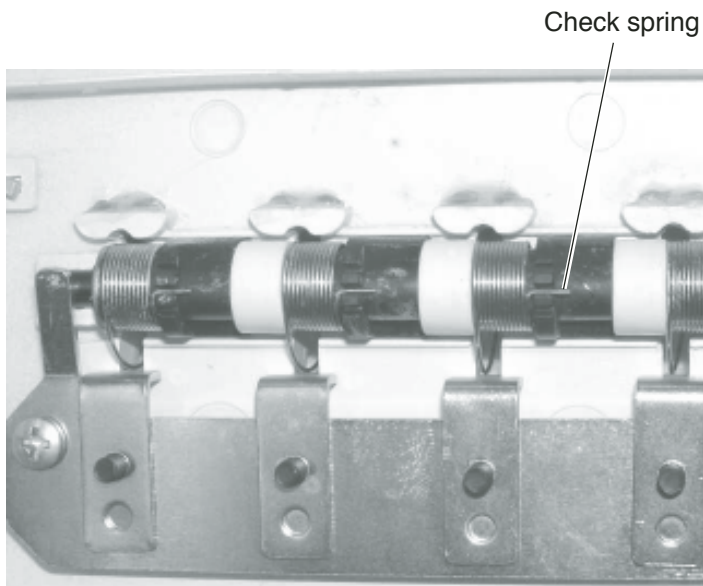

Adjusting the Check Spring Stroke

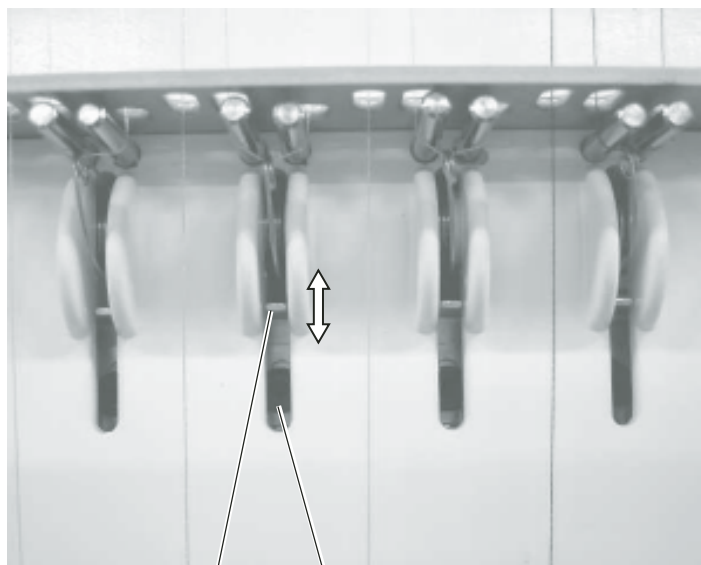

Adjustor

Setscrew

Check spring stroke is not necessary to adjust under normal conditions.

However, you need to adjust the stroke of the check spring when it is replaced.

1. Loosen the setscrew. Move the adjuster up or down so the distance between the top of the check spring and the bottom side of the thread guide pin is 7 mm.

For a longer stroke, move the adjuster down.
For a shorter stroke, move the adjuster up.



7mm

Adjusting the Thread Catcher Holder

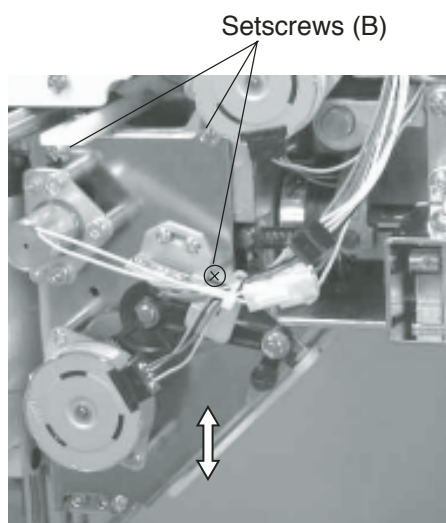
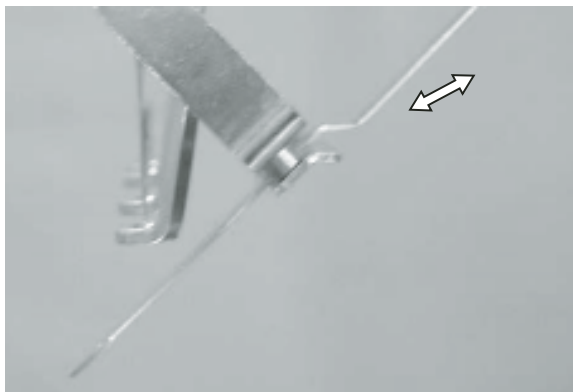
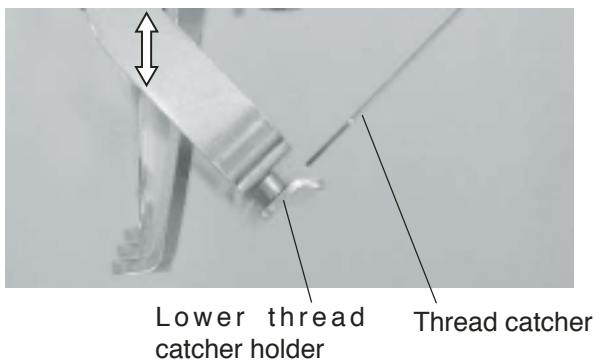
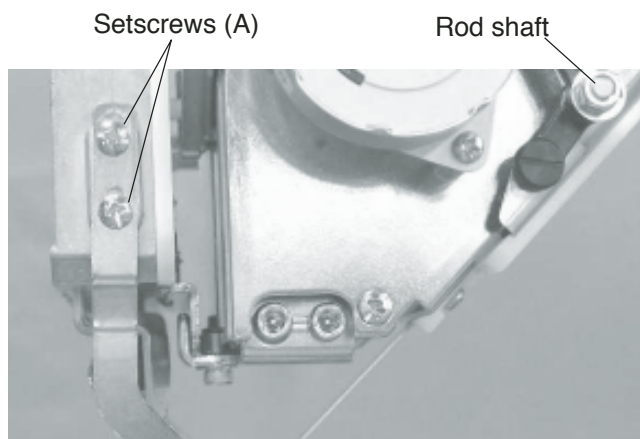

1. Remove the static head cover (right) (see page 5).
2. Remove the thread catcher panel and lower thread guide plate (see pages 18 and 19).
3. Loosen the 4 setscrews (A).
4. Pull the thread catcher out to set the tip of the thread catcher on the lower thread catcher holder. Move the thread catcher holder up or down so the lower surface of the thread catcher touches the upper surface of the lower thread catcher holder.

NOTE:

If an adjustment allowance of the thread catcher holder is not enough, loosen the 3 setscrews (B) and move the thread catcher unit.

5. Check if the thread catcher moves smoothly by moving the rod shaft with your hand. Tighten the 4 setscrews (A).
6. Press the thread cutter button to test thread cutting and catching.
7. Attach the parts removed in steps 1 and 2.

Replacing the Thread Catcher Loop Tape

1. Remove the static head cover (right) (see page 5).
2. Remove the thread catcher panel and lower thread guide plate (see pages 18 and 19).
3. Remove the 4 setscrews (A) and remove the thread catcher holder unit.
4. Remove the 2 setscrews (B) and remove the 2 spacers (S) and lower thread catcher holder.
5. Peel the loop tape off. Stick a new loop tape on the bottom side of the thread catcher holder, aligning with the front edge of the holder. Leave a 2 mm space from the threaded hole at each side.
6. Attach the 2 spacers (S) and lower thread catcher holder with the 2 setscrews (B).
7. Attach the parts removed in steps 1 and 2.

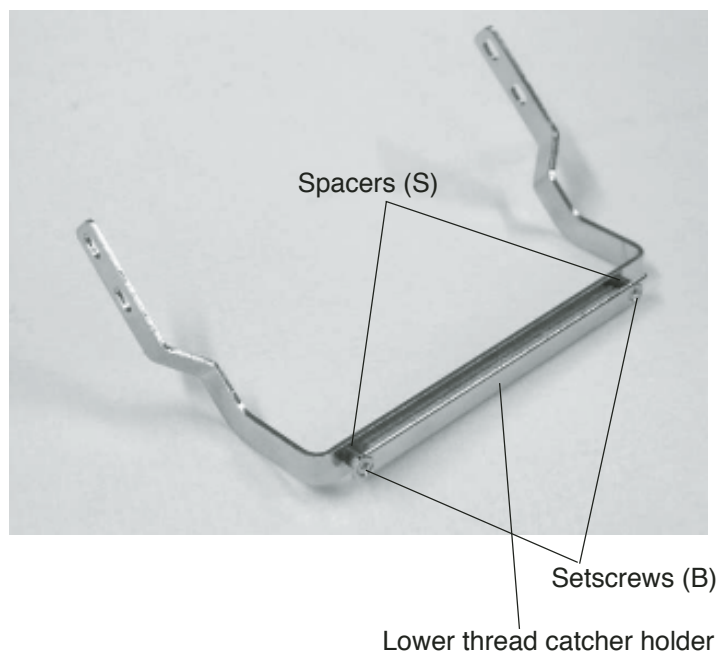
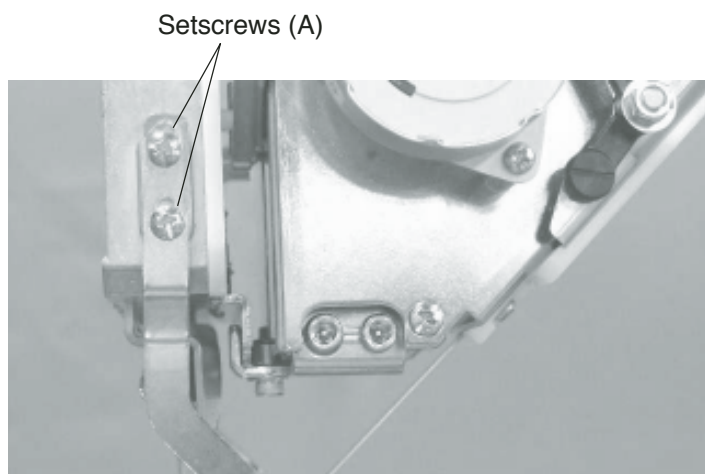

Upper thread catcher holder

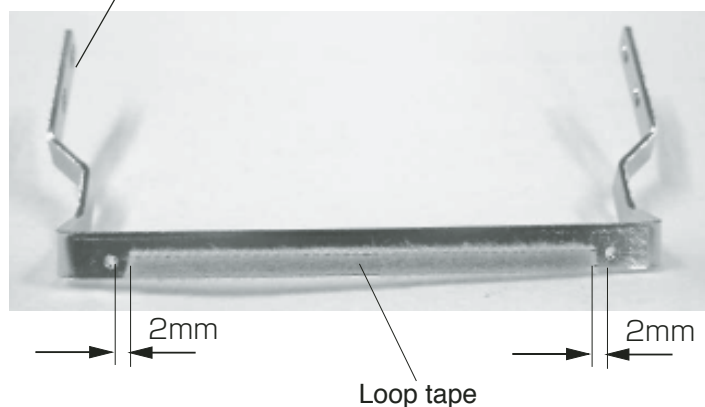

Replacing the Lateral Moving Unit

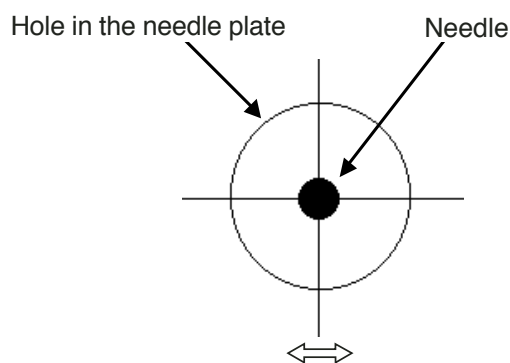
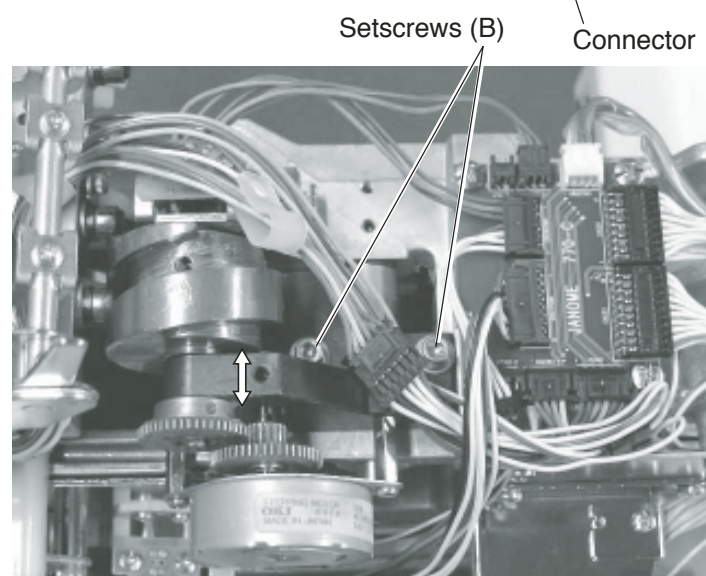
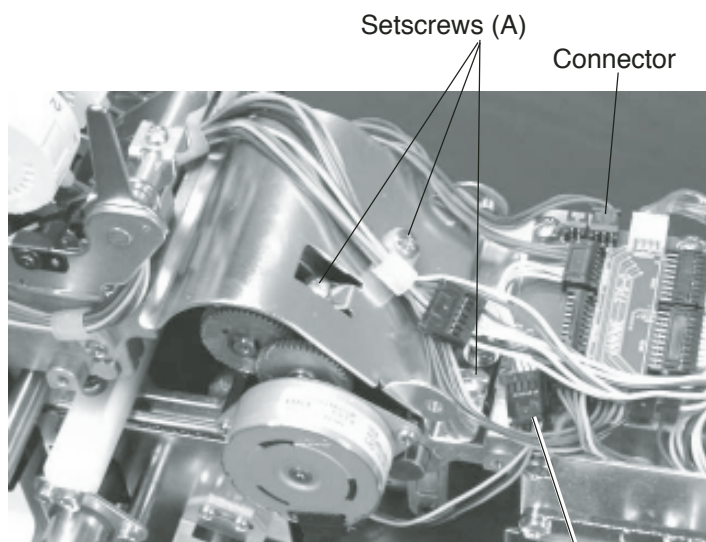

To remove:

1. Remove the spool stand, static head cover (right), right cover and left cover (see pages 4 and 5).
2. Remove the tension unit cover (see page 4).
3. Remove the three setscrews (A) and remove the driver cover.
4. Disconnect the connectors.
5. Remove the two setscrews (B) and remove the lateral moving unit.

To attach:

6. Attach the lateral moving unit and loosely fix it with the 2 setscrews (B).
7. Push the needle bar down and rotate the handwheel to set the index disk at "L".
8. Adjust the position of the lateral moving unit so the needle enters into the center of the hole in the needle plate. Tighten the 2 set screws (B) securely.
9. Connect the connectors and attach the parts removed in steps 1 to 3.

Adjusting the Hook Timing

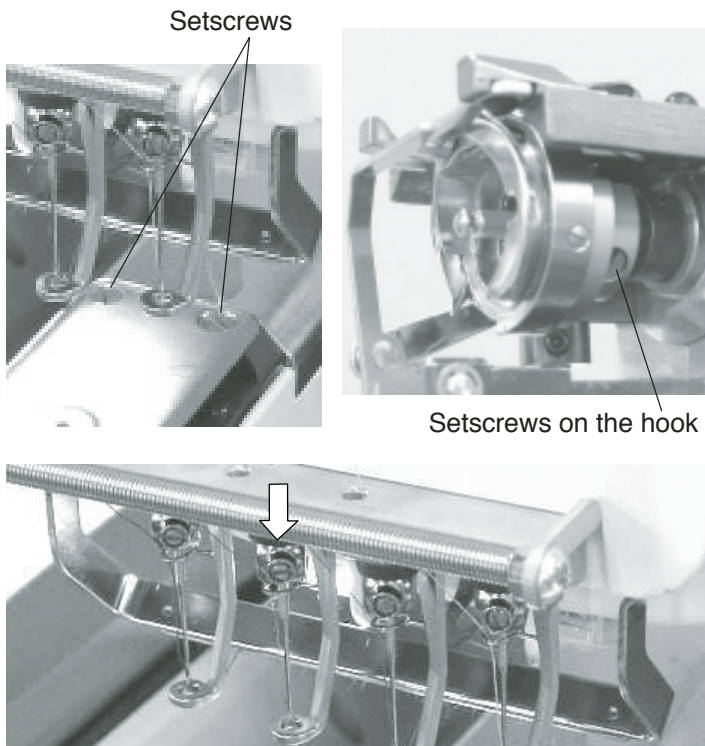

1. Remove the 2 setscrews and needle plate.
2. Loosen the 3 setscrews on the hook.
3. Select No. 3 needle bar in the Ready to Sew mode (see pages 29 and 36 of the instruction book) and push the needle bar down.
4. Turn the handwheel to set the index disk at 21°.

NOTE:

To prevent the needle from hitting the hook body, hold the hook with the hook point up while turning the handwheel.

5. Turn the hook to align the hook point with the right side of the needle (use DBxK5Q1NY needle).

NOTE:

Maintain a clearance between the needle and hook point within 0.05 – 0.20 mm.

6. Tighten the three setscrews securely.
7. Check the position of the hook stopper (see page xx).

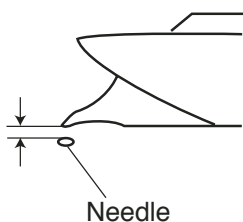
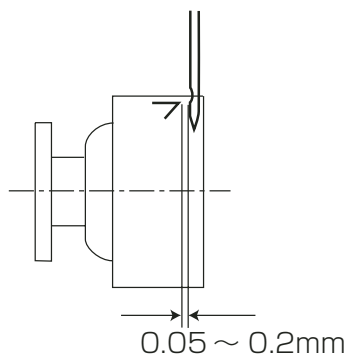
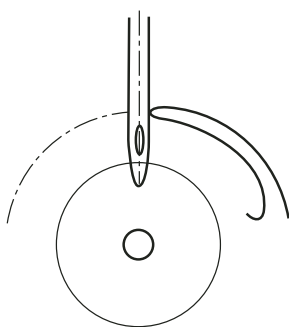
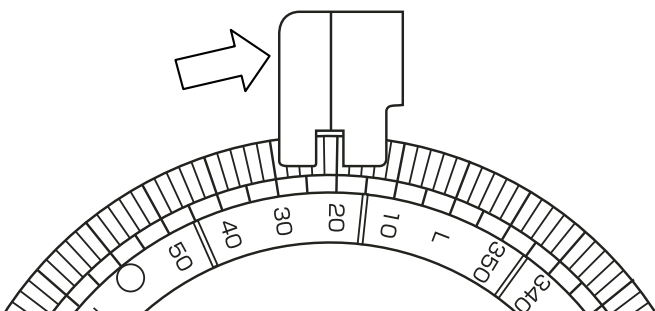

Adjusting the Position of the Hook Stopper

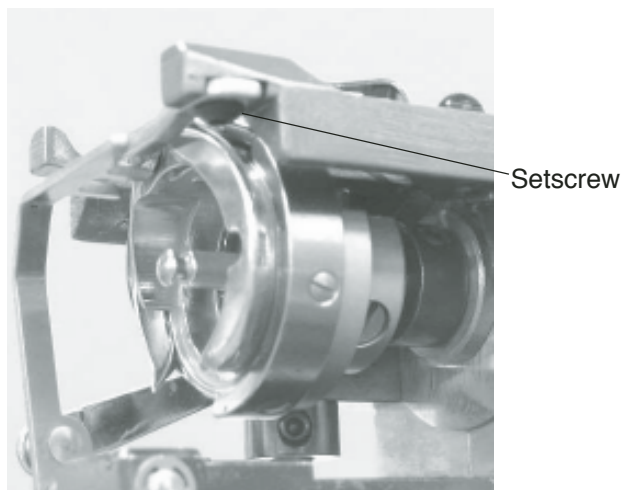

1. Loosen the setscrew to move the hook stopper.
2. Move the hook stopper to align the center with the needle and make a 0.6 – 0.8 mm clearance between the hook.
Tighten the setscrew securely.

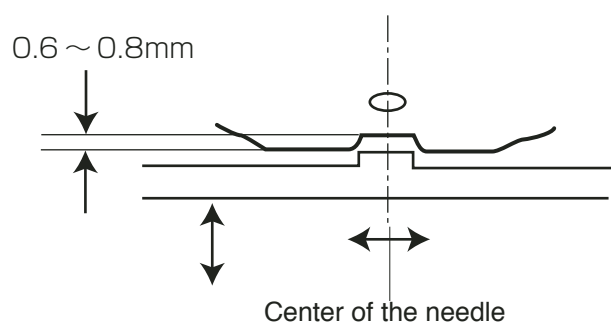
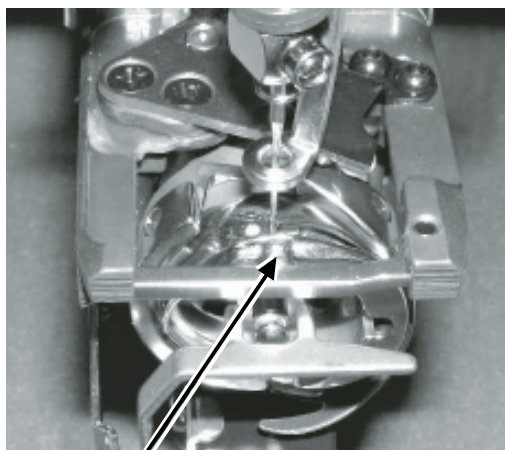

Replacing the Thread Cutter Driving Roller

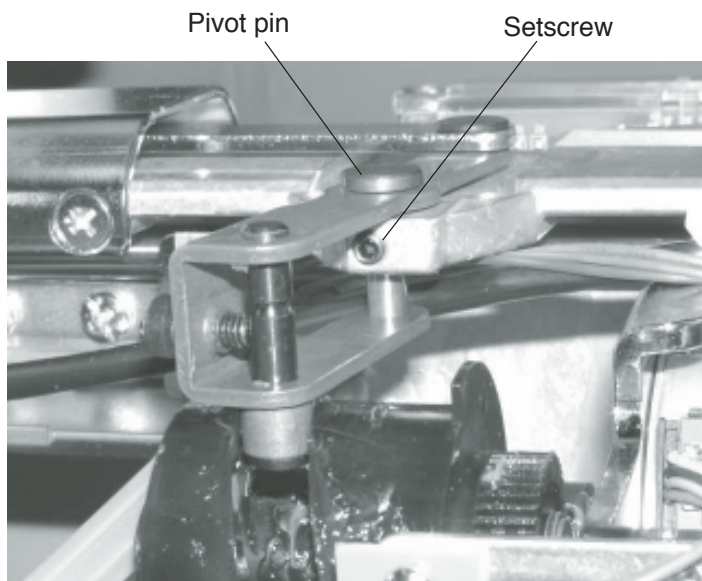

1. Remove the spool stand, static head cover (right) and right cover (see pages 4 – 6).
2. Loosen the setscrew and remove the pivot pin. Remove the lever unit from the frame.
3. Loosen the setscrew and remove the roller shaft. Replace the thread cutter driving roller.
4. Insert the 0.05 mm thick gauge between the lever unit and thread cutter driving roller. Tighten the setscrew securely.
5. Attach the lever unit to the frame and insert the pivot pin. Tighten the setscrew securely.
6. Adjust the position of the dynamic cutter blade (see page 37).
7. Attach the parts remove in step 1.

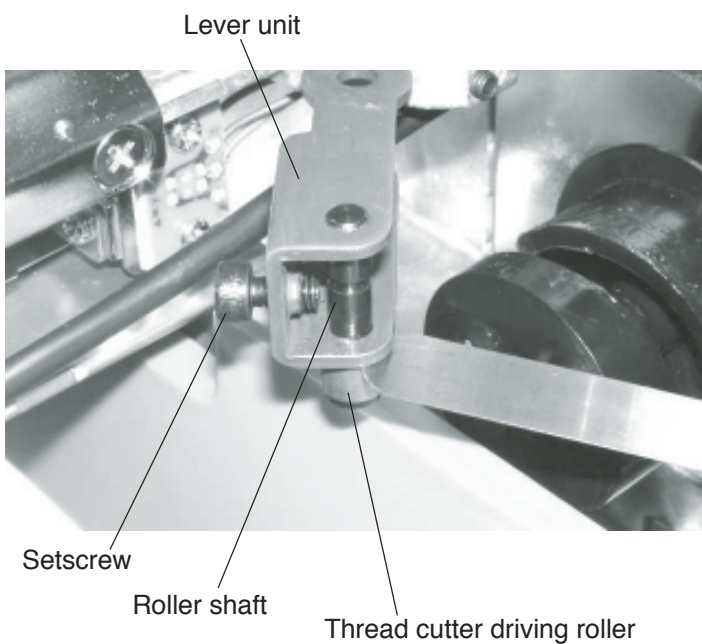

Replacing the Dynamic Cutter Blade

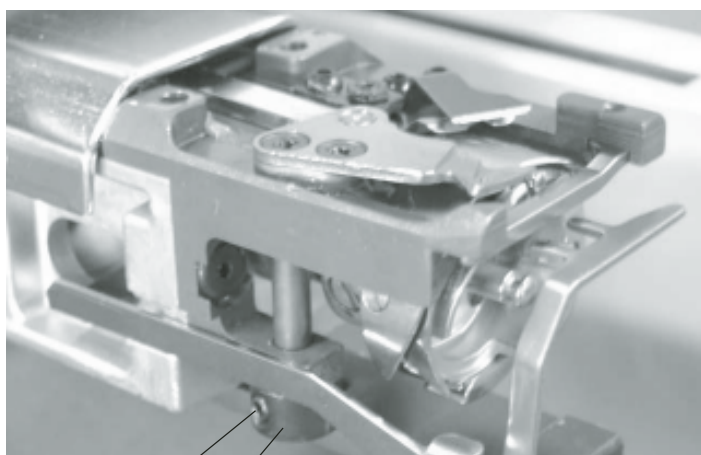
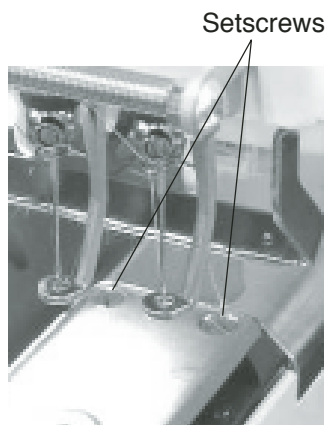

Setscrew
Drive shaft ring

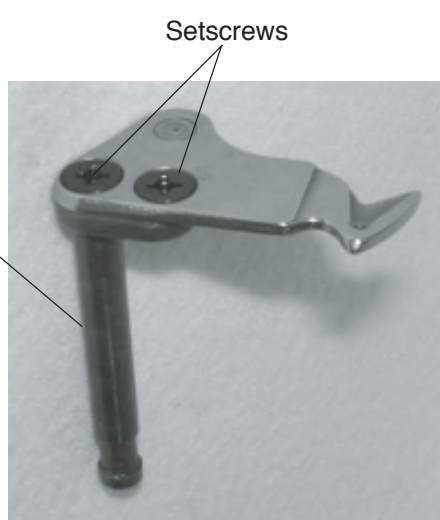

Drive shaft unit

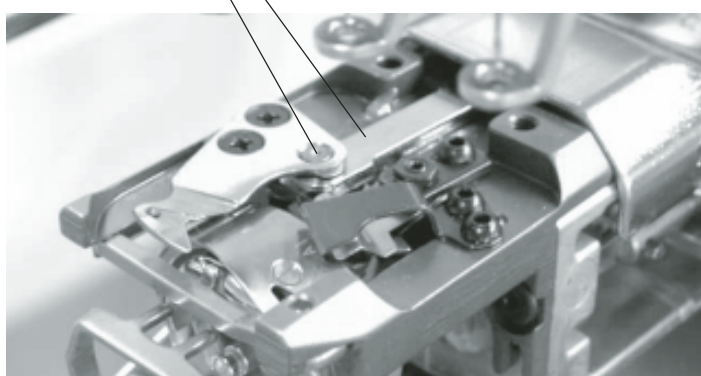

1. Remove the 2 setscrews and needle plate.
 2. Turn the power switch on while pressing the Start/ Stop button and Thread cutter button at the same time to open the **Factory Adjusting** window. Press the **Phase** key to open the **Phase Sensor** adjusting window and press the **All Init** key. Press the **Cancel** key to return to the previous window. Press the **Cut Motor** key to open the **Cut Motor** adjusting window. Press **Divide** key to move the dynamic cutter blade forward.
 3. Loosen the 2 setscrews and remove the drive shaft ring.
 4. Remove the cutter drive shaft unit from the frame. Remove the two setscrews and replace the dynamic cutter blade.
 5. Insert the drive shaft into the frame and link pin of the cutter drive shaft unit into the hole in the lever unit.
 6. Attach the drive shaft ring and tighten the 2 setscrews while pressing the ring and shaft unit each other with your fingers.
- NOTE:**
Be sure that there is no thrust play in the shaft unit.
7. Adjust the cutter blades position (see following pages 39 and 40) and test auto thread cutting.
 8. Attach the needle plate.

Replacing the Static Cutter Blade

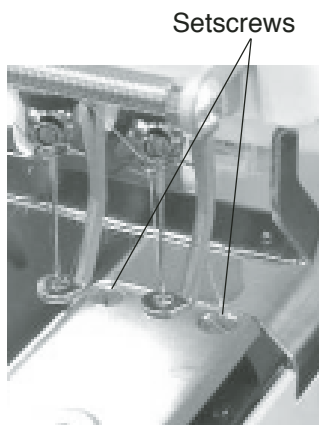

1. Remove the setscrews and needle plate.
2. Press **Divide** key to move the dynamic cutter blade forward.
3. Remove the two setscrews and replace the static cutter blade.
4. Attach the static cutter blade and tighten the set screws while pressing the static cutter blade in the direction of the arrow.

NOTE:

If the dynamic cutter blade interferes with the left corner of the static cutter blade when moving the dynamic cutter blade, shift the static cutter blade to the right.

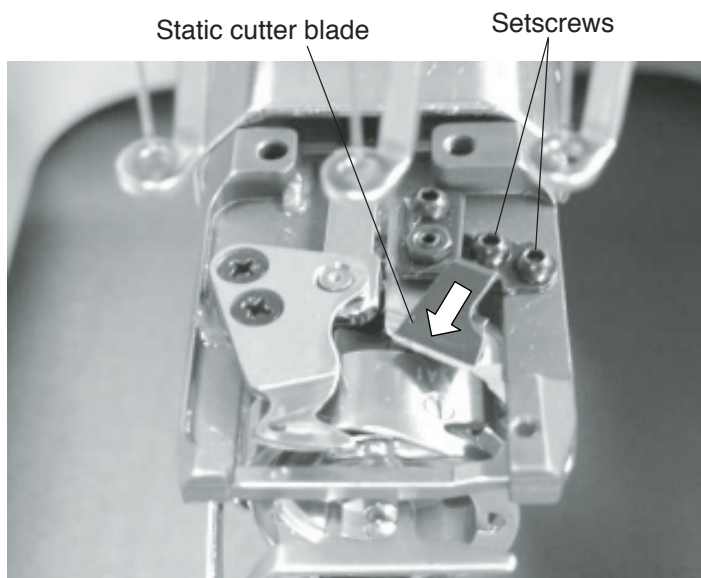

5. Adjust the cutter blades position (see following pages 39 and 40) and test auto thread cutting.
6. Attach the needle plate.

Adjusting the Static Cutter Blade

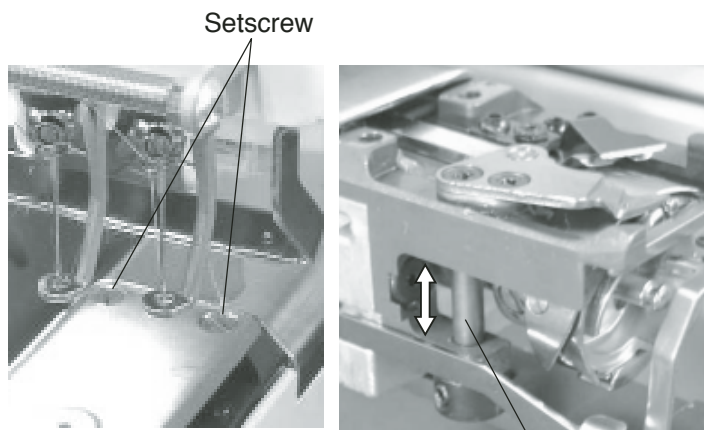

Upper adjusting screw

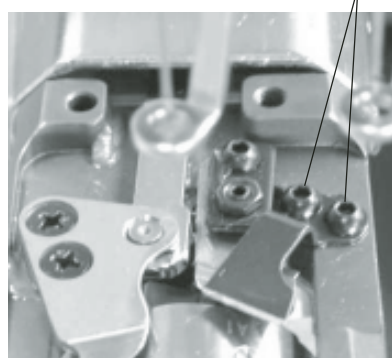

Cutter drive shaft

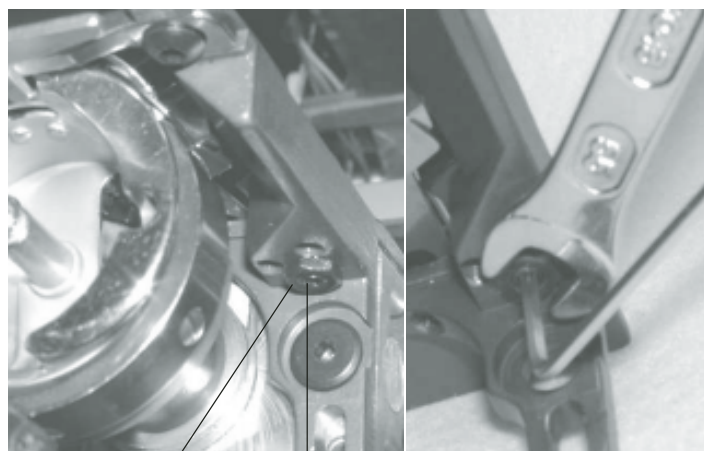

Nut

Lower adjusting screw



1. Remove the 2 setscrews and needle plate.
2. Press **Init** key to move the dynamic cutter blade to the home position.
3. Check if there is no play in the cutter drive shaft and eliminate a play if any.
4. The front tip of the dynamic cutter blade should extend 0.3 to 0.5 mm from the edge of the static cutter blade.
If there is a gap between the edge of the static cutter blade and the dynamic cutter blade, adjust the height of the static cutter blade.
Loosen slightly the two setscrews and nut on the adjusting screw. Screw in the adjusting screw until the edge of the static cutter blade evenly touches the upper surface of the dynamic cutter blade.
Tighten the two setscrews and nut.
5. Test auto thread cutting with polyester threads size #120 both in the needle and bobbin.
6. Attach the needle plate.

Adjusting the Dynamic Cutter Blade

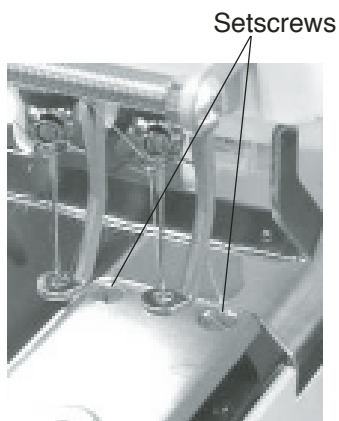

1. Remove the spool stand, static head right cover, right cover and left cover (see pages 4 – 6).
2. Remove the two setscrews and needle plate.
3. Press **Divide** key to move the dynamic cutter blade to the home position.

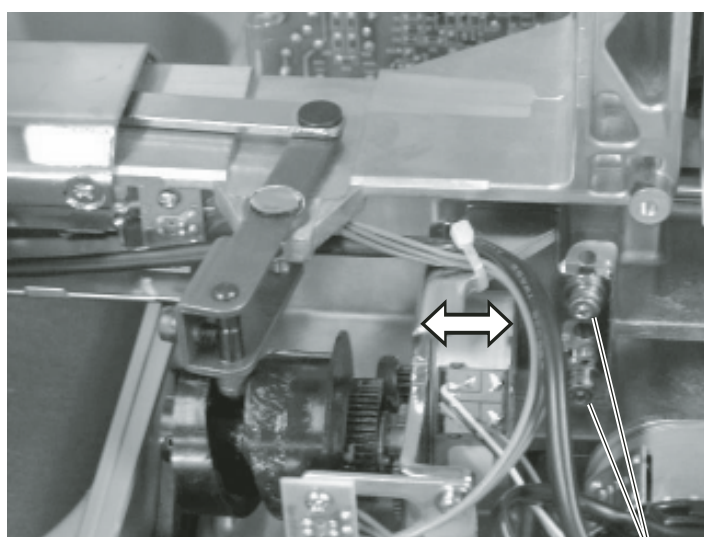

4. Loosen the two setscrews and move the thread cutter drive unit in the direction of the arrow to adjust the position of the dynamic cutter blade so the front tip of the dynamic cutter blade is in line with the center of the needle drop position.
5. Test auto thread cutting with polyester threads size #120 both in the needle and bobbin.
6. Attach the needle plate.
7. Attach the parts removed in step 1.

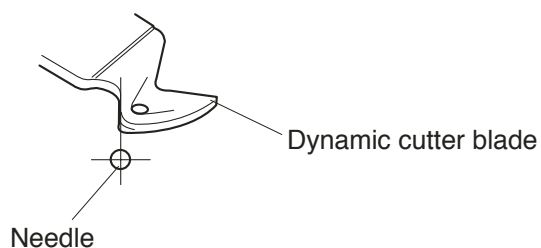

Adjusting the Bobbin Thread Holder

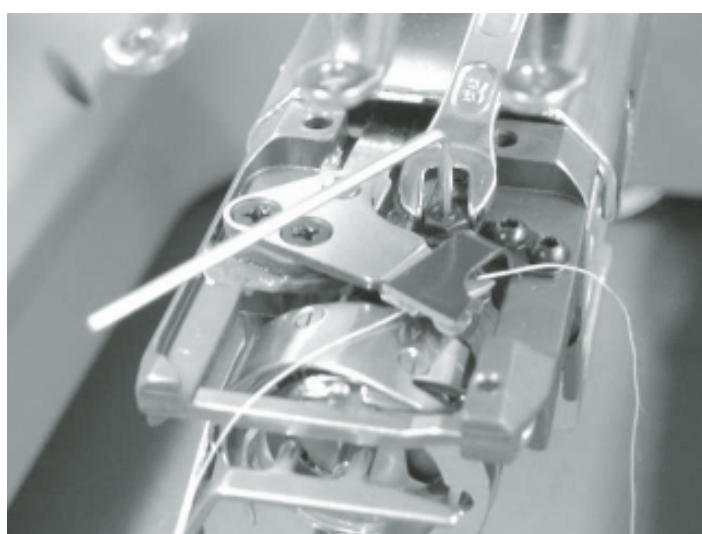
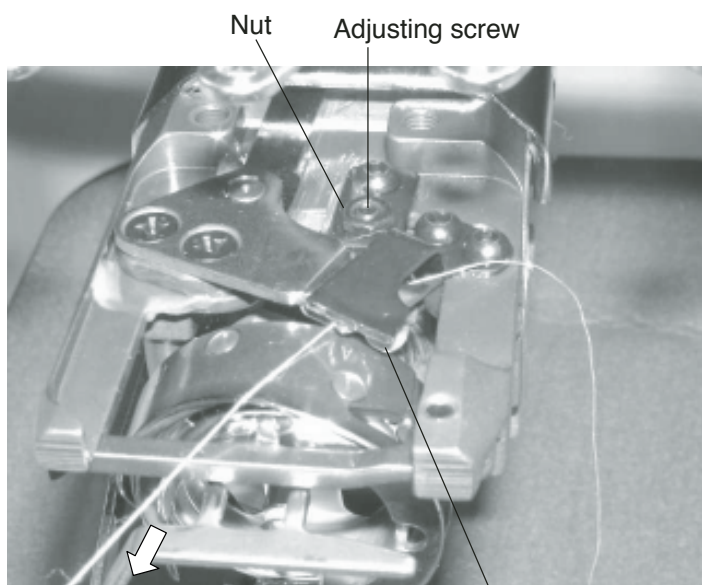
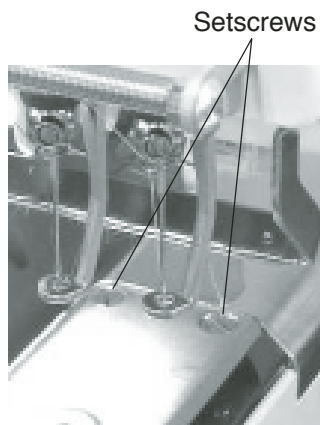

1. Remove the 2 setscrews and needle plate.
2. Place the bobbin thread between the dynamic cutter blade and bobbin thread holder. Close the dynamic cutter blade to clamp the bobbin thread.
3. Loosen the nut and turn the adjusting screw to adjust the clamping pressure.
4. Pull the bobbin thread with a tension gauge and read the tension when the bobbin thread is coming out. The tension should be 20 – 25 grams. Check the tension several times.
5. Tighten the nut while holding the adjusting screw in place.
6. Attach the needle plate.

Adjusting the Thread Keeper

Gauge (770-902-009)

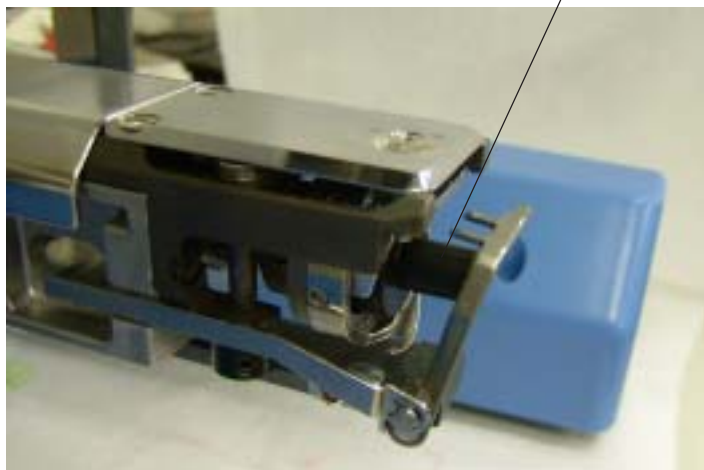

1. Insert the gauge (770-902-009) into the hook.
2. Loosen the 2 setscrews (A) and insert a 2 mm thick gauge between the frame of the solenoid and washer on the plunger.
3. Slide the solenoid in the direction of the arrow until the tips of the thread keeper touch the gauge. Tighten the 2 setscrews (A) securely.

NOTE:

The clearance between the bobbin and the tips of the thread keeper should be 1.4 - 1.8 mm.

Thread keeper solenoid

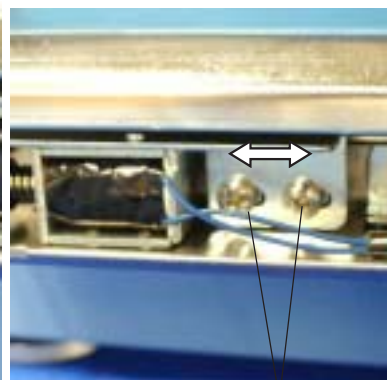
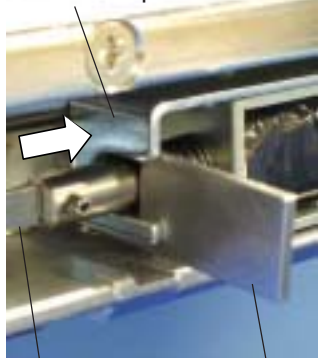

2 mm thick gauge (770-901-008) Setscrews (A)

4. Loosen the setscrew (B) and move and press the stopper against the thread keeper rod. Remove the 2 mm thick gauge and push the thread keeper toward the gauge to check if the tips of the thread keeper touches the gauge.
5. Tighten the setscrew (B) securely.
6. Attach the needle plate.

Gauge (770-902-009)

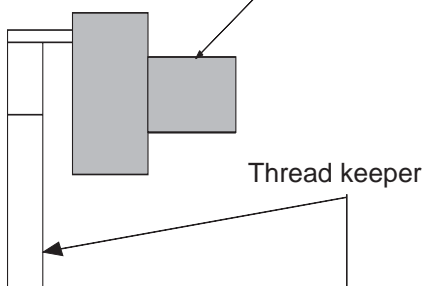

Setscrew (B)

Stopper

Adjusting the X-carriage Belt Tension

X-carriage cover

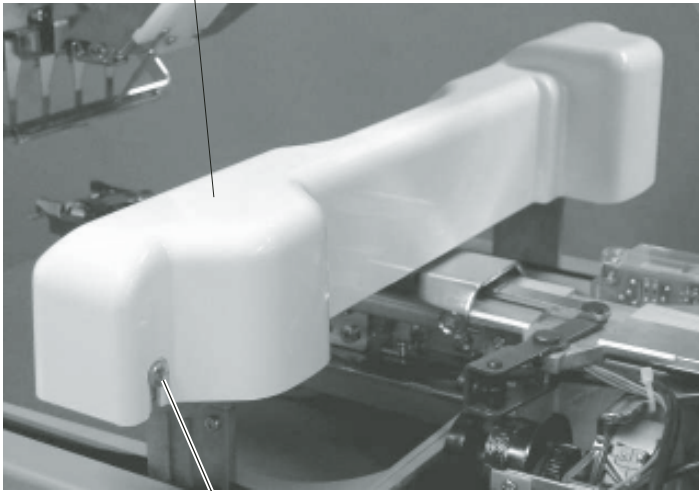

Setscrews (A)

Push-pull gauge

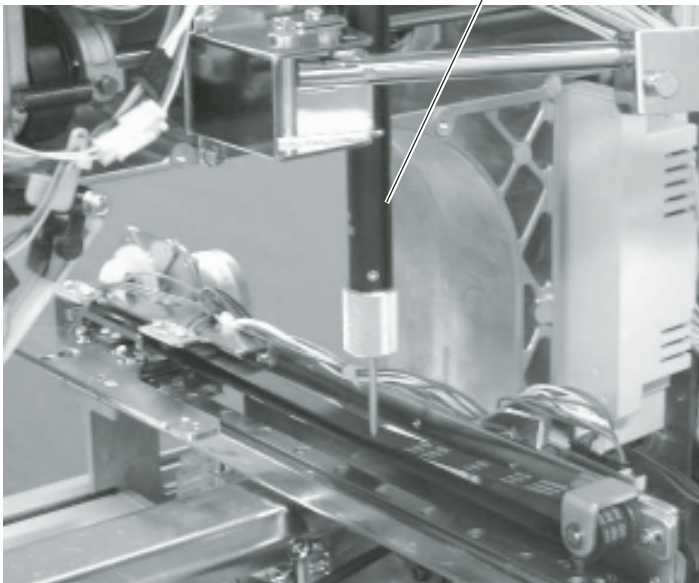

Side hole

X-belt pulley

Setscrews (B)

Base plate

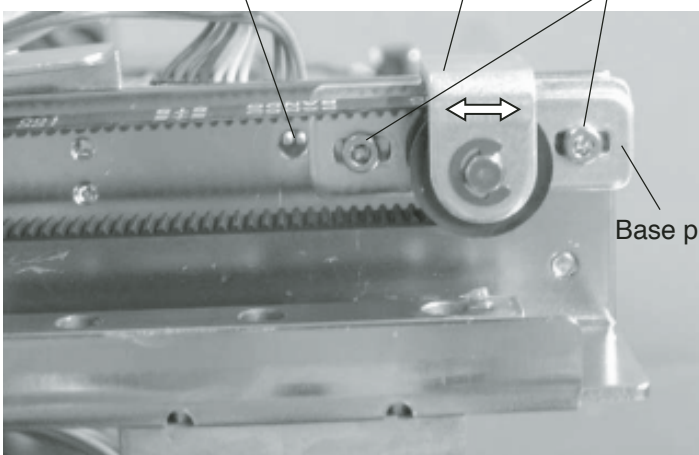

1. Remove the spool stand, static head right cover, right cover and left cover (see pages 4 – 6).
2. Loosen the 2 setscrews (A) and remove the X-carriage cover.
3. Shift the hoop supporter to the extreme left end. Set the push-pull gauge at the right side of the machine frame and push the X-carriage timing belt. The gauge should read 600 grams when the upper portion touches the lower portion.
4. If the belt tension is too tight or loose, slightly loosen the 2 setscrews (B) and move the X-belt pulley in the direction of the arrow to adjust the belt tension. Tighten the 2 setscrews (B) securely and check the tension again.

NOTE:

When moving the X-belt pulley, insert a 4 mm rod into the side hole and pry the base plate of the pulley.

5. Attach the X-carriage cover with the 2 setscrews (A).
6. Attach the parts removed in step 1.

Replacing the X-carriage Belt

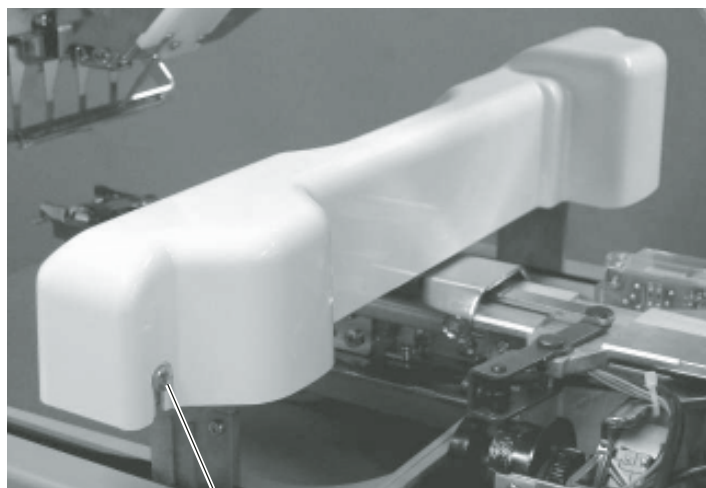

Setscrews (A)

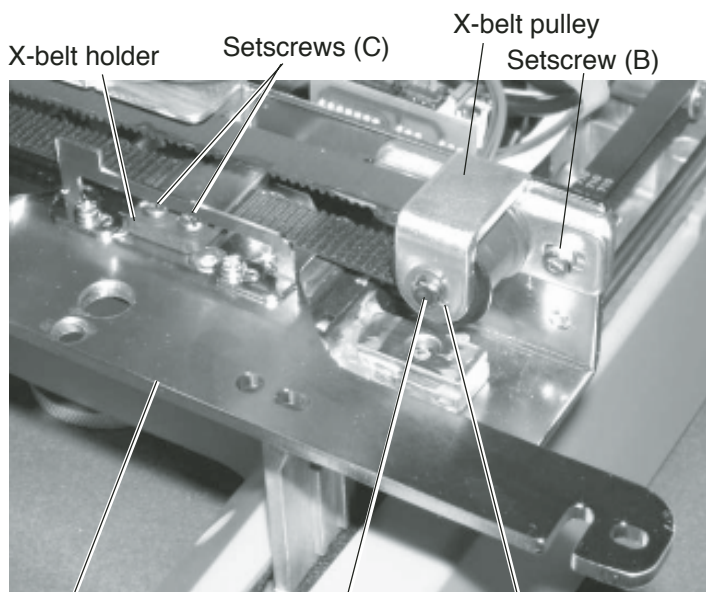

X-belt holder

Setscrews (C)

X-belt pulley

Setscrew (B)

Hoop supporter

X-belt pulley shaft

E-ring

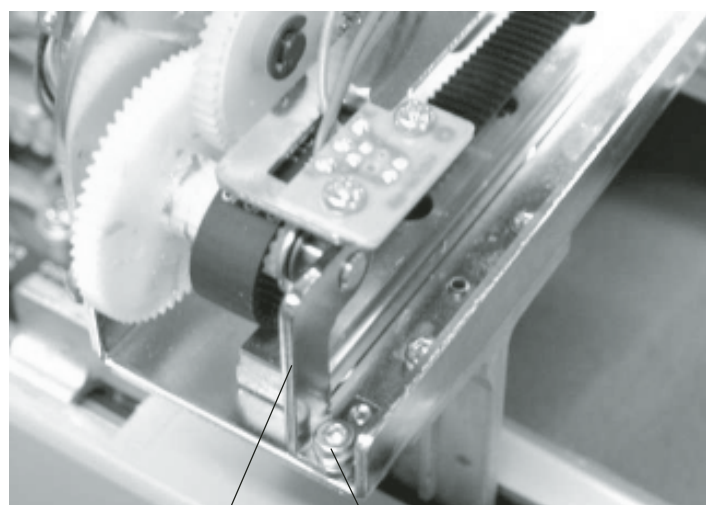

Drive pulley shaft unit

Setscrews (D)

1. Remove the spool stand, static head right cover, right cover and left cover (see pages 4 – 6).
2. Loosen the 2 setscrews (A) and remove the X-carriage cover.
3. Shift the hoop supporter to the extreme right end. Remove the 2 setscrews (C) and the X-belt holder.
4. Loosen the 2 setscrews (B) and shift the X-belt pulley to the left.
5. Remove the E-ring and pull the X-belt pulley shaft to remove the X-belt pulley.
6. Remove the setscrew (D) and drive pulley shaft unit.
7. Replace the X-carriage belt.
8. Attach the parts removed in steps 3 – 6.
9. Adjust the X-carriage belt tension (see the previous page).
10. Attach the parts removed in steps 1 – 2.

Adjusting the Y-carriage Belt Tension

1. Remove the spool stand, static head right cover, high cover and left cover (see pages 4 – 6).
2. Shift the X-carriage to the extreme front end.
3. Set the push-pull gauge in line with the front end of the base frame and push the Y-carriage timing belt. The gauge should read 280 grams when the upper portion touches the lower portion.
4. If the belt tension is too tight or loose, slightly loosen the 2 setscrews (A) and move the Y-belt pulley in the direction of the arrow to adjust the belt tension. Tighten the tow setscrews (A) securely and check the tension again.
5. Attach the parts removed in step 1.

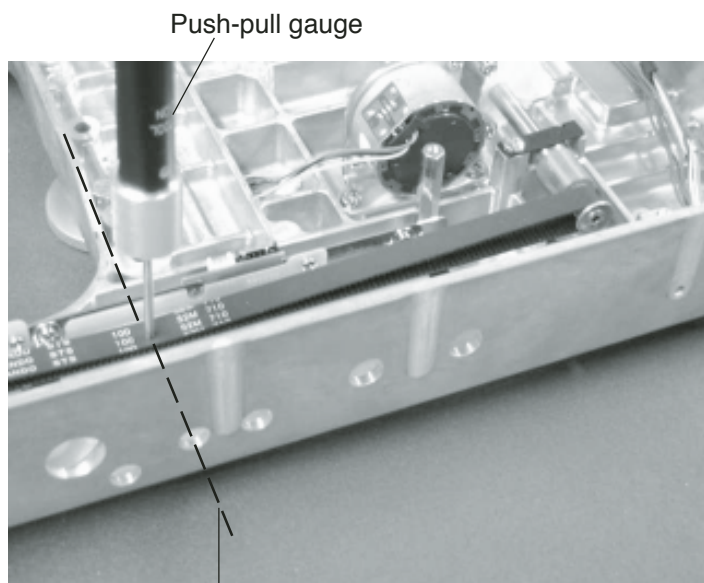

Push-pull gauge

Front end of the base frame

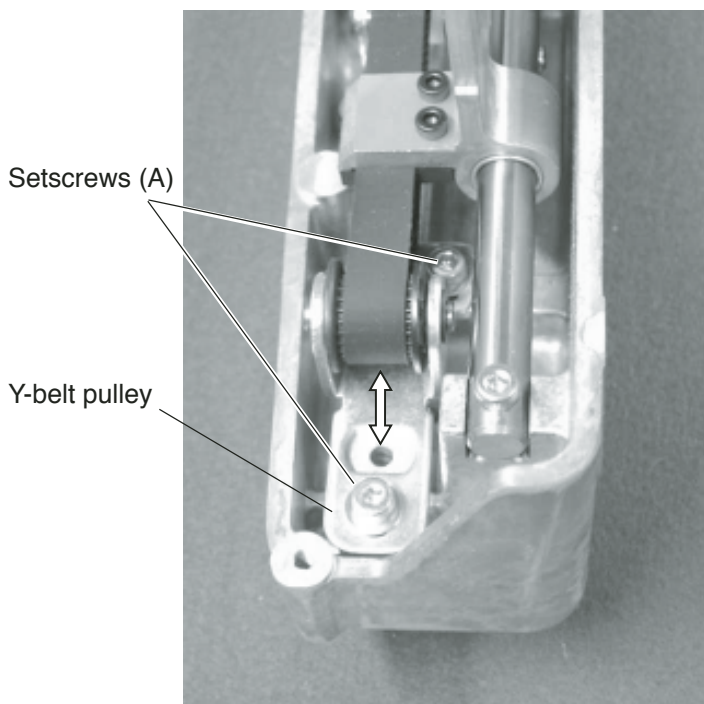

Setscrews (A)

Y-belt pulley

Replacing the Y-carriage Belt

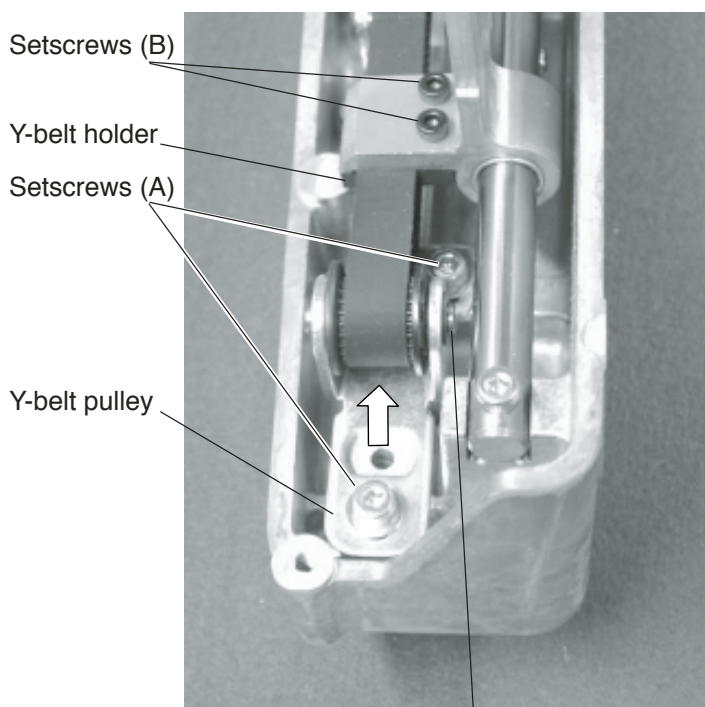

Setscrews (B)

Y-belt holder

Setscrews (A)

Y-belt pulley

E-ring
Y-belt pulley shaft

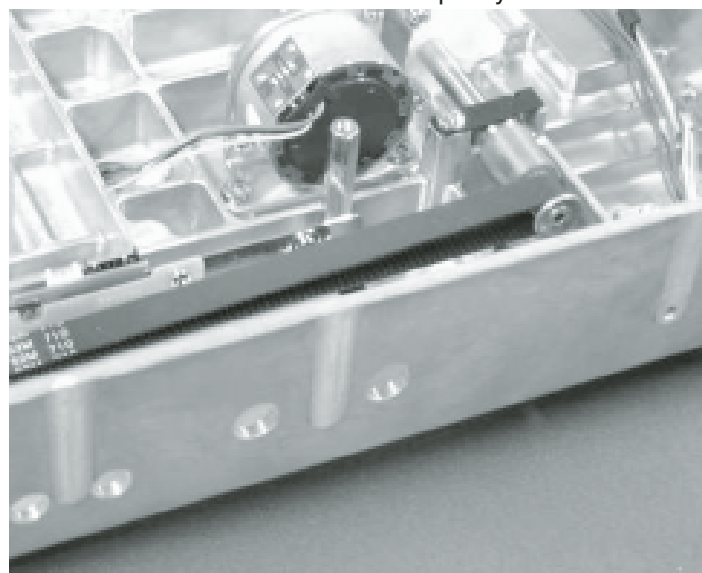

1. Remove the spool stand, static head right cover, right cover and left cover (see pages 4 – 6).
2. Remove the 2 setscrews (B) and the Y-belt holder.
3. Loosen the 2 setscrews (A) and shift the Y-belt pulley in the direction of the arrow.
4. Remove the E-ring and pull the Y-belt pulley shaft to remove the Y-belt pulley.
5. Replace the Y-carriage belt.
6. Attach the parts removed in steps 2 – 5.
7. Adjust the Y-carriage belt tension (see the previous page).
8. Attach the parts removed in step 1.

Adjusting the Timing Belt Tension

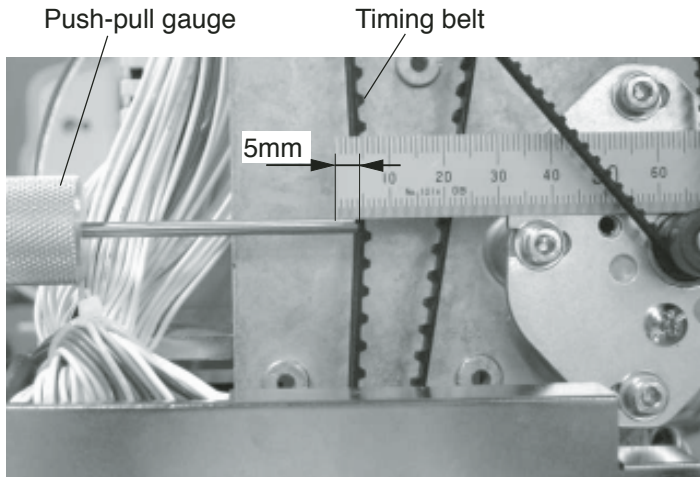

1. Remove the spool stand, static head right cover and left cover (see pages 4 – 6).
2. Place a scale on the DC motor. Set the push-pull gauge in line with the scale as illustrated and push the timing belt. The gauge should read 300 grams when the belt deflect 5 mm.
3. If the belt tension is too tight or loose, remove the 3 setscrews (A) and CPU board, then slightly loosen the 2 setscrews (B) and move the idler in the direction of the arrow to adjust the belt tension. Tighten the 2 setscrews (B) securely and check the tension again.
4. Attach the parts removed in step 1.

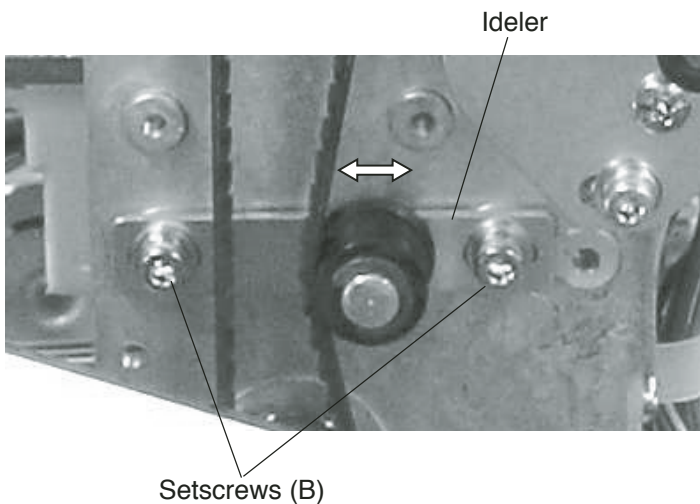
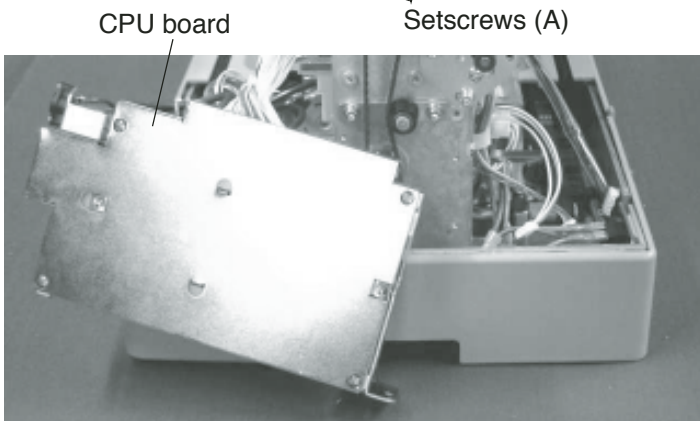
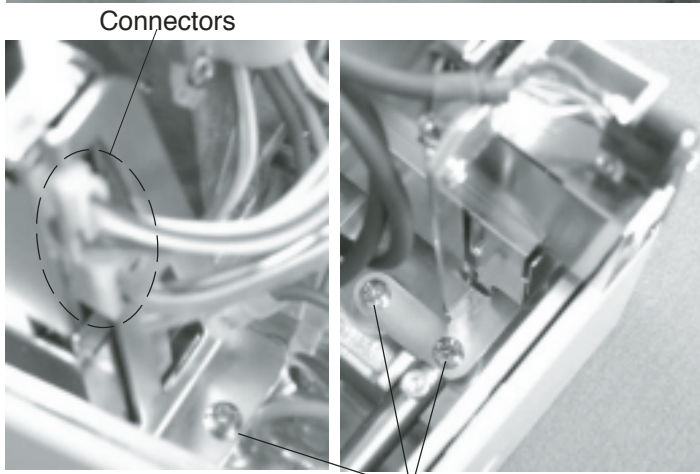

Replacing the Timing Belt

1. Remove the spool stand, static head right cover, right cover and left cover (see pages 4 – 6).
2. Remove the 2 setscrews (A) and the pointer.
3. Remove the 3 setscrews (B) and CPU board.
4. Remove the motor belt (see page 50).
5. Loosen the 2 setscrews (C) and remove the idler.
6. Replace the timing belt.
7. Attach the parts removed in steps and 5.
8. Adjust the timing belt tension (see the previous page).
9. Check the following items and adjust them if necessary.
 - Needle bar lowest position
 - Hook timing
 - Thread cutter timing
10. Attach the parts removed in steps 1 – 3.

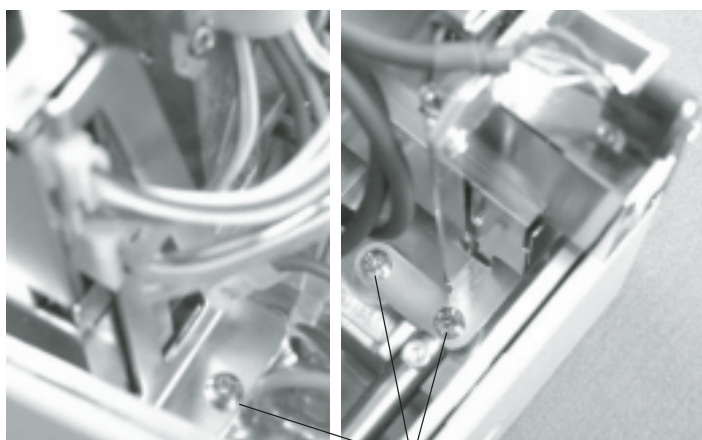
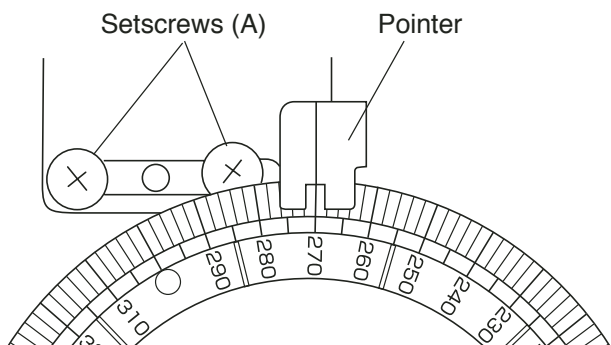

CPU board

Setscrews (B)

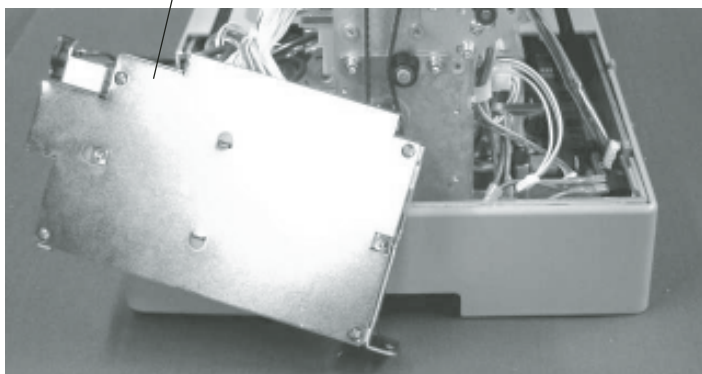

Timing belt

Idler

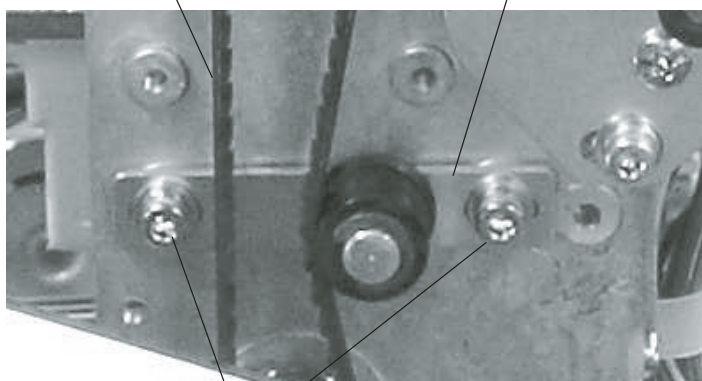

Setscrews (C)

Adjusting the Motor Belt Tension

1. Remove the spool stand, static head right cover, right cover and left cover (see pages 4 – 6).
2. Place a scale under the stud bolt. Set the push-pull gauge in line with the scale as illustrated and push the timing belt. The gauge should read 300 grams when the belt deflect 3 mm.
3. If the belt tension is too tight or loose, slightly loosen 3 setscrews and move the motor in the direction of the arrow to adjust the belt tension. Tighten the 3 setscrews securely and check the tension again.
4. Attach the parts removed in step 1.

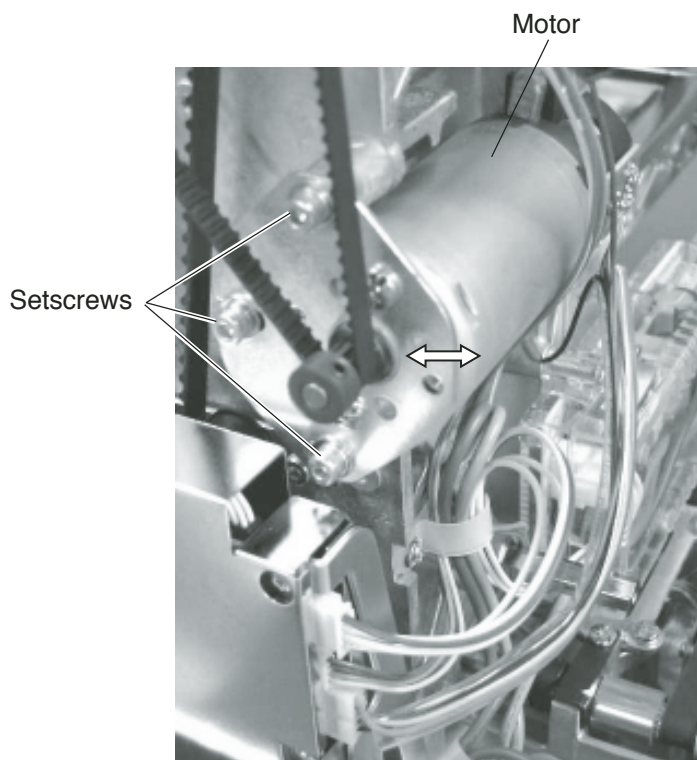
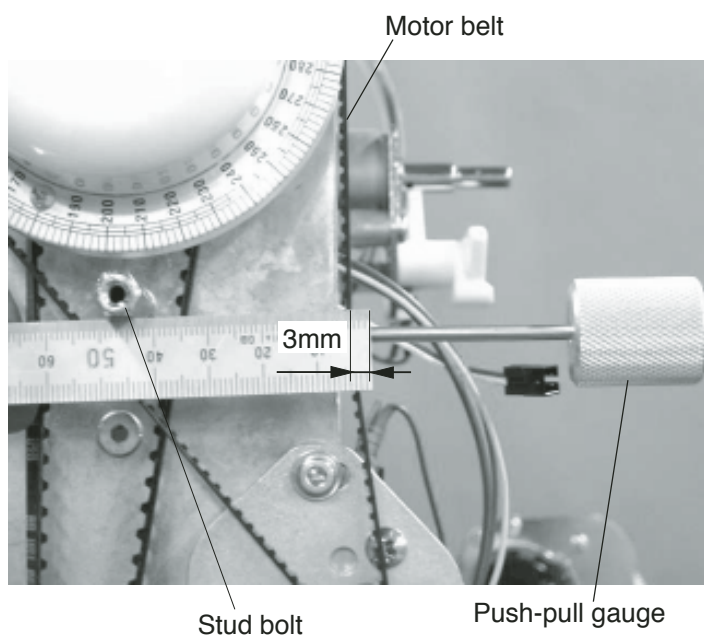

Replacing the Motor Belt

1. Remove the spool stand, static head right cover, right cover and left cover (see pages 4 – 6).
2. Remove the 2 setscrews (A) and the pointer.
3. Remove the three setscrews (B) and DC motor.
4. Replace the motor belt. Attach the motor and motor belt.
5. Adjust the motor belt tension (see the previous page).
9. Attach the parts removed in step 1.

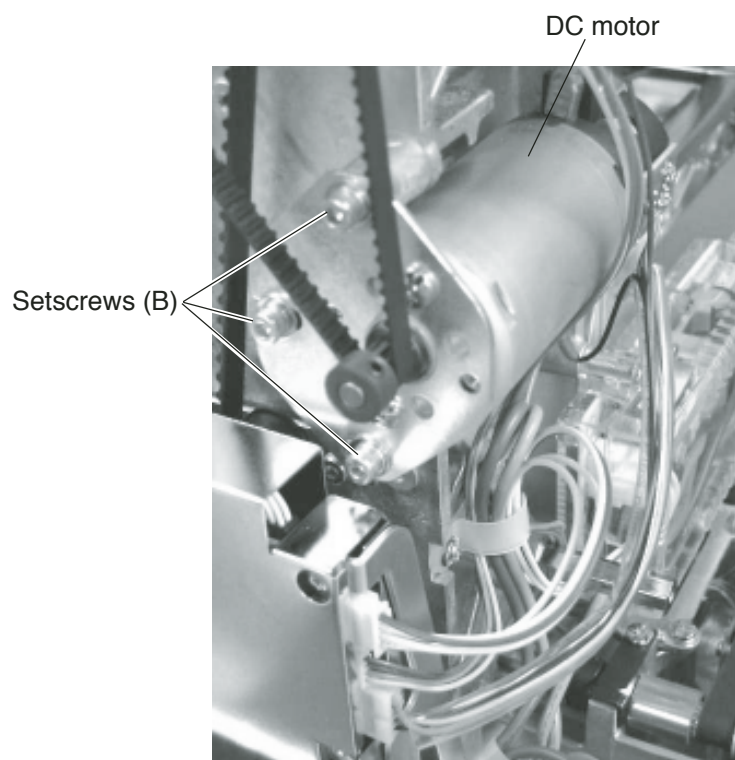
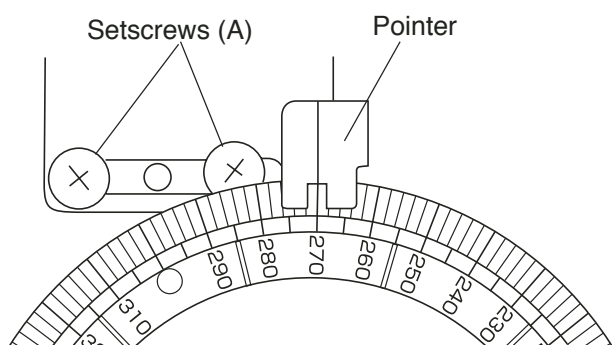

Replacing the DC Motor

1. Remove the spool stand, static head right cover, right cover and left cover (see pages 4 – 6).
2. Disconnect the motor connector. Remove the 3 setscrews (A) and DC motor.
3. Attach the DC motor and tighten the 3 setscrews (A) slightly. Connect the motor connector.
4. Adjust the motor belt tension (see page 49).
5. Attach the parts removed in step 1.

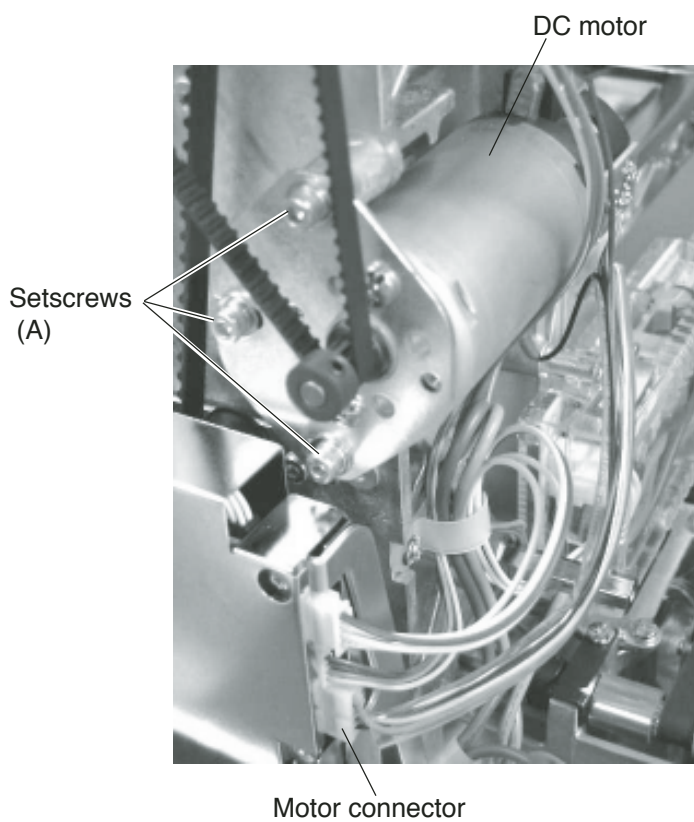

Adjusting the Upper Shaft Timing

1. Remove the spool stand, static head cover (right) and right cover (see pages 4 and 6).

2. Open the factory adjusting menu window and press the **Phase** key to open the **Phase Sensor** adjusting window.

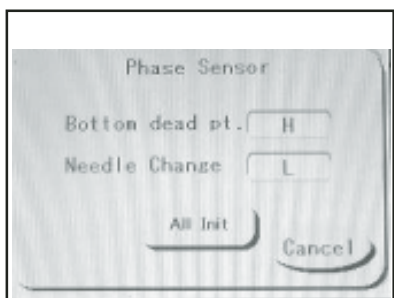

3. Turn the handwheel clockwise. The indication next to **Bottom dead pt.** should change from "L" to "H" when the index disk is set at 0° (L).

To adjust the bottom dead point (lowest position of the needle) timing, loosen the setscrew on the lowest position shield plate and turn it clockwise until the indication changes from "L" to "H". Tighten the set screw.

4. Turn the handwheel clockwise. The indication next to **Needle Change** should change from "L" to "H" when the index disk is set at 270°.

To adjust the needle change position timing, loosen the setscrew on the C point (needle change) shield plate and turn it clockwise until the indication changes from "L" to "H".

Tighten the setscrew.

NOTE:

The shield plates should not interfere with the sensors.

5. Attach the parts removed in step 1.

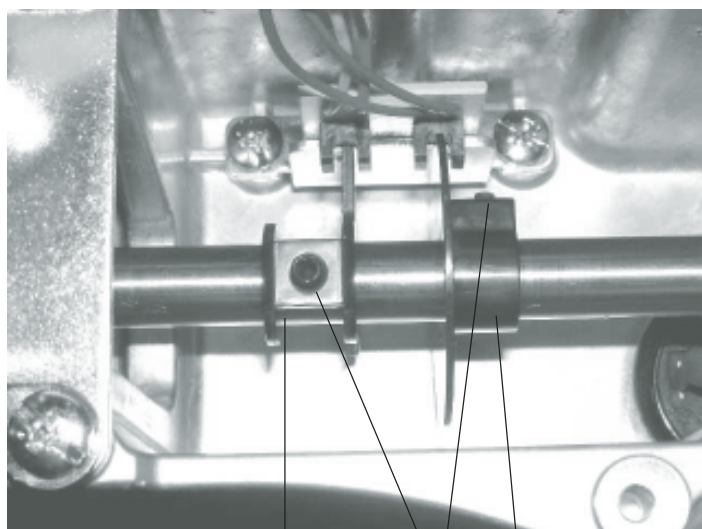
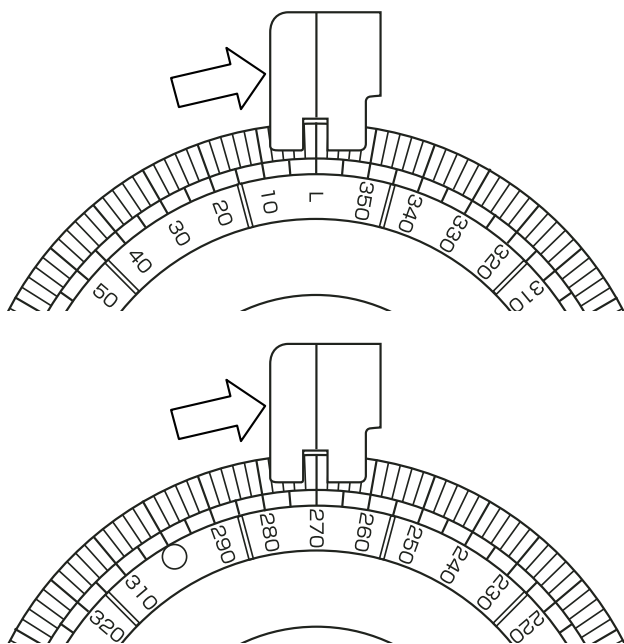

Bottom dead point (lowest position) shield plate

Setscrews

C point (needle change) shield plate

Adjusting the Moving Head Stop Position

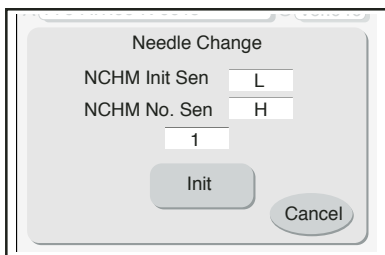

Lateral movement idler gear

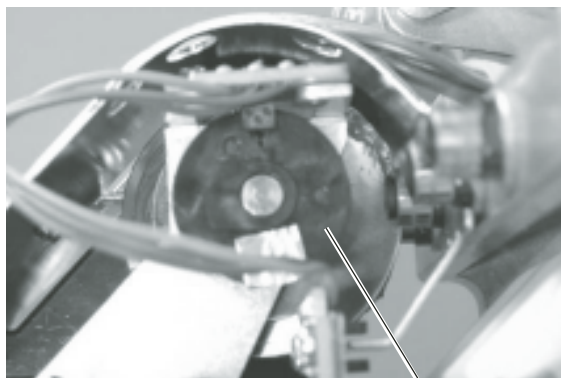
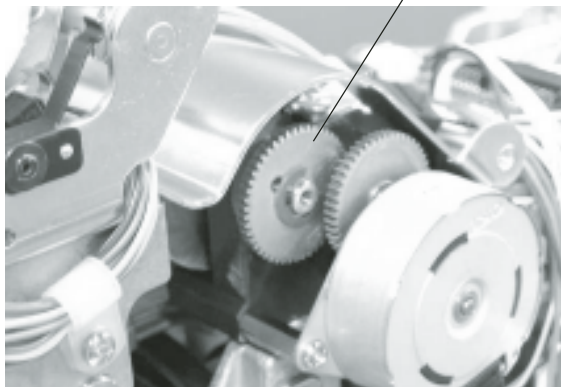

Stop position shield plate

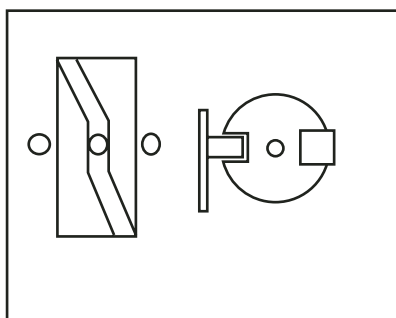

Phase reference of the lateral movement cam and stop position shield plate

Setscrew



1. Remove the spool stand, static head cover (right), right cover, left cover and tension control panel (see pages 4 – 6).
2. Open the factory adjusting menu window and press the **Needle** key to open the **Needle Change** adjusting window.
3. Turn the lateral movement idler gear to set the lateral movement cam at the middle of the flat portion. The indication next to **NCHM No. Sen** should be **“H”**. To adjust the stop position, loosen the setscrew and turn the stop positioning shield plate. Tighten the setscrew.

NOTE:

The shield plate should not interfere with the sensor.

4. Press Init key to move the head to the stop position and check if **“L”** is indicated.
5. Attach the parts removed in step 1.

Adjusting the Needle Stop Position

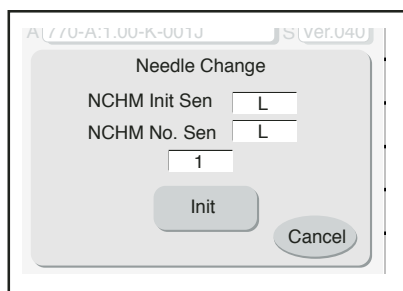

1. Remove the spool stand, static head cover (right), right cover, left cover and tension control panel (see pages 4 – 6).
2. Turn the lateral movement idler gear to select needle bar No. 1.
3. Open the factory adjusting menu window and press the **Needle** key to open the **Needle Change** adjusting window.

Lateral movement idler gear

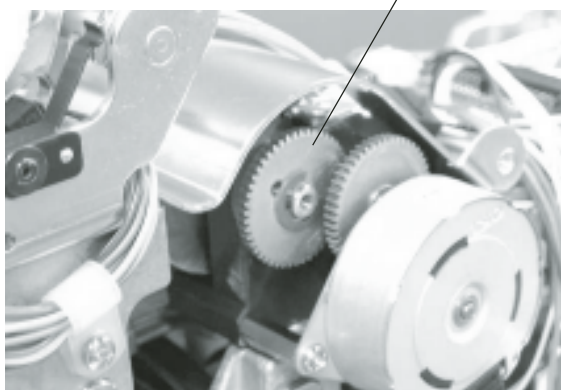

4. Loosen the 2 setscrews.
5. Move the needle stop sensor to the right until the indication next to **NCHM Init Sen** turns "H".
6. Move the needle stop sensor slowly to the left until the indication next to **NCHM Init Sen** turns "L". Tighten the setscrews.

NOTE:

The sensor should not interfere with the home position dog.

7. Attach the parts removed in step 1.

Home position dog

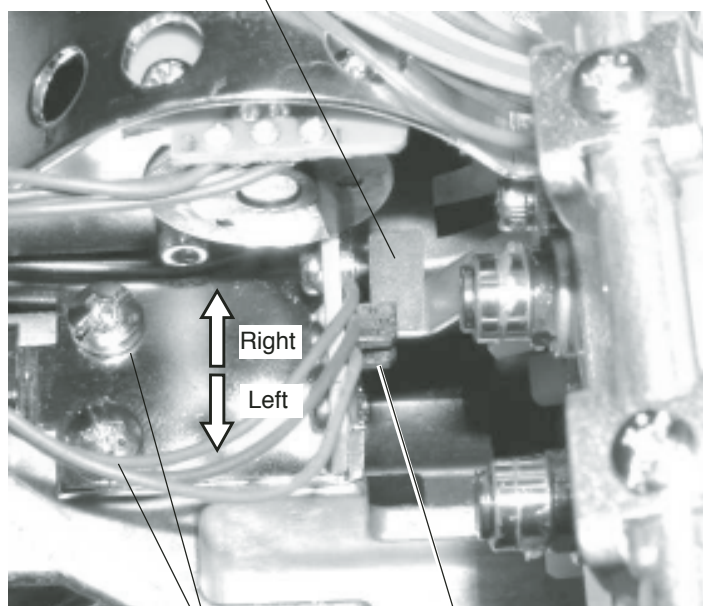

Setscrews

Needle stop sensor

Adjusting the Carriage Home Position (1)

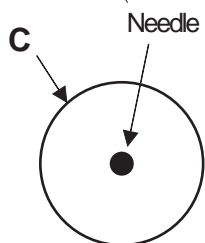
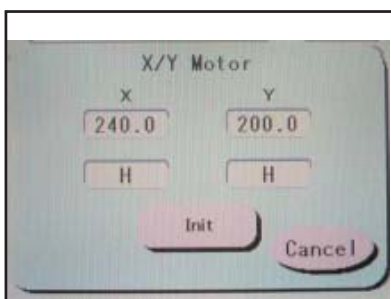
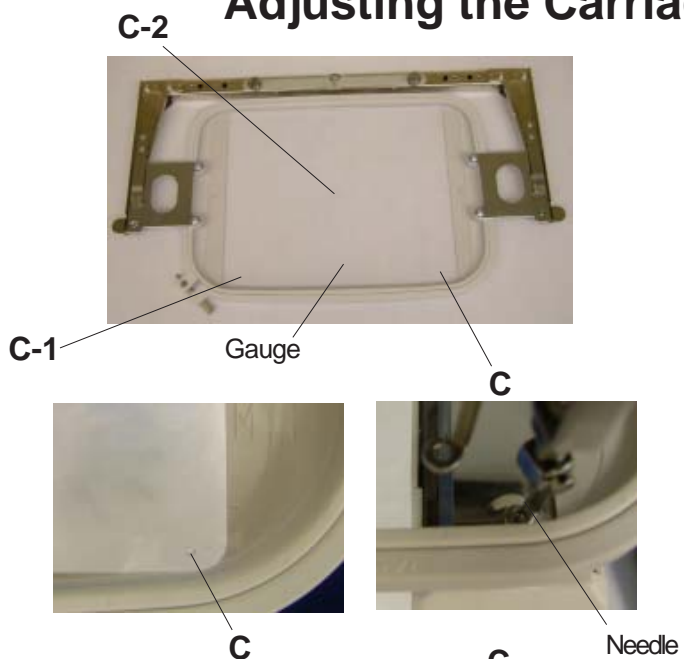

1. Remove the spool stand, right cover, left cover, base cover and X-carriage cover (see pages 4 - 7).
2. Place the Gauge (770-905-002) in the embroidery hoop.
3. Open the factory adjusting menu window. Press the **Phase** key and **All Init** key respectively to initialize the carriage position. Press **Cancel** key. Press the **X/Y Motor** key to open the **X/Y Motor** adjusting window.
4. Lower the needle bar. Adjust the y-carriage sensor plate so the needle is positioned the center of the hole C.
5. Loosen the two setscrews (A) slightly. Move the Y-carriage sensor plate slowly to the front until the indication under Y changes from "H" to "L". Tighten the two setscrews (A).
6. Loosen the two setscrews (B) slightly. Move the X-carriage sensor plate slowly to the left until the indication under X changes from "H" to "L". Tighten the two setscrews (B).

NOTE:

The sensors should not interfere with the carriage.

7. Press **Init** key to initialize the carriage position. Check if the needle drop position is the center of the hole.
8. Press the jog key. Position the hole C-1 to the needle drop position (X=0.0 : Y=200.0). Check if the needle drop position is the center of the hole C-1.
- * If the hole C-1 is not centered, adjust the position by turning the timing belt pulley.
9. Press the home position key. Position the hole C-2 to the needle drop position (X=120 : Y=100). The needle drop position should be the center of the hole C-2.

10. Attach the removed parts.



Jog buttons

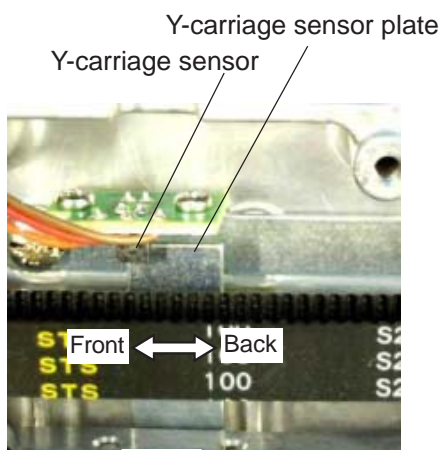

Y-carriage sensor plate

Y-carriage sensor

Front ← Back

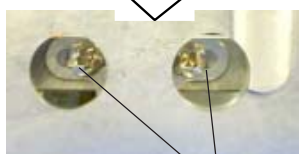

Setscrews (A)

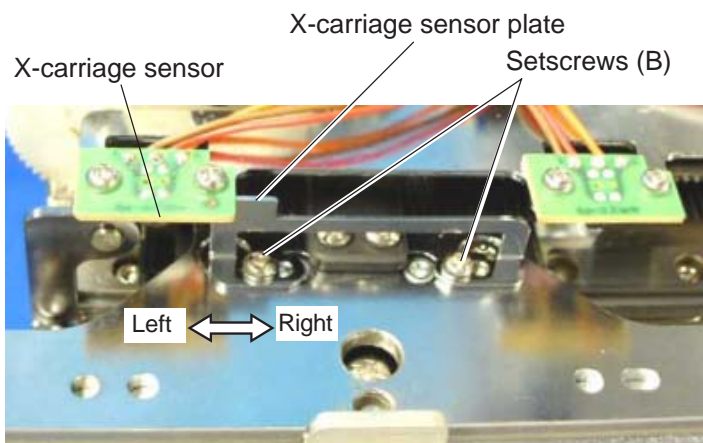

X-carriage sensor plate

X-carriage sensor

Setscrews (B)

Left ↔ Right

Adjusting the Carriage Home Position (2)

Gauge (770-905-002)



C-1

C

Hexagonal socket screws (D)

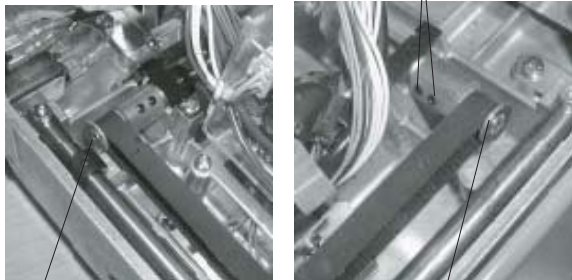

Timing belt pulley (left) Timing belt pulley (right)

[A] X-axis adjustment

When the needle drop position C-1 is not centered although the needle drop position C is centered.

1. Move the carriage with your hand.
Loosen the 2 hexagonal socket screws.
 2. Adjust the needle drop position by turning the timing belt pulley (right).
- * Insert the screwdriver into the timing belt pulley (left) when turning the timing belt pulley (right) so that the timing belt pulley (left) will not turn.
 - * Confirm the adjustment of carriage home position sensor (1).

[B] Y-axis adjustment

When the needle drop position C-1 is not centered although the needle drop position C is centered.

- 1 Loosen the 2 setscrews A.
Remove the X-carriage sensor plate.
 - 2 Loosen the 2 hexagonal socket screws B.
 - 3 Move the carriage to the right with your hand.
Loosen the hexagonal socket C.
 - 4 Adjust the position by moving the connecting plate to the direction of arrow.
 - 5 Tighten the hexagonal socket screw E.
 - 6 Tighten hexagonal socket screws B.
- * Confirm the adjustment of carriage home position sensor (1)

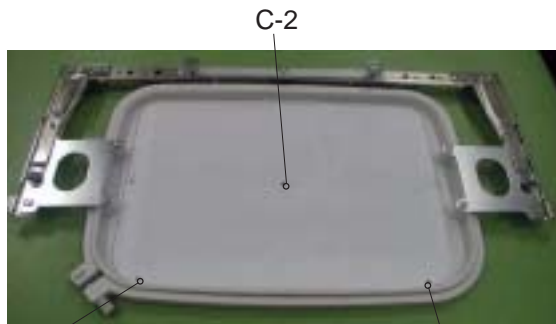

C-2

C-1

C

Carriage sensor plate

Hexagonal socket screws B

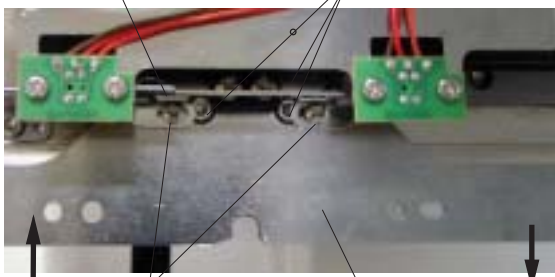

Setscrews A

Connecting plate

Hexagonal socket screws E

