

Reflow-Soldering Systems

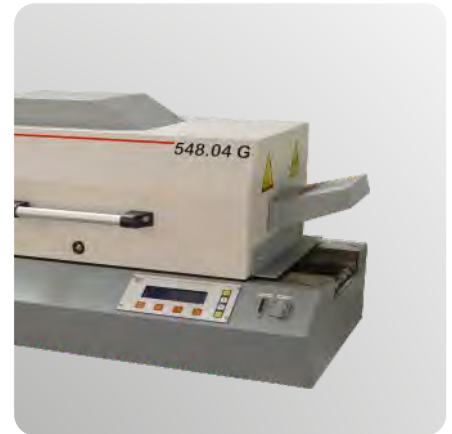

- Free standing models
- Desk models
- Laboratory models



Overview • Delivery range



SYSTEC ENTWICKLUNG & FERTIGUNG

Reflow systems • Controller

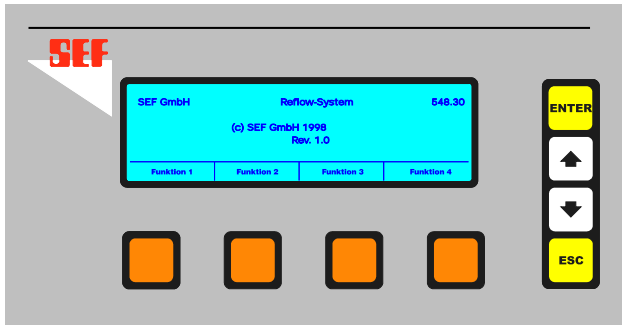

All **SEF Reflow systems**, except the **RP 6**, work with the same controller principle. Main part is the 8-Bit μ P 80C51 with battery backed real time clock. This CPU covers all transducers, setting outputs as well as interfaces for documentation.

A user-friendly operation is ensured by only four function keys, whose respective status is displayed on the graphical LCD.

The power electronics are completely placed on a module accessible from the front side in the free standing models, and on an extractable drawer in the desk models. A separate filter ensures that the application complies with CE standard. The maximum air-temperature is limited to 270°C by software. There is an additional excess temperature protection by hardware to preserve the system from damages in case the chamber sensor is failing. Thus the working range is suitable for leadfree solder pastes.

The software allows the storage of up to 16 different programs and 8 temperature profiles. It covers not only the function programming and regulation mathematics, but also the interface drivers and an integrated profile determination whose data is graphically displayed.

Language selection: German, English, French, Polish
further languages on request

PC-Software: **SOSY**

Most SEF reflow systems can be operated with our PC software **Sosy** alternatively. Therefore our ovens are equipped with an USB interface. In addition to the graphical display of the operating panel functions, the **Sosy** software also offers the possibility to print the program parameters, profiles measured by the integrated temperature profiler (only desk models) as well as a protocol (comparison of set values and actual values) via your normal Windows printer.

Of course it is possible to store more than 16 programs and 8 temperature profiles on your PC if necessary. Following you will see some screen shots of the **Sosy** software as an example for the oven **548.07**.

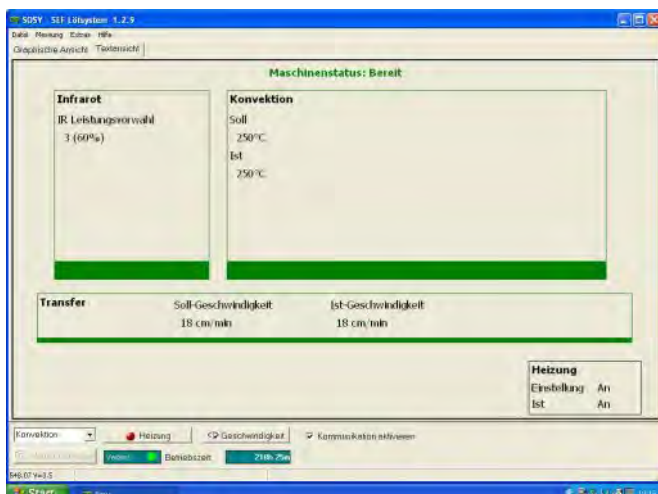

Textual view to change parameters

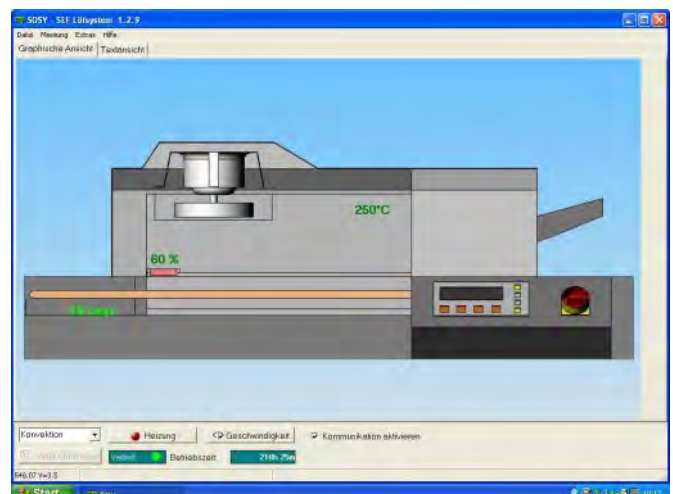

Graphical view to control the actual values

Our well-known desk-models have proved themselves in the manufacturing due to their compact construction and reliable soldering results. With capacities between 0,35 m²/h and 2,1m²/h (use-tracing relation 1:1) and with working widths between 18 cm and 35 cm their are capable for all branches of production, beginning with laboratory use up to bigger series production.

Easy and clear operation grants a use without problems. For easy removal of the PCBs a chute is included in the delivery. The transport occurs via a grid belt conveyor.

With the help of the integrated temperature profiler you can check at the display graphically if you produce within the required process window.

The transport occurs via a grid belt conveyor. Optional the **548.10** is available with a pin chain conveyor and so it is capable of inline production.

Unsere Lötssysteme bieten eine maximale Lufttemperatur von 270 °C im Peakbereich und sind damit auch für den Einsatz von bleifreien Lotpasten geeignet. Im Auslauf werden die Platinen durch Lüfter schonend abgekühlt.

Our soldering systems offer a maximum air temperature of 270 °C in the peak zone and so they are suitable for the use of lead free solder paste. At the outlet the PCBs will be cooled down via ventilators.

Our soldering systems are equipped with two standard soldering programs for solder pastes with and without lead as well as with a curing program which could be used as basic for creating your own programs.

Heating chamber principle:

Our desk models are all equipped with our well-proven sliding zone forced convection architecture. This heating chamber principle allows a quick and easy adjustment of your soldering profiles according to your special requirements by the change of only 3 parameters.

Inlet (1)

At the inlet the air is sucked in via a nonvertical air-shaft by a blower which is adjustable between 50% and 100%.

Peak nozzle (2)

Following the air is led through a radiator to the "peak nozzle".

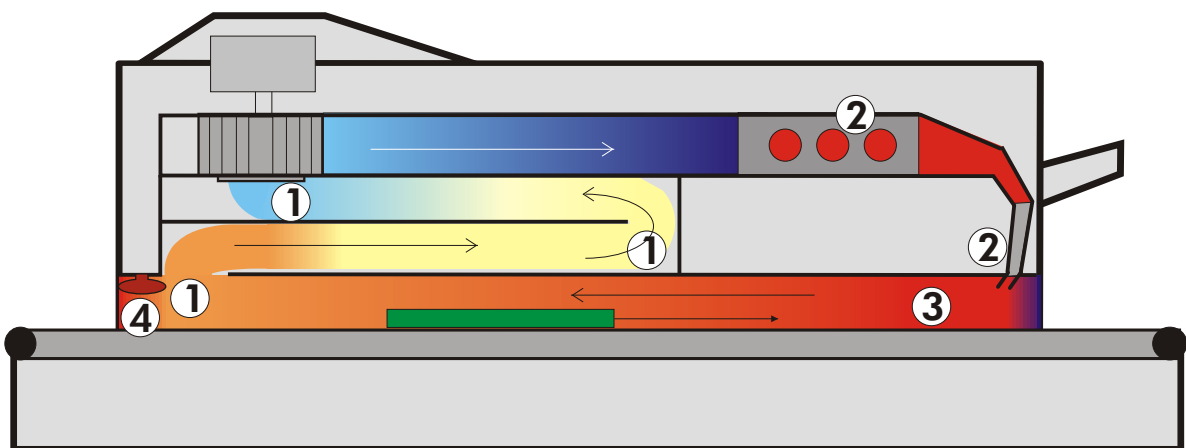

Inlet heating (4)

To support the pre-heat, an additional inlet-heater can be activated. For big heat requirements a peak support via IR-heater can be switched on at the **548.10**.

Pre-Heat-Phase (3)

After forming the "soldering peak", the air cools down fast under the melting point. It streams contrary to the transport direction and forms the "pre-heat" phase.

Reflow systems • Desk models

548.04 G



Typical lead free profile 548.04G



Technical data 548.04G

Length +210 mm for outlet chute	approx. 1000 mm
Width	approx. 600 mm
Height	approx. 500 mm
Weight	65 kg
Working width	180 mm
Active chamber length	600 mm
Conveyor speed typical	10 – 60 cm/min approx. 14 cm/min
Inlet height	40 mm
Connection value	3 x 16 A CEECON 230 / 400 V
Max. heating power	max. 6,8 kW
Exhaust volume	180 m ³ /h
Interfaces	1 x USB 1.1 (only slave operation)

548.07 G



Typical lead free profile 548.07G



Technical data 548.07G

Length +210 mm for outlet chute	approx. 1400 mm
Width	approx. 660 mm
Height	approx. 530 mm
Weight	90 kg
Working width	250 mm
Active chamber length	680 mm
Conveyor speed typical	10 – 60 cm/min approx. 20 cm/min
Inlet height	40 mm
Connection value	3 x 16 A CEECON 230 / 400 V
Max. heating power	max. 6,8 kW
Exhaust volume	180 m ³ /h
Interfaces	1 x USB 1.1 (only slave operation)

548.10 G/K



Typical lead free profile 548.10G



Technical data 548.10 G/K

Length +210 mm for outlet chute	approx. 2000 mm
Width	approx. 862 mm
Height	approx. 620 mm
Weight	250 kg
Working width	350 mm
Active chamber length	1300 mm
Conveyor speed typical	10 – 60 cm/min approx. 30 cm/min
Inlet height	40 mm
Connection value	3 x 16 A CEECON 230 / 400 V
Max. heating power	max. 11,4 kW
Exhaust volume	180 m ³ /h
Interfaces	1 x USB 1.1 (only slave operation)

Additional options: **Transfer elongation TFV 200 / TFV 300**



The transfer elongations allow an extension of the grid belt conveyor for approx. 20 cm and 30 cm respectively. Therewith a longer distance is available for the cooling of the PCB after the soldering process which is sometimes necessary when using lead free temperatures. The transfer speed is based on the adjusted speed of the soldering system because the TFV 200 will be connected parallel to the soldering system motor.

TFV 200	
Capable of soldering system	548.04 G / 548.07 G
Dimensions	206 x 376 x 160 mm lxxwxh
Working width	250 mm
min. PCB length	70 mm
Conveyor speed	as adjusted at the soldering system
Power supply	24 V, via soldering system
Colour	green or grey

TFV 300	
Capable of soldering system	548.10 G
Dimensions	304 x 478 x 210 mm lxxwxh
Working width	350 mm
min. PCB size	70 mm
Conveyor speed	as adjusted at the soldering system
Power supply	24 V, via soldering system
Colour	green or grey

Reflow systems • Free standing models

Series manufacturing: **7 ZCR**

With a capacity of 2,7m²/h and a use-tracing relation of 1:1, the manufacturing of medium up to bigger series is the optimal application for the **7 ZCR**.

The heating chamber of the **7 ZCR** has 4 heating zones, 2 cooling zones (1x passive, 1x active) and additional bottom heat over the complete heating zones. The heating zones are separated like the following:

Zone 1: Start up with IR heaters, max 450°C

Zone 2: Preheating 1 with convection heat, max. 290°C

Zone 3: Preheating 2 with convection heat, max. 290°C

Zone 4: Peak zone with convection heat, max. 290°C

Over the complete length of the 4 zones a heating plate for bottom heat is available, max. 250°C. Thus the **7 ZCR** has enough heating capacity for lead free soldering, also for thicker multilayer boards.

All temperatures of the mentioned heating zones are adjustable separately. In the convection zones the power of the blowers is adjustable, too. After the heating zones 2 cooling zones are following, one inside the chamber and one outside which cools down the PCBs gently to ambient temperature via blowers.

The operation of the **7 ZCR** can be done via the mounted operation panel or via an external PC optionally. Therefore an USB interface and our optional software **Sosy** are available.

The work with the operation panel occurs via a simple user guide with four function keys, whose respective status is displayed on the graphicable LCD.

Max. 16 sets of parameters can be stored as a separate program.

For a more comfortable, 3-channel measuring of temperatures our temperature profilers **570.70** and **570.77** are available additionally.

For the communication with upstream machines a potential free ready contact is included.



7 ZCR

7 ZCR

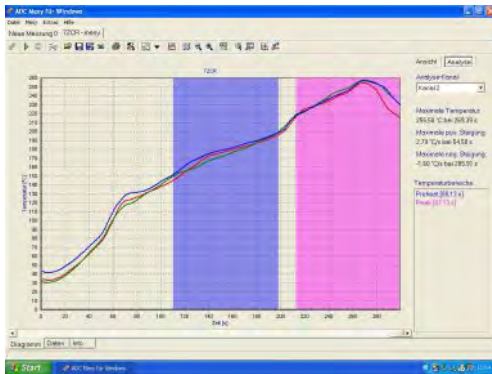

Typical lead free profile 7 ZCR



PC Software Sosy (optional), textual view

Technical data 7 ZCR

Length	approx. 2680 mm
Width	approx. 860 mm
Height	approx. 1350 mm
Weight	400 kg
Working width grid belt	350 mm
Working width pin chain	35 – 345 mm
Active chamber length	1500 mm
Conveyor speed typical	5 - 50 cm/min approx. 30 cm/min
Inlet height	40 mm
Connection value	3x32 A CEECON 230 / 400 V
Max. heating power	max. 21 kW
Exhaust air volume	180 m ³ /h
Interfaces	1x USB 1.1 (only slave operation)

Duplex conveyor

The system is equipped with a duplex conveyor. The duplex conveyor combines the advantages of the pin chain conveyor and the grid belt conveyor in one machine.

The pin chain conveyor supports the automatic in-line production.

The grid belt can be used for small separated PCBs and acts also as a middle support for wide boards while using the pin chain conveyor.

The adjustment of the working width follows by a handwheel.

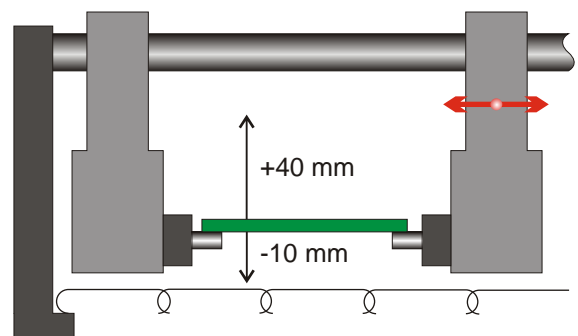

Reflow systems • Free standing models

Special machine for very big heat requirements: **549.30 B**

The **549.30 B** is a special soldering system for series manufacturing with very high energy requirements like aluminium PCBs. The system works with a combination of upper- and bottom heat to supply the necessary heat. For the upper heat we use two of our well-proven sliding zone heating chambers which are arranged inversely.

For the bottom heat four heating plates are used. The temperatures of the heating chambers as well as the temperatures of the heating plates can be adjusted separately. The conveyor is designed as a teflon bags conveyor to receive an optimal heat transfer from the heating plates to the PCBs. The assembly will be heated up gently by this way.

You can choose between 12 (standard) and nine teflon bags.. The PCBs will be cooled down to normal temperature in a cooling zone at the outlet of the oven.

With a capacity of 2,6 m²/h and a pause tracing relationship of 1:1, the **549.30 B** is suitable for big series.

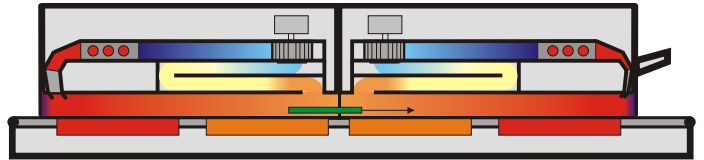

549.30 B



Typical lead free profile 549.30B



Technical data 549.30 B

Length	approx. 2700 mm
Width	approx. 980 mm
Height	approx. 1250 mm
Weight	350 kg
Working width	350 mm
Bag length with 9 bags	600 mm
Bag length with 12 bags	450 mm
Active chamber length	1250 mm
Conveyor speed	5 – 50 cm/min
typical	approx. 35 cm/min
Inlet height	40 mm
Connection value	3 x 16 A CEECON 230 / 400 V
Max. heating power	max. 16,8 kW
Exhaust air volume	180 m ³ /h
Interfaces	1 x USB 1.1 (only slave operation)

Small series, prototypes or component qualification: **Batch oven RP 6**

Our batch oven **RP 6** is the newest model in the SEF reflow family. With its compact dimensions, a max. PCB size of 300x200 mm and its low power consumption it is capable of prototype production, small series production as well as component tests.

The heating chamber works with a mix of radiant heat by IR heaters and convection heat by radiators. Therewith max. reflow temperatures of 280°C-300°C on the PCB are possible. An inspection window in the hood allows to observe the soldering process.

The **RP 6** has an integrated temperature profiler with 3 channels. The sockets for the connection are accessible at the front side of the oven. With the help of the provided thermocouple sensors the actual temperature profiles on the PCB can be measured and faded in the production window additionally. This allows an optimal comparison between set profiles and real profiles on the PCB. The optionally available Software "**Mesy for Windows**" allows the import of the actual profiles and a detailed analysis. With this software it is possible to detect values like max. positive and negative temperature increase, max. peak temperature, time above liquidus and so on.

After finishing the soldering process the drawer of the oven will open and two fans, integrated in the drawer and continuously adjustable, will cool down the PCBs to ambient temperature again.

The operation of the oven takes place by a PC or a notebook (not included in the delivery) which will be connected with the oven by a USB interface. The provided PC software offers at a glance all relevant information like oven status, explorer window for the selection of created profiles and a graphical display of the set temperature profiles.

The creation of the profiles takes place via a user-defined number of data points. For each data point you can adjust the temperature and the time so that a large number of profile variations are possible. Since it is possible to adjust the set profiles for the two IR heater fields (top middle and outer) and the two radiators (sidewise left and right) separately, an adjustment of the square profile to different PCB assemblies is also possible.

The normal power supply of the **RP6** is 230 V. For applications with big heat requirements the oven can be operated with 400 V (3 phases, N, PE) optionally.

Optionally the oven can be provided with a connection for nitrogen supply and the according flowmeter. With a consumption of approx. 0,5 m³/h it is possible to reach residual oxygen values of less than 50 ppm.

RP 6



Reflow systems • Laboratory systems

RP 6

System data RP6

Dimensions (LxWxH)	750 x 650 x 440 mm
Depth (opened)	1000 mm
Weight	approx. 50 kg
Min. PCB size	10 x 10 mm
Max. PCB size	200 x 300 mm
Varnish	RAL 7001/7047
Max. Reflow temperature	280 °C – 300 °C
PCB cooling	2x ventilators continuously adjustable
Continuous sound pressure level	< 70 dB(A)

System requirements

CPU	Pentium IV or similar
RAM	512 MB
Operating system	Windows 2000, XP, Vista
Graphic board	Standard graphic board
Monitor	Min. 15", better 17" resolution min. 1024 x 768 dpi

Energy supply

Connection value	230 V /N/PE optional 400 V (3 phases/N/PE)
Pnominal	3,5 kW optional 8,5 kW
Energy consumption in steady-state (at 100 °C)	0,5 kWh

Media supply exhaust air

Exhaust hose connection	60 mm
Necessary exhaust air volume	40 m3/h (ventilator is already integrated)

Media supply nitrogen (optional)

Connection fitting	6 mm hose connection
Working pressure (at connection fitting)	3 bar
N ₂ -consumption	approx. 0,5 m3/h
Operating state (500 ppm)	approx. 1-2 min.
Best value after	approx. 3 min. (approx. 50 ppm)

RP 6-Software: RESY

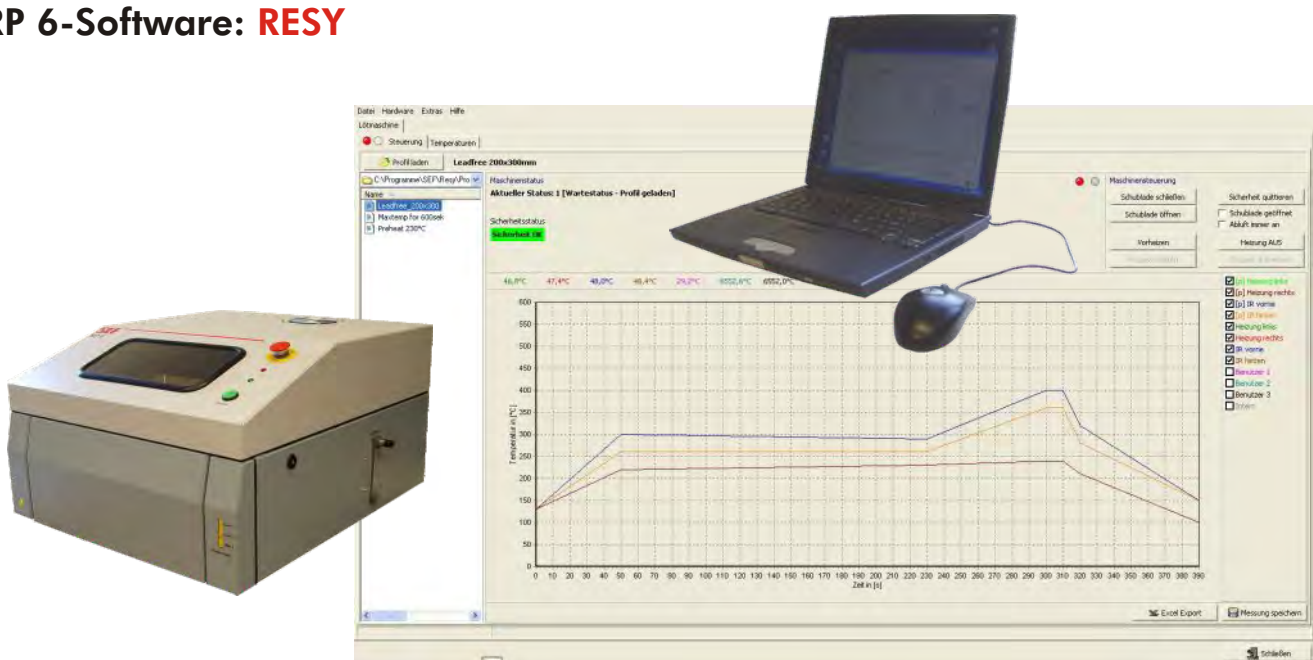

We offer additional equipment to support the production with our soldering systems for, example measuring and printing systems.

Measuring systems

Our USB-Mesy[®] **570.70** and **570.77 A** offer measuring in real-time mode and storage mode respectively. The software runs with Microsoft[®] Windows XP, Windows Vista and Windows 7. The reporting of the measuring occurs with the help of an extensive analysis module.

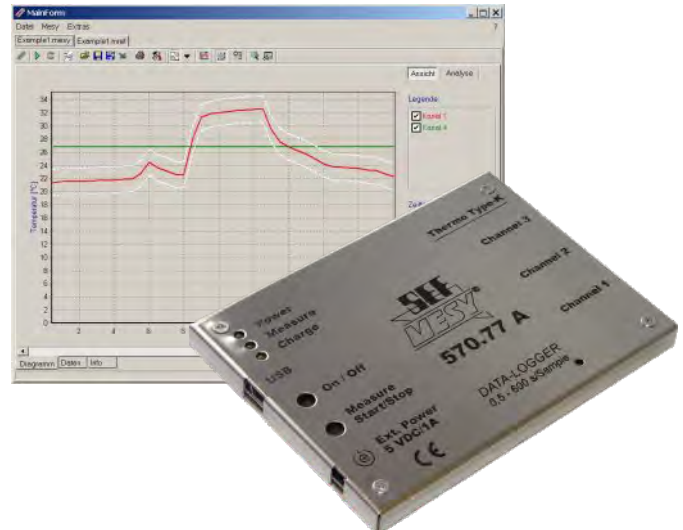
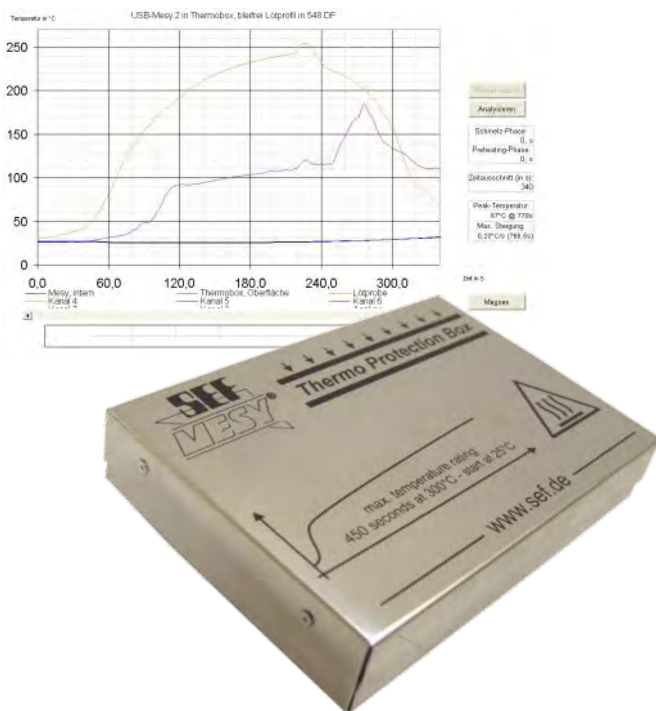

The parameter setting and the analysis takes place via PC. Together with the thermo insulating box **571.77** the Mesy **570.77 A** is suitable for the use inside reflow and wave soldering systems.

Printing system

With our printing system we have the right choice for the production of samples and small serie: The set Maxi - Printer **530.03** and the stencil clamping frame **530.13**. This set offers an easy and reliable use, high precision and repeat accuracy.



You will find more technical data about our **SMD accessories** in a special brochure.



SEF Systec GmbH
Kringelsburg 2a
21379 Scharnebeck
GERMANY

Tel.: +49 (0) 4136 909-0
Fax.: +49 (0) 4136 909-22
info@sef.de
www.sef.de

SEF
SYSTEC ENTWICKLUNG & FERTIGUNG