

# Laser Engraving and Cutting Machine User Manual for BCL-X Series



## **Jinan Bodor CNC Machine Co., Ltd**

Adress: Huaya Industrial Park, Kanghong Road, High-Tech Zone, Jinan,  
Shandong, China

ZIP: 250101

TEL: 0086-531-88690020

FAX: 0086-531-88690199

After-sales service: 0086-531-88270377

Website: [www.bodorcnc.com](http://www.bodorcnc.com)

Brief Introduction of Laser Engraving Cutting Machine.....	4
I Safety Knowledge.....	4
1.1 Basic Information.....	4
1.2 Optical Security.....	4
1.3 Electricity Security.....	4
II Equipment Brief Introduction.....	5
2.1 Instruction of Machine Model&Nameplate.....	5
1. Model Instruction.....	5
.....	5
.....	5
2. Nameplate Instruction.....	6
2.2 Equipment Composition.....	6
2.3 Power Strip.....	15
III Equipment Installation.....	16
3.1 Installation Preparation.....	16
3.2 Installation procedure.....	16
3.3 Grounding Connection.....	20
IV Test Equipment.....	20
4.1 Inspect before powering on.....	20
4.2 Adjust light path.....	21
V Rotation axis processing.....	28
VI Simple operation instruction.....	36
6.1 Software installation.....	36
6.2 Data line using operation.....	38
6.3 U disk operation.....	49
VII Equipment's maintenance.....	52
7.1 Daily maintenance.....	52
7.2 Water tank's change and clean.....	52
7.3 Exhaust fan's clean.....	52
7.4 Reflector's and lens' clean.....	52
7.5 Guide rail's clean.....	53
7.6 Light path's examination.....	53
VIII CO2 glass laser tube's precautions for use.....	53
IX Common Breakdown Maintenance.....	54
Appendix 1.....	56
《After-sale warranty of Laser Engraving Cutting Machine》.....	56
Appendix 2.....	59
Cutting and engraving parameters of laser tubes.....	59
Postscript.....	62
《After-sale warranty of Laser Engraving Cutting Machines》.....	62

## Preface

Thank you very much for your trust and purchasing our Products. We can provide perfect after-sale service and solutions. Please keep this manual and other attachments carefully, in order to guarantee the equipments safe running.

This manual is only applied to our company's standard machines. With regard to special customized machines, please read other reference material carefully.

This manual is written to demonstrate the issues about working principle, installation, operation, failure removal, transport, storage, maintenance etc. Please read the manual carefully, if you use the equipment the first time.

For quick and efficient using this equipment, the user should have qualifications as below:

1. The user needs to know basic computer professional knowledge, and can operate related editing and drawing software, such as Coreldraw, Photoshop, Autocad and so on.
2. The user should have basic optical knowledge and related electromechanical device's maintenance knowledge.
3. Before starting the equipment, make sure this equipment's operation procedure is known well and operate accordingly.

Because of equipments continuous updates, there may be some difference between your equipments and equipments shown in the manual in some aspects. We apologize for the convenience.

If you have any good suggestions or doubts, please log in our website [www.bodorcnc.com](http://www.bodorcnc.com) to leave a message or call us directly.

After-sales' Service: 0086-531-88270377

# Brief Introduction of Laser Engraving Cutting Machine

## I Safety Knowledge

### 1.1 Basic Information

- Make sure that the operator is being trained before operating the machine.
- Operator must be aside the machine during machine working. Never leave the machine alone in case to cause unnecessary loss.

### 1.2 Optical Security

Our laser equipment adopts the forth laser tube.Length of laser beam is 10.6μm. During machine working, we recommend people related to wear authorized laser safety goggles. Do not stare at the laser beam or anything beam reflected.

### 1.3 Electricity Security

- Before connecting electricity, please check carefully the requirements on the equipment's name plate, such as power,working voltage and so on.
- Without our permission, please don't dismantle electrical apparatus elements on the equipment, especially do not touch laser power and laer tube during machine working. Because the equipment has fatal voltage when working, and danger can still exist after disconnecting electricity.

#### 1 Harm

Various potentially dangerous substance can be eliminated through ventilation system during plastic material cutting. If smog or smell is too heavy, gas mask is needed.

#### 2 Other Harm

Out of security consideration, equipment modification is forbidden without the permission from the Manufacturer.

## II Equipment Brief Introduction

### 2.1 Instruction of Machine Model&Nameplate

#### 1.Model Instruction

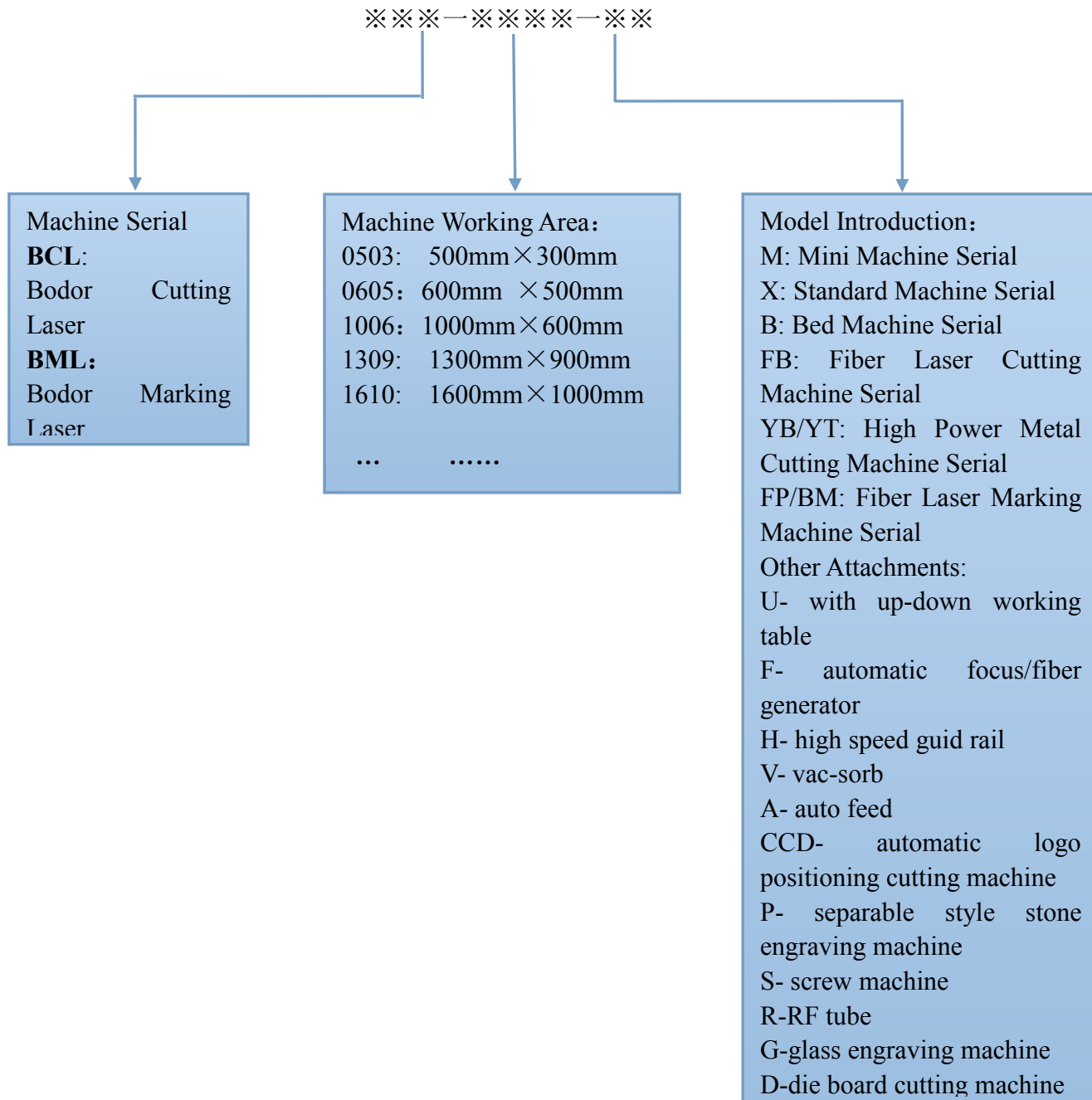

BCL1309X means standard serial laser cutting machines with 1300mm x 900mm working area and up-down working table.

## 2.Nameplate Instruction

This serial equipment is vertically installed in the middle of the transmission shaft, which can make speedy and stable cutting and engraving. The nameplate of machine is in the right-back side. You can read the relevant information on it. It is not accepted for anybody to change or remove this nameplate.

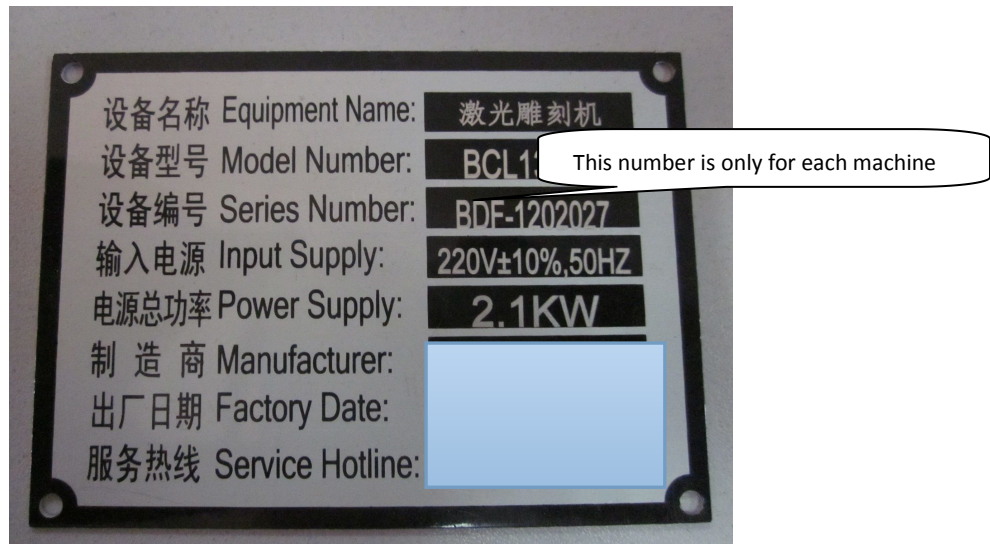

## 2.2 Equipment Composition

**Declaration:** Due to different models or new updates in products, there may be some difference in appearance or some partial detail. Specific equipment is subject to final product.

### 2.2.1 Composition of full set machine

A.Machine Shell B.Drive System C.Optical System D.Control System E.Spare Parts F. Tool Box

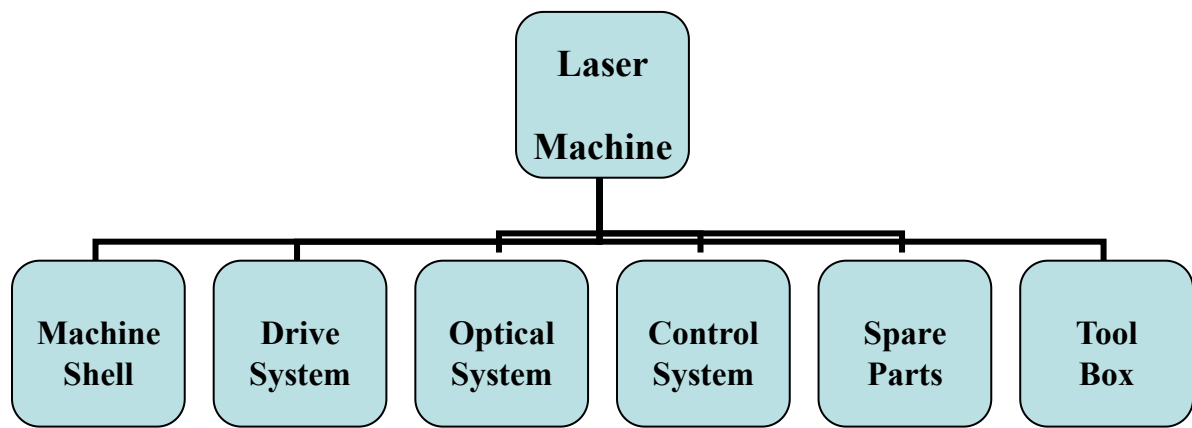

### 2.2.2 Machine Shell

**Right/Left Shield; Side Door; Up Cover; Transom(X Axis); Carling (Y Axis); Working Table.**

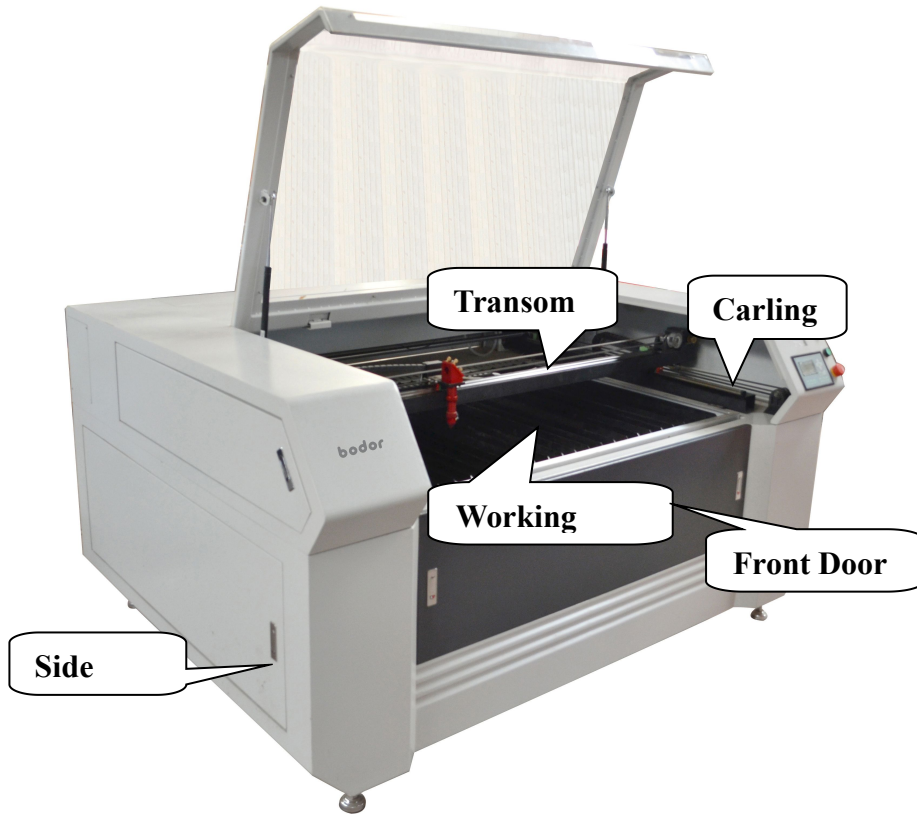

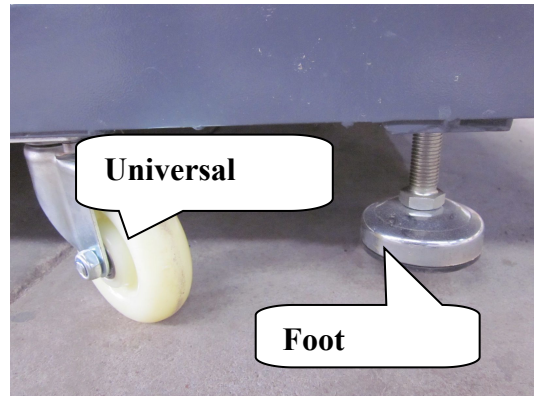
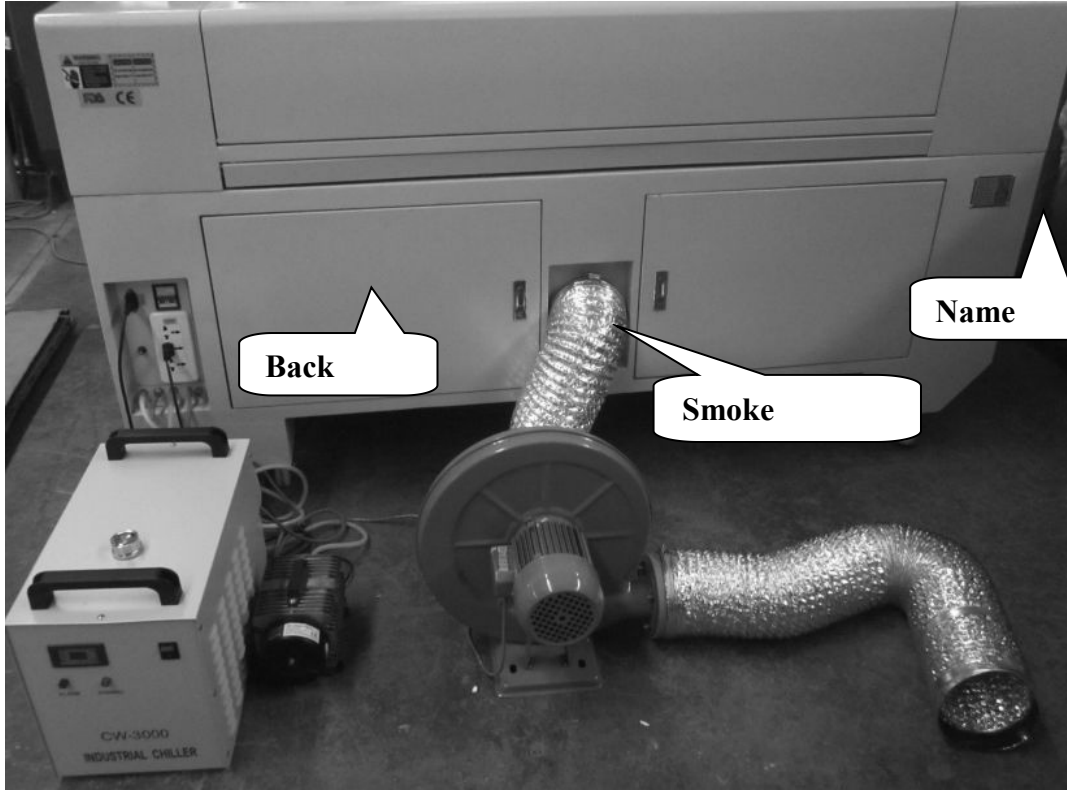

**USB Flash Interface**

**Computer Interface**

**2.2.3 Drive System:**

Y Axis:



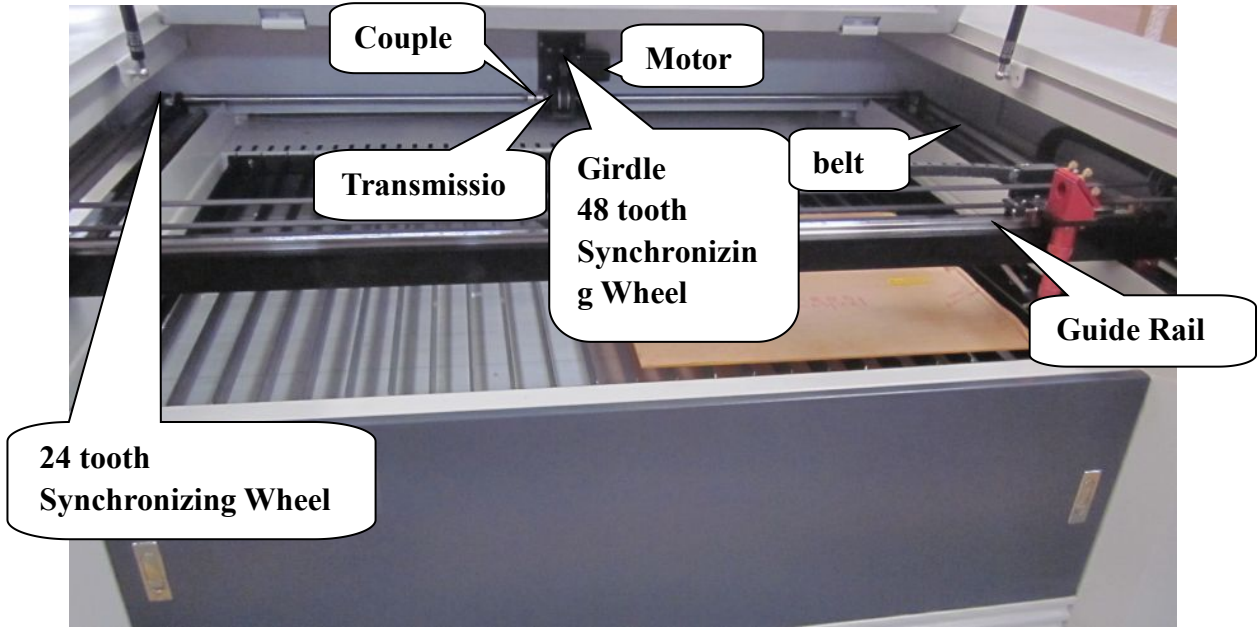

X Axis:

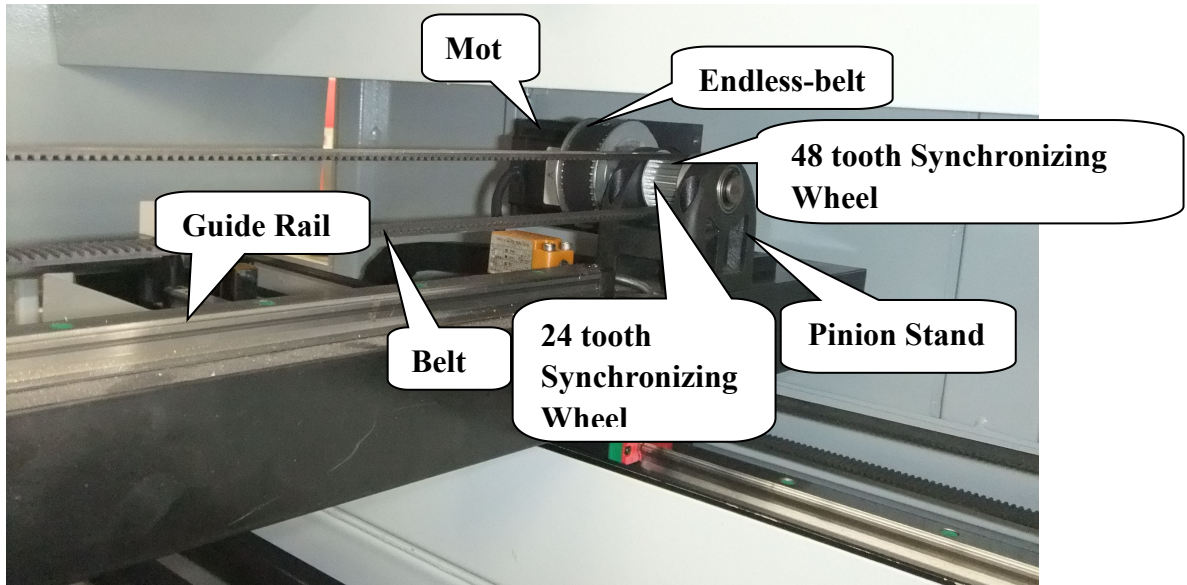

2.2.4 Optical System

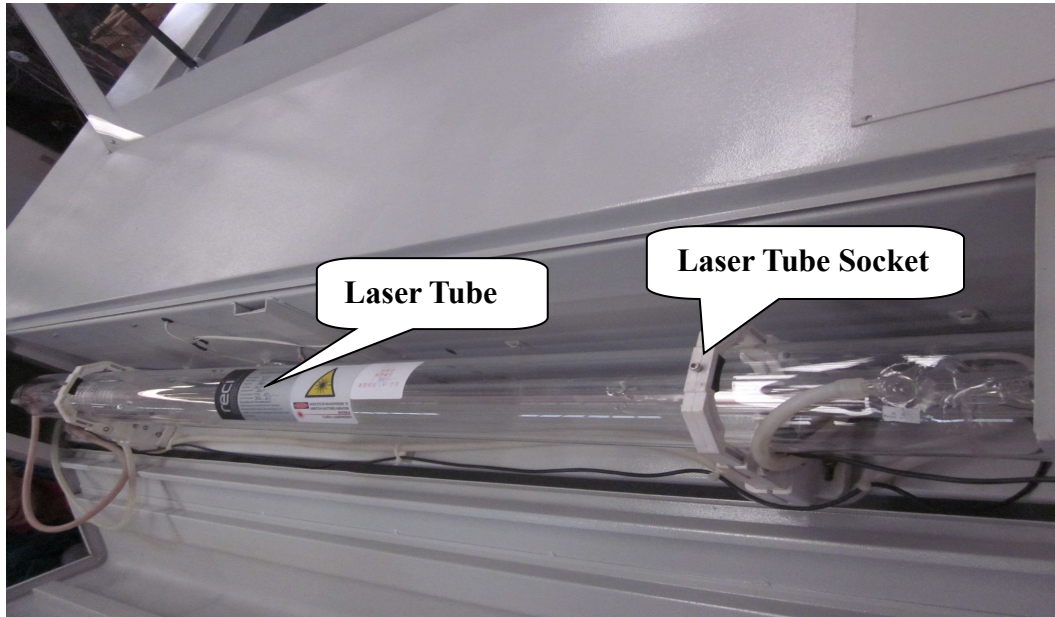

**Attention:**

The laser tube is fragile. It should be taken slightly. Water inlet of the laser tube should be in the lower place, and water outlet be in the higher place (reci laser tube), so there won't be any bubble. The laser tube socket should be installed with even force which can just make the tube secure. Do not overexert, it may crush the laser tube.

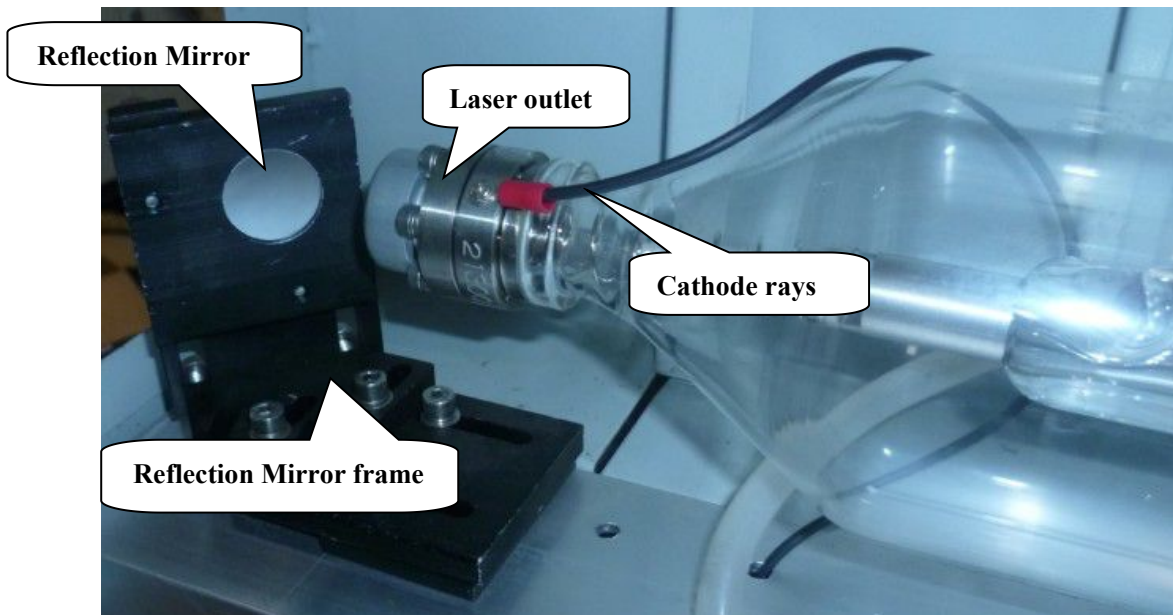

**Attention:**

The front surface of reflection mirror should be faced to the laser outlet.

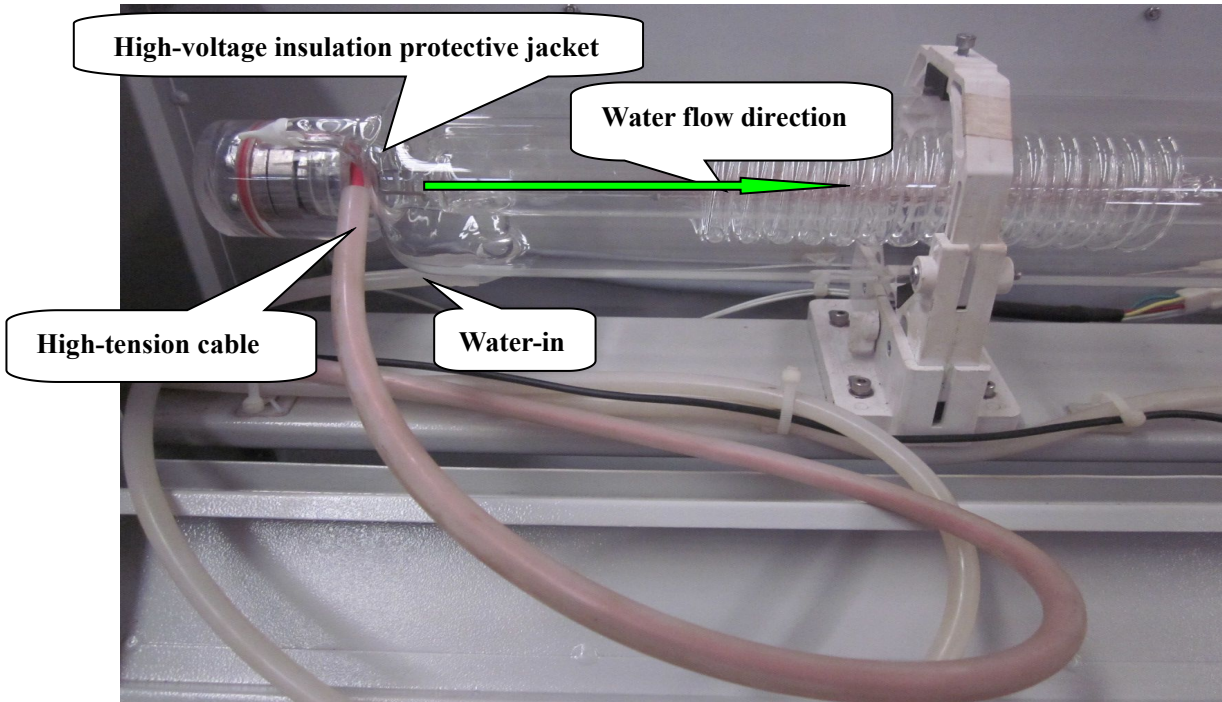

**Attention:**

The working-voltage of high-tension cable can be higher than 100,000V. There can be strong static electricity even when the power was cut-off in short time. Please do not touch the cable directly.

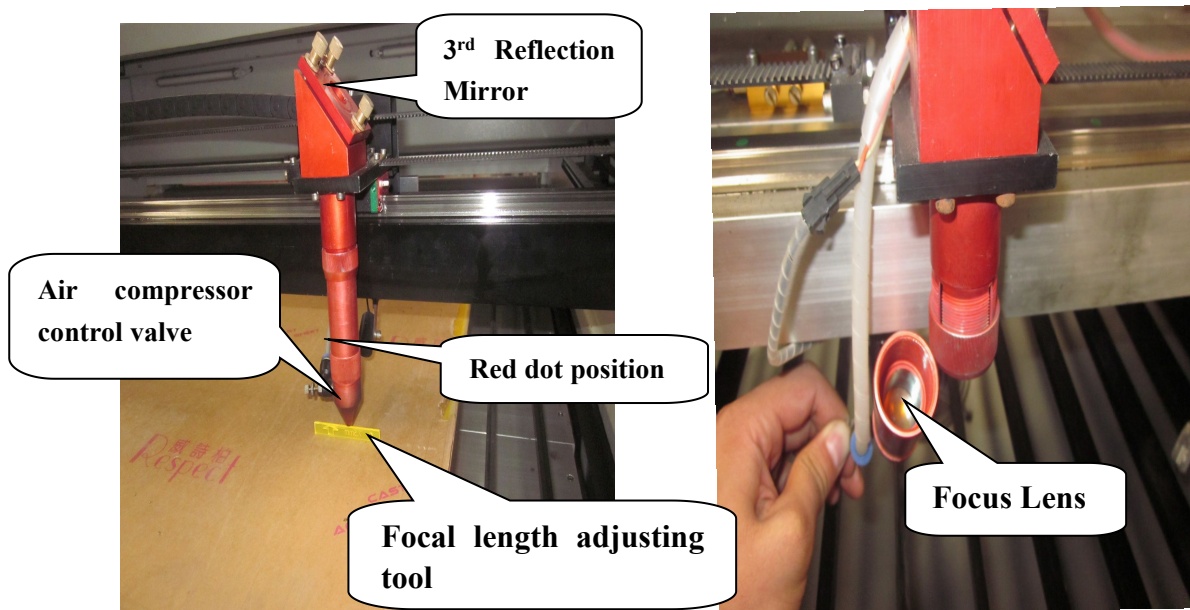

Installation picture of RECI laser tube

**Attention:**

Before working, please adjust the focal length. Put the focal length in the middle of working material and laser outlet before working. Convex surface should be faced to working material when installing focus lens.

### 2.2.5 Control System

There are some difference in the control system for different models. Specific product is subject to real object.

Bodor's control system is as below:

Leetro control system;

Ruida control system;

Bodor control system.



Leetro control panel



Ruida control panel



Leetro control board

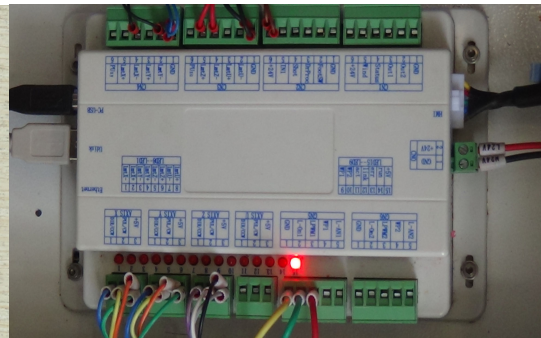

Ruida Control Board

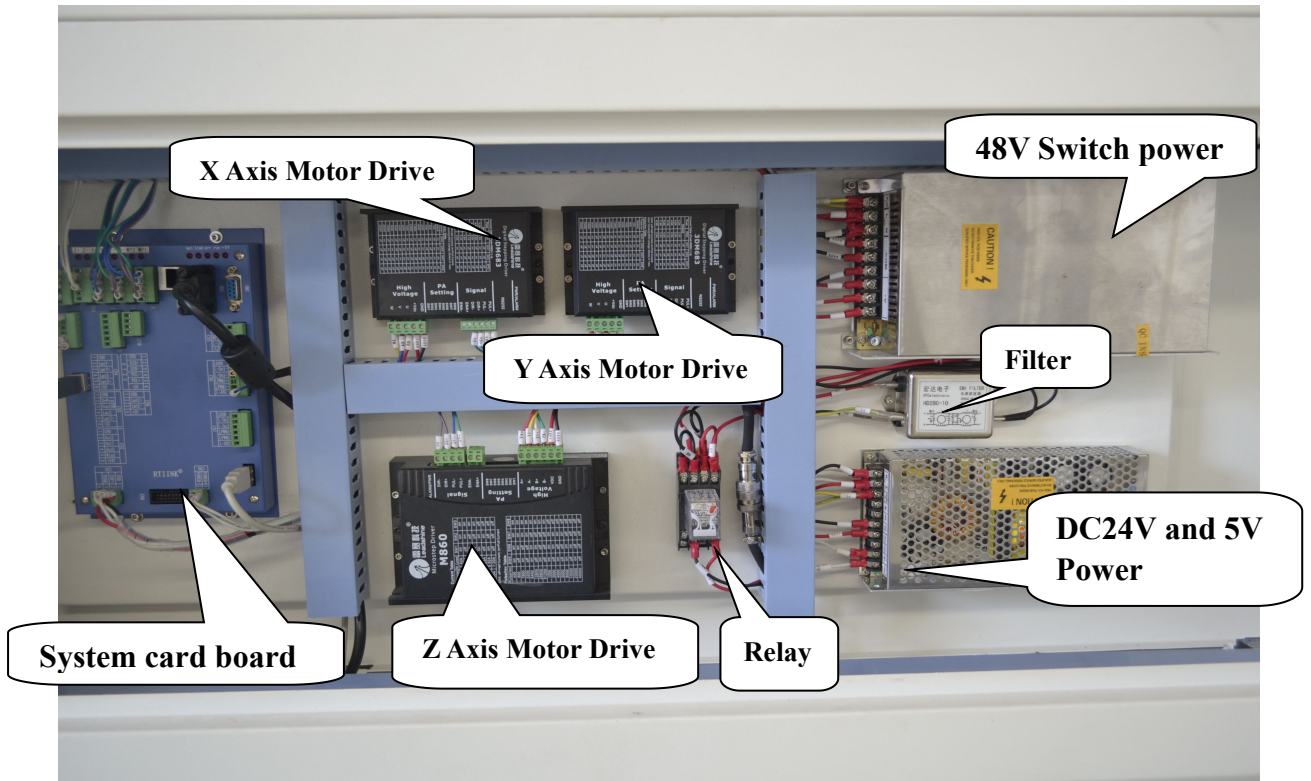

**2.2.6 Spare parts**



Water Chiller



Exhaust fan

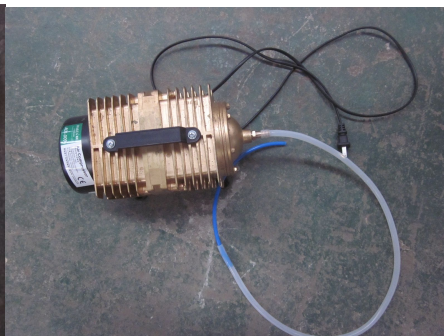

Air compressor

**2.2.7 Tool Box**



Attention: There can be some difference in toolbox for different models. Specific parts are subject to real objects.

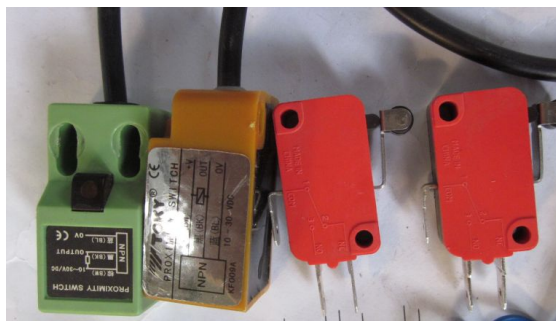

Proximity Switch&Inching Switch



Shovel Blade Usage



Focus Block Usage

### 2.3 Power Strip

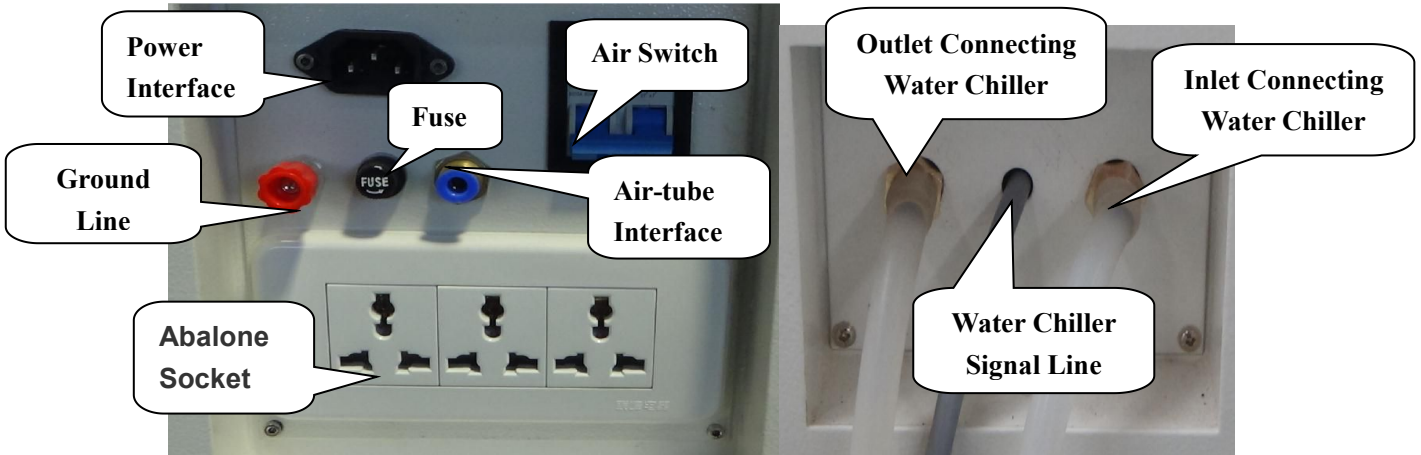

## **III Equipment Installation**

### **3.1 Installation Preparation**

#### **3.1.1 Preparation for workplace**

Make sure the working area is dry enough. And any electromagnetism, strong power, pollution is forbidden. Temperature of working environment should be 10°C to 38°C, humidity should be 10- 90%. AC 220V±10%, 50HZ, resistance to ground less than 5Ω.

#### **3.1.2 Preparation for operator**

We demand the operator must be professional technician. If the users want to install the equipment on their own, they need to have training from our technicians and completely master the knowledge of installation.

#### **3.1.3 Preparation for tools**

There is already a tool box with this machine. Besides, multimeter and screwdriver and other detection tools are needed.

#### **3.1.4 Other preparation**

The users need to prepare relevant material,including purified water or distilled water for water chiller, power strip, computer,pipe for discharge smoke, sample material, etc.

Attention: The users need to accompany all the time when our technicians install the equipment. The users need to grasp the skills of installation and commissioning which are the part of training.

### **3.2 Installation procedure**

#### **3.2.1 Package of laser tube**

##### **Laer tube package:**

In case of damage during transportation or outside force, the tube is packed with sponge. And two ends of tube are sealed with zip lock bag to prevent the mirror from pollution or scratch. Finally, the tube is built up with sponge supports to prevent tube have direct contact with surrounding.



**Laser tube devanning:**

Open the carton box, take out the laser tube. Both hands hold the middle of the tube; take off the sponge supports; take off the packing sponge; take off the zip lock bag. Then inspect whether the tube is intact.

Attention: It needs as least two persons when unboxing. Handle the tube with care.

**3.2.2 Installation of Laser tube**

Move the equipment to the back place, so as to install the laser tube easily.

The laser tube is installed in the back of crossbeam. Open the laser tube protective cover. You can see two laser supports, two water pipes, a black color low-tension line and a red color high-tension line.

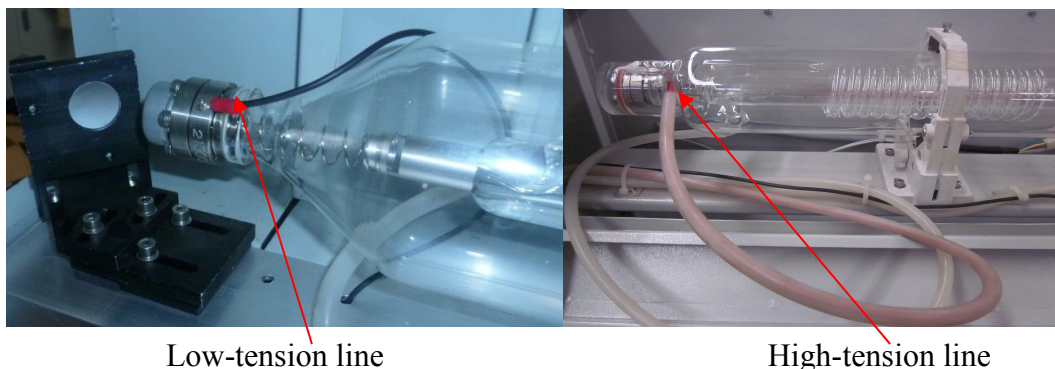

Low-tension line

High-tension line

**Laser tube installation:**

1. Take off the screw from the two laser support which are used for fitting the laser tube.
2. Put the outlet (low-tension part) of the laser tube on the base facing to the first reflected mirror.
3. Buckle the upper part of the laser tube support, tighten the screw, connect the high-tension & low-tension line and outlet & inlet water tube.
4. Fix the laser tube.

**Attention:**

- Keep the laser tube outlet clear in case of front mirror breakdown. The broken damage caused by improper operation, will not be in Bodor's range of protection.
- Fix the laser tube with proper strength. Larger strength will broke the laser tube.
- Keep the laser tube water inlet in the lower place, and the water outlet in the higher place (in the upper section of laser tube). Come in from the bottom, out from the top as shown in the above picture.
- Water tube joints must be connect well avoiding water leaking. Water tube must be straightened.
- Handle laser tube carefully when installing. High-tension wire and cathode rays should be fastened enough. Water inlet should be in the bottom and water outlet in the top. Make sure there is no air bubble in the laser tube. Use even force on the two sides when pushing laser tube sockets to fix the laser tube. Do not use too much force avoiding the damage of laser tube.

### 3.2.3 Installation of Water Chiller

▲ First take down the cover of water inlet on the top of the chiller. Pour purified water or distilled water into the water tank until it is full.

▲ Then complete the connection of water cycle pipelin by connecting the water outlet of the chiller with the water inlet of the machine, and the water inlet of it with the water outlet of the machine.

▲ Finally, connect the holding wire and the water chiller power line.

Pressing the rocker switch after electrifying the chiller, you can hear sound like "didi...".Then the water in the tube will flow from high-tension terminal to low-tension terminal. Then the green indicator light on water chiller will be on. The system works well if the alarm does not ring.

**Attention:**

- When working, the water must flow from the high-tension to the low-tension. Otherwise, it may damage the laser tube.
- When the power is on, the bubble in the tube can be removed by extruding the water pipe or turning the laser tube.
- When machine is working or shut down, please do not touch the high-tension line. It may still have high power and may threat to life.

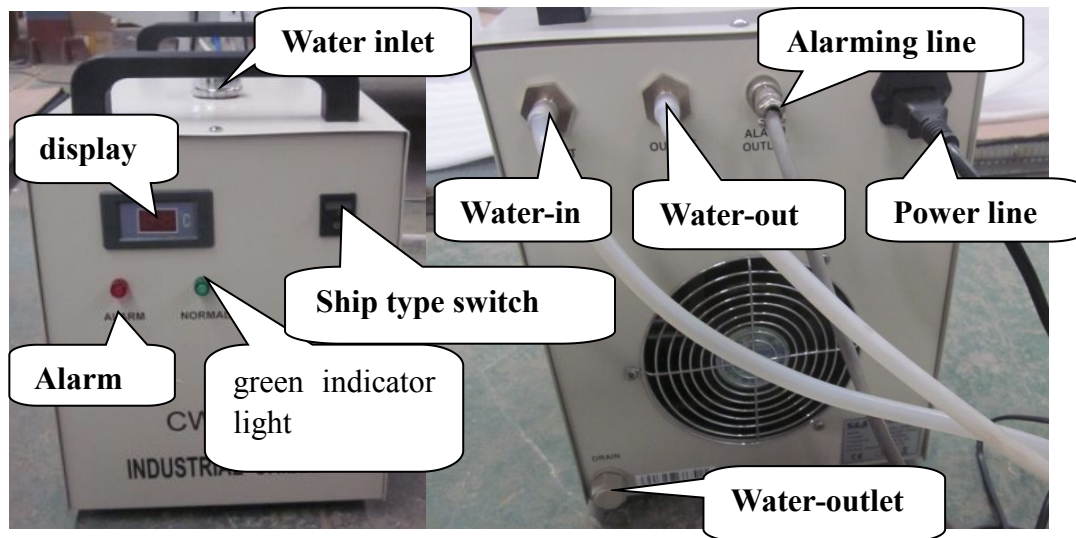

Chiller installation: water-inlet in the top side, water-outlet under the back below side

### 3.2.4 Installation of Exhaust Fan and Air Pump

#### Installation of Exhaust Fun

Connect the air inlet of the fan with exhaust port by the air duct and screw tightly with spanner. Then connect the outlet of the fan by the other air duct and lead it out of the room. The installation is as shown in the below.



### Installation of Air Pump

Insert the silicone tube into the air-inlet by an air tube. Then connect the power and make the smooth air-out of the air entry in the leaser head as shown in the below picture.

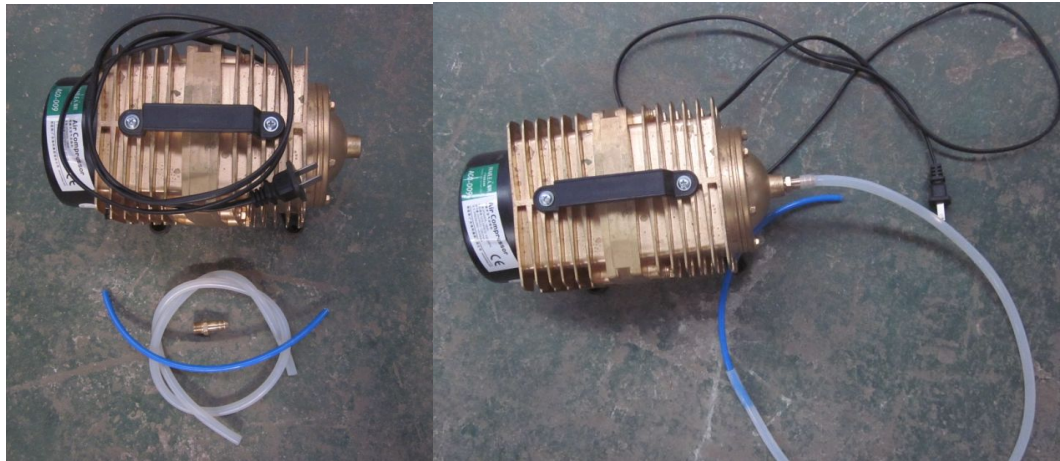

Air pump (air compressor) is very important in the system. High-pressure air sprays from the light outlet of laser head through air tube. On one hand, it can keep the focus lens clear enough. On the other hand, it can prevent working material from burning. Please make sure the rubber tube is intact during machine working. Otherwise it may cause burning of the materials.

### 3.2.5 Installation of accessory

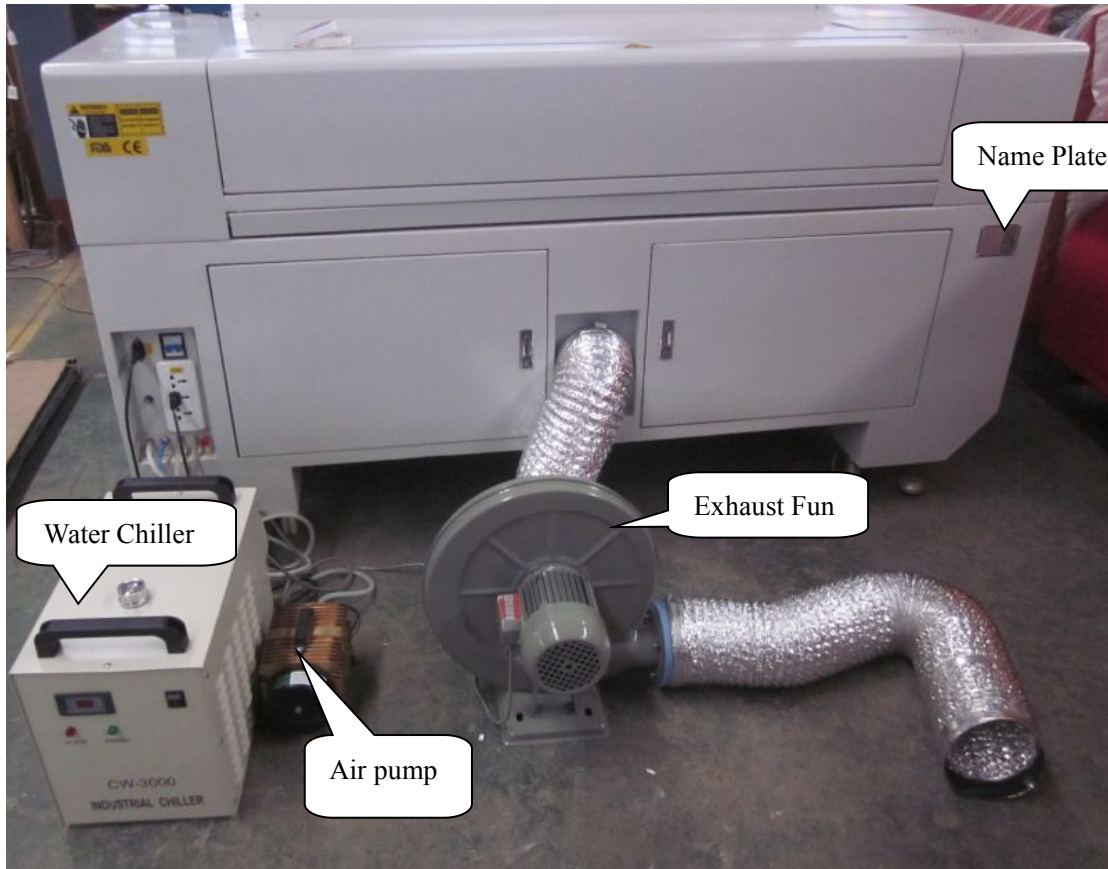

## 3.3 Grounding Connection

Grounding requirements for the equipment are very strict. Your local electric system must meet the local electric security standard.

L : 220V Live line; Phase line

N : Zero Line, compose the electric system together with phase line

E: Grounding line, connect every grounding part of electricity consuming accessories, resistance to ground should be less than 4 Ω

**Attention:**

Nonstandard grounding may lead to high failure rate and other security accidents. All these are not in the range of Bodor's protection.

## IV Test Equipment

### 4.1 Inspect before powering on

Before powering on, please inspect and make sure all electric wire terminals are intact.

Then pull the laser head to check whether it can move smoothly and move the crossbeam front and back to confirm whether it can be noise free. Power on when everything is ok.

#### **4.1.1 Boot Process**

##### **Open:**

Air-break switch "ON"---> Roll emergency switch ---> Press switching button---> Open rocker switch of water chiller---> Open the rocker switch of air pump, air exhaust and laser tube.

##### **Shut down:**

Shut down the rocker switch of air pump, air exhaust and laser tube--> Close the rocker switch of water chiller ---> Press emergency switch ---> Air break switch "OFF"

#### **4.1.2 Test Running**

Power on. Then press the direction key on control panel to test whether laser head can move normally, whether X axis beam have any noise, whether each device can work properly and whether the movement and process back to the origin is normal. If everything is ok. Then you can proceed the below step: Debugging of laser path.

## **4.2 Adjust light path**

#### **4.2.1 Test laser**

After the equipment is powered on, please make sure the water flow direction in laser tube is from high-tension terminal (red line) to low-tension terminal (black line); inlet and outlet water pipe and electric line connect properly. Most importantly, be sure there is no bubble in the tube.

Next, stick one acrylic block on the first reflection mirror, press the "Laser" button on control panel to test whether there is laser out of the tube or there is facula on the acrylic block. If there is no facula or weak light, then you need to check whether you have set the potentiometer on the max value, or whether the water chiller is connected in right way. If there is still no light, then there may be some defect of laser tube or laser power supply.

### 4.2.2 Adjust light path

The laser path is debugged OK before shipment. While there may be deviation of laser path during long time transportation. You need to debug the laser path if it happens.

Laser Fundamental Diagram as below:

Optical system consists of a laser tube, 3 reflection mirrors, 1 focus lens, a laser head and red dot position system.

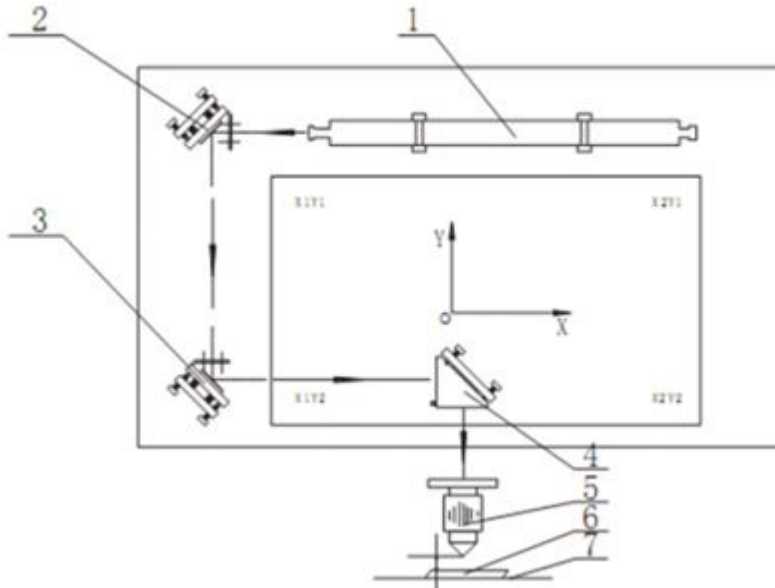

1. Laser tube 2. First Reflection Mirror 3. Second Reflection Mirror 4. Third Reflection Mirror 5. Focus Lens 6. Working Material 7. Work Table

Laser is reflected to first reflection mirror through front mirror of laser tube, then goes to second and third reflection mirror, and finally then reaches the working table through focus lens. Finally reach on the work table. In fact, laser path is the process of several reflections and focus. If screws loosen in the process, there can be laser path deviation. The laser will not emit from laser outlet.

#### 4.2.2.1 Necessities for adjusting laser path

Laser adjusting block, double faced adhesive tape, focal length block, shovel blade, needle-nose pliers

#### 4.2.2.2 Methods for adjusting laser path

##### In principle:

Adjust the reflected facula into a dot, then move the facula into the center by adjusting the position of laser tube.

Laser shoot from laser emitter goes through first, second and third reflection mirror successively and reaches to work table through focus lens. Its working principle is to get the best engraving and cutting effects after several reflections and focus. If laser path is not smooth, it may damage laser generator, reflection mirror, focus lens etc. Please re-adjust the laser path if it is not correct.

**Detailed procedures of adjusting laser path are as below:**

**1. Adjust first reflection mirror**

The best effect is that the facula from laser tube is in right of the center.

Adjusting method:

- Paste a 3mm acrylic on the first reflection mirror.
- Press pulse button.
- Check whether the facula shoot is on the first reflection mirror. If it is not on the first reflection mirror, please adjust the installation position of laser tube or mirror mount.

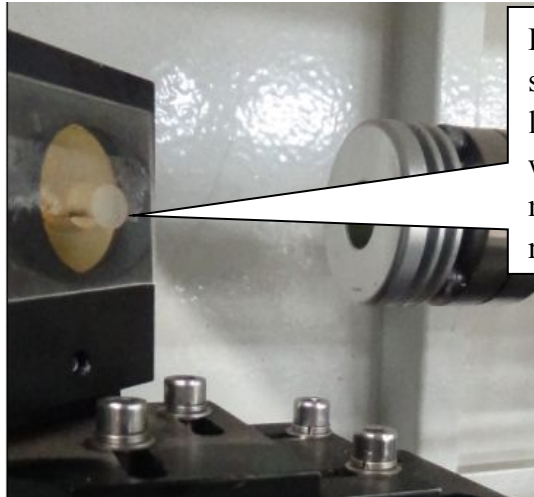

Before adjusting, make sure the light outlet of laser tube should be identical with the hole of laser head. Laser from laser tube should be in the back of the center in the mirror which can make the laser path reflection better. Adjusting method: adjust the installation position of laser tube or first reflection mirror mount.

**2. Adjust second reflection mirror**

The best effect is that the facula reflected by the first reflection mirror is in the right of the second reflection mirror center.

**Adjusting method:**

- Paste a 3mm acrylic on the second reflection mirror. The second reflection mirror is in the far left of the crossbeam.
- Press the direction button on control panel to make the crossbeam move to the nearest place near first reflection mirror.
- Then press pulse button and check the position of the shoot facula.
- Press the direction button on control panel to make the crossbeam move to the furthest place near first reflection mirror.
- Then press pulse button, do not move the crossbeam and check if the facula is identical with the facula from near place. If they are not identical, please adjust 3 screws behind the back of first reflection mirror, until they are identical. After they are identical, move the crossbeam front and back to check if they are still identical in the right of the mirror. If not, please fine-tune 11,12,13 screws of mirror base and turn the second reflection mirror mount.

Attention:

Optical system of bed is in the inside of gantry. The adjusting of second reflection mirror is easier. Just adjust the first reflection mirror.

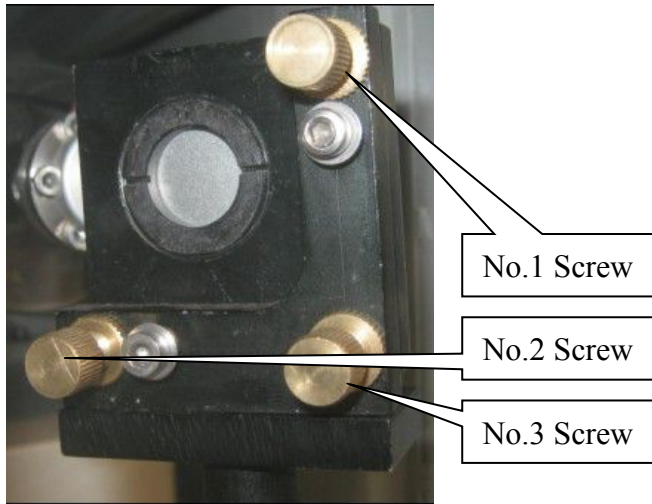

No.1 Screw

No.2 Screw

No.3 Screw



Testing method when laser is reflected from first reflection mirror to second reflection mirror:  
 Move the second reflection mirror on Y axis at the nearest and farthest position from first reflection mirror.  
 From the first reflector to second reflector, the laser beam should be fell on the same point from both nearest and farthest position to the first reflector.  
 Upper--please adjust No.1 screw;  
 Lower--please adjust No.2 and No.3 screw;  
 Left—please adjust No.2 screw;  
 Right—please adjust No.1 and No.3 screw.

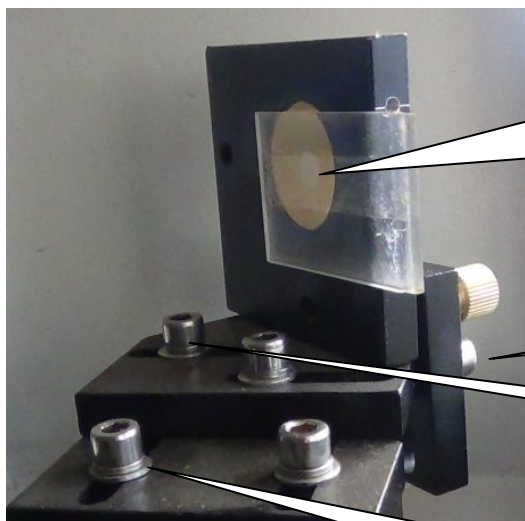

If light on the same point is not on the right side of the center, please adjust No.11,12,13 screw to relevant position ( generally don't need to require adjustment).

No.11 Screws ( two screws)

No.12 Screws ( two screws)

No.13 Screws ( two screws)



### 3.Adjust third reflection mirror

The best effect is that the facula reflected by the second reflection mirror is upper to the center of the third reflection mirror.

Method:

- Paste acrylic on the inlet of laser head. Move laser head to the leftest of the beam by left-right direction button on the panel. Press ‘pulse’ button and check the position of the facula.
- Move the laser head to the furthest right of the beam by direction button on the panel and press pulse button. Do not move the laser head and check if two faculas from the furthest point and nearest point are identical. If they are not identical, please adjust 3 screws(21,22,23) on the back of the second reflection mirror until they are identical.
- After they are identical, please move laser head left and right to check if they are still identical on the mirror center. If not on the mirror center, please adjust the height of laser tube or 3 screws(1,2,3) on first reflection until the faculas are on the mirror center.

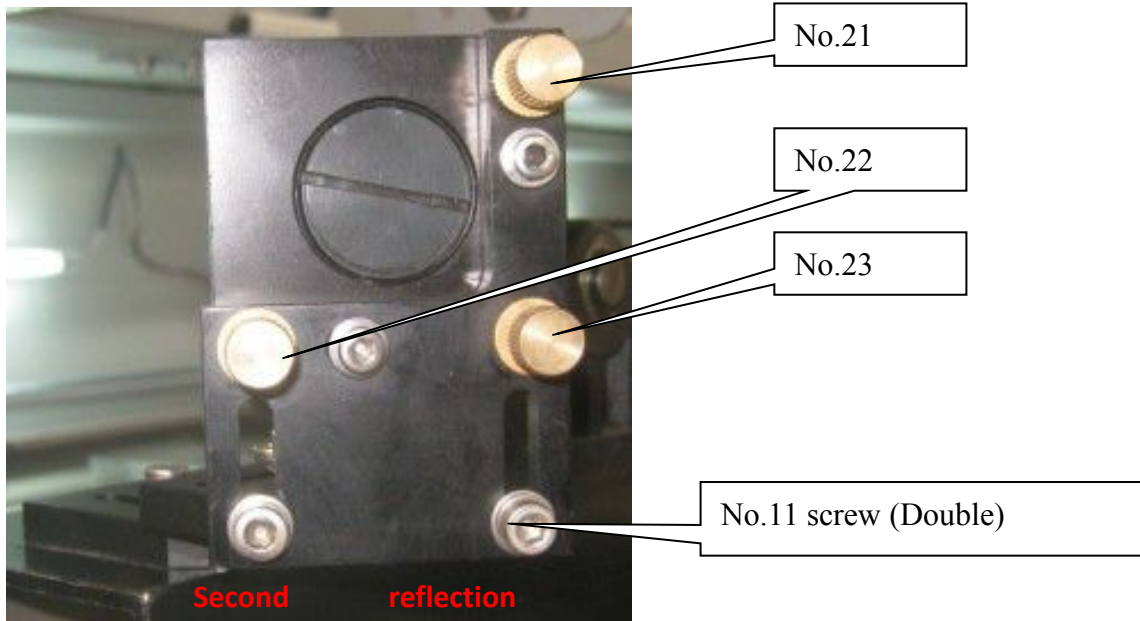

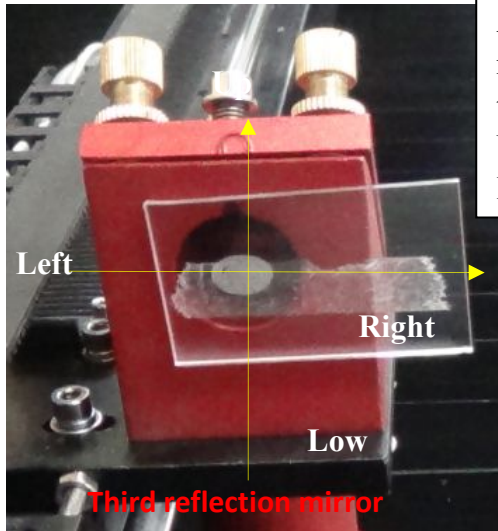

Accordingly, from second reflection mirror to third reflection mirror, laser should fall on the same upper side of the center slightly.  
 Upper—adjust No.21 screw; lower—adjust No.22,23 screw;  
 Left—adjust No.22 screw; Right—adjust No.21,23 screw.

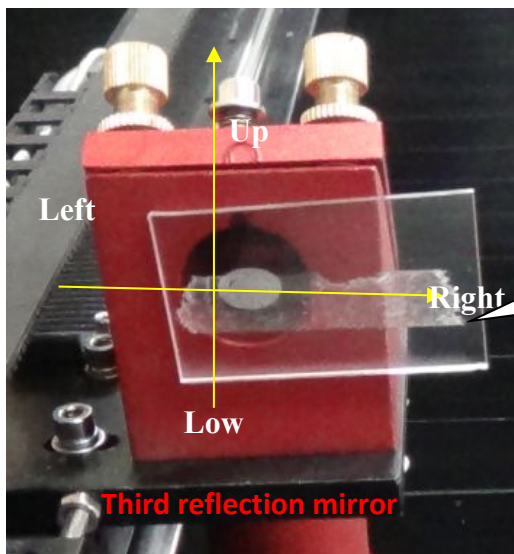

If light on the same point is not on upper side of the center slightly:  
 Left or Right -- adjust No.1,3 of first reflection mirror  
 Upper / lower -- adjust the position of laser tube.

**4.Adjust focus lens**

**The best effect is that the facula reflected by third reflection mirror is on the center of outlet.**

Method:

- Adjust the lens cone to focus. Paste double-sided adhesive on the laser tube outlet.
- Press pulse button and check if the facula is on the center as shown in picture A. If not, please adjust 3 screws on third reflection mirror.
- If there is no light on the outlet, please take off the cone head of lens cone. Then paste double-sided adhesive tape on the laser tube outlet. Press pulse button and check if the facula is on the center. If not, please adjust 3 screws of third reflection mirror until the facula is on the center. Then reinstall the ,
- Repeat these above procedures until the facula is on the center.

**Attention:**

You need to adjust the laser path after cleaning or changing mirrors.

Deviant optical path can affect cutting effects and quality, even damage focus lens.



No.31 screw

No.32 screw

No.33 screw

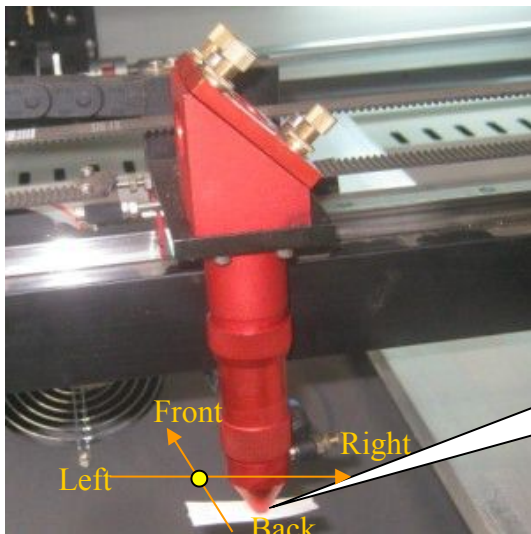

put a double-sided adhesive tape on the outlet of the laser head, take left hand side as left, right hand, right;laser tube side, front and people where

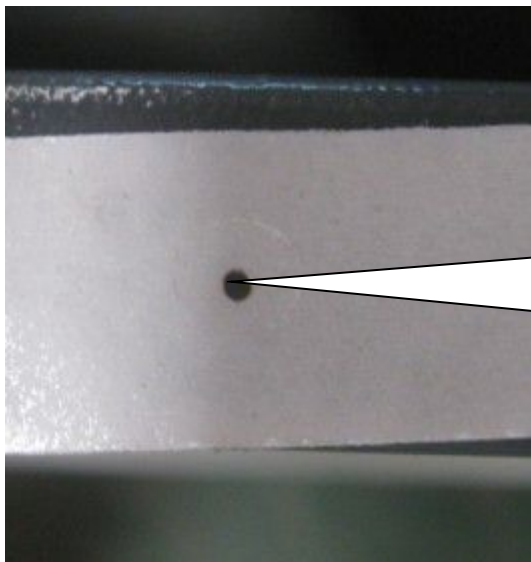

Laser beam spot should be in the center of the outlet. Please refer to picture A. If not, please adjust No.31,32,33 screws.  
 Left -- please adjust No.32 screw;  
 Right -- please adjust No.31 and 33 screw;  
 Front -- please adjust No.32 and 33 screw;

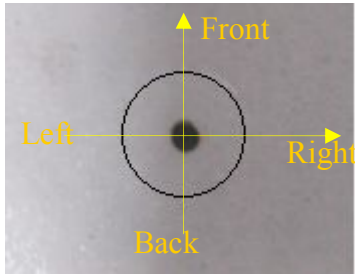

Picture A

**Focus test is as shown in picture A:**

First paste double-sided adhesive tape on outlet, press pulse button and check if the facula is on the center of outlet. If not, please adjust 3 screws of laser head.

**Attention:**

Laser is invisible light but can do harm to human body. Please keep away from the laser path when debugging. The operator must master the basic knowledge of laser machine.

**4.2.3 Trial Processing**

Put working material on the work table.

After laser path is adjusted, rotate screws of lens cone to the height of focusing clockwise. After adjusting focus, lock screws of lens cone anticlockwise. Then move the laser head to specified location. At last open software, make or transfer pictures, set working mode&speed&efficiency.

Then you can work the material after nominating downloaded files.

Take following picture as a reference.

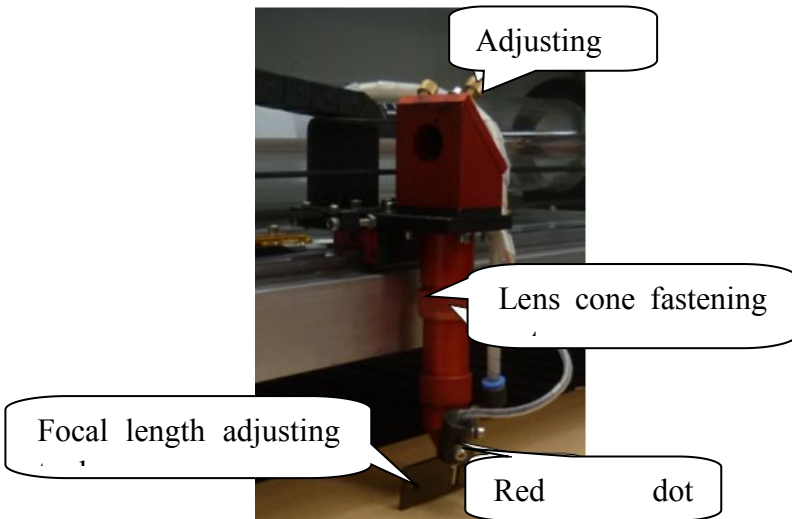

**V Rotation axis processing**

1. Electrical appliance installation

### 1.1 Rotation axis connect

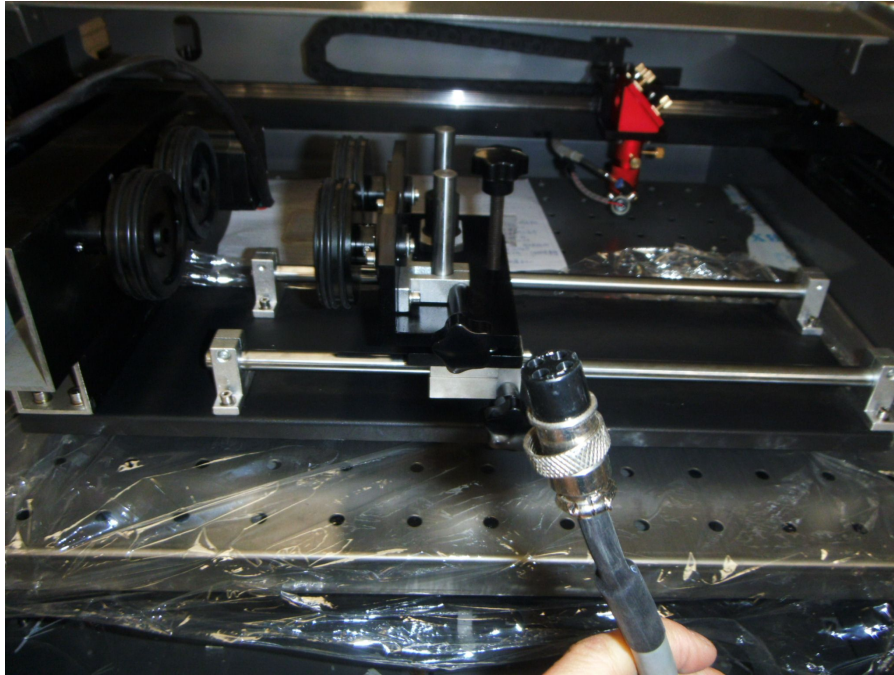

Fix rotation axis

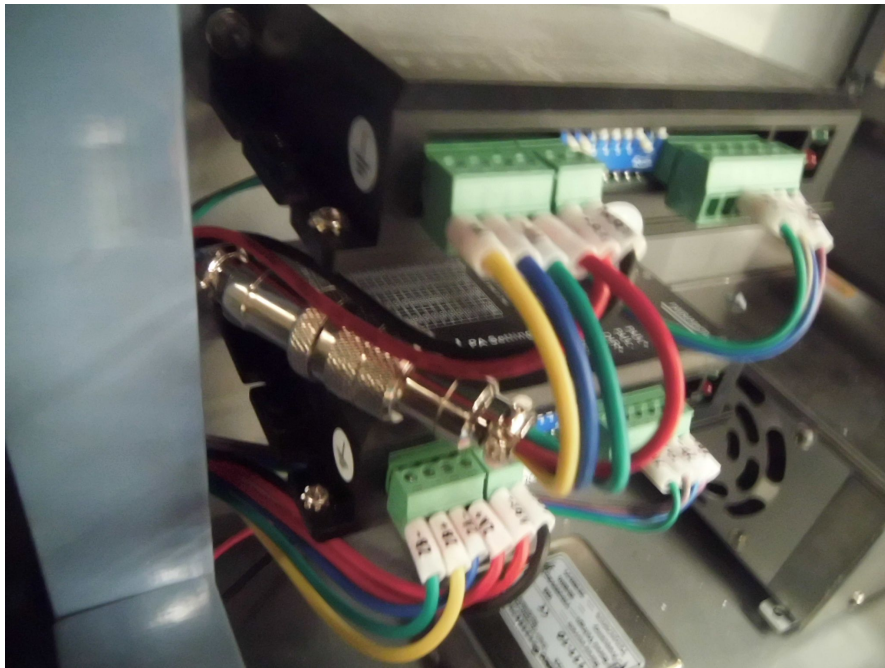

Draw out aviation connector of the drive.



Connect the aviation connector of rotation axis with the drive's aviation connector

### 1.2 Reset on power

Power on the machine, then touch the limit switch of Y axis by metal manually to assist equipment resetting work when resetting the machine as shown in the picture:

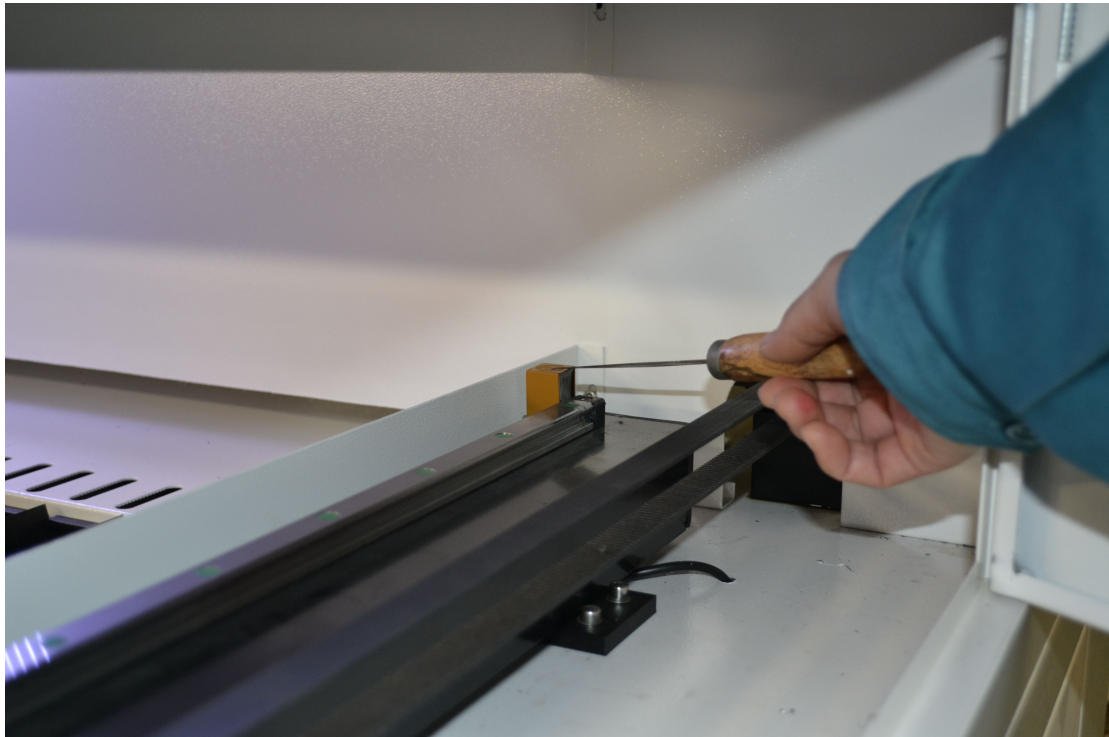

## 2. Software operation

### 2.1 Software set

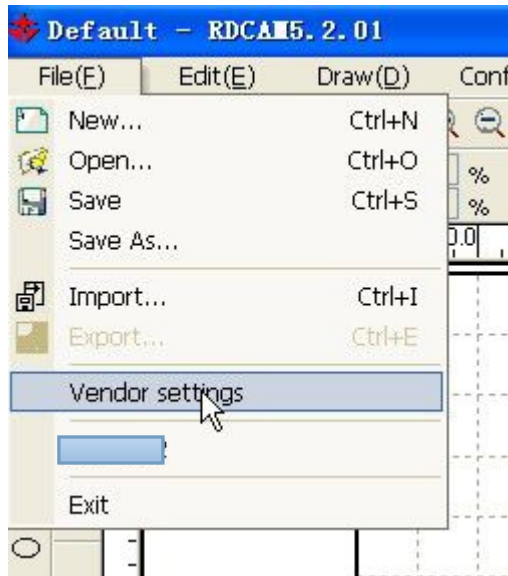

A. Open the software, click 'File' ---'Vendor settings', enter password 'rd8888' and log on.

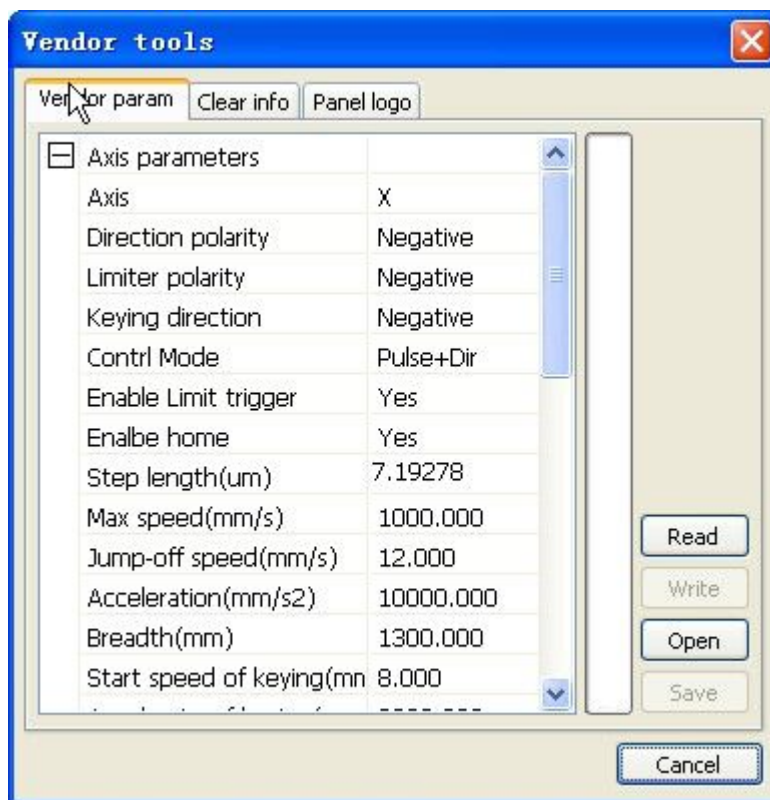

B. Press 'Read', then close dialog box.

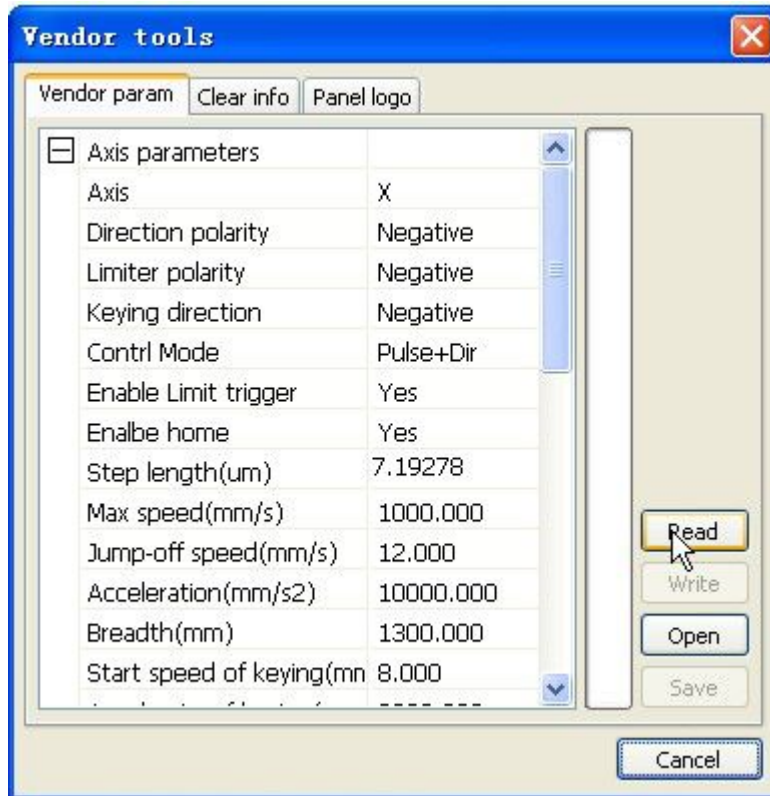

C. Choose “User” on the right side of software, click ‘Read’ and set parameters as shown in the below picture.

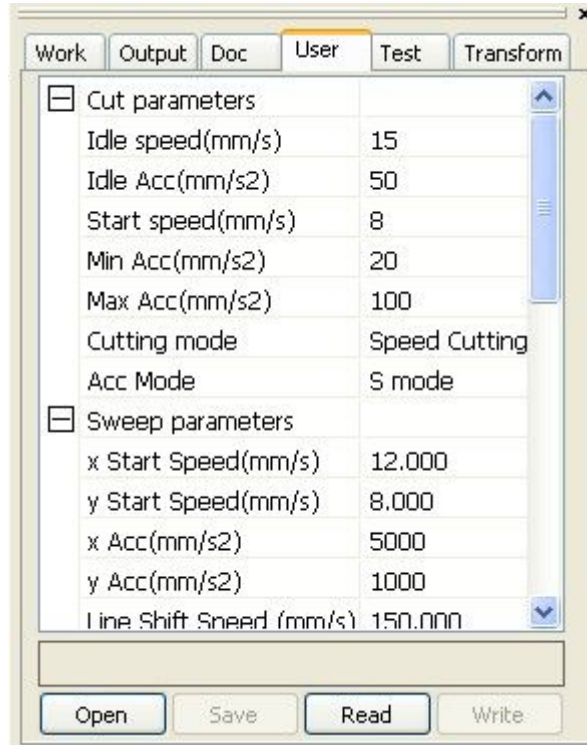

After changing parameters, click ‘Read’.

Attention: Record the original parameters before changing them. Reset them when you don't need rotation axis.



## 2.2 Pulse calculation

‘Circle pulse’ is changing along with the diameter changing of rotary products.

Calculation formula:

Realistic pulse=(theoretical pulse\*theoretical length)/ realistic length

Example: engrave 20mm line on the bottle bottom of 65mm diameter.

(1) Open ‘Output’ menu. Input ‘10000’ in ‘Circle Pulse’ and ‘65’ in ‘Diameter’ as shown in below picture.

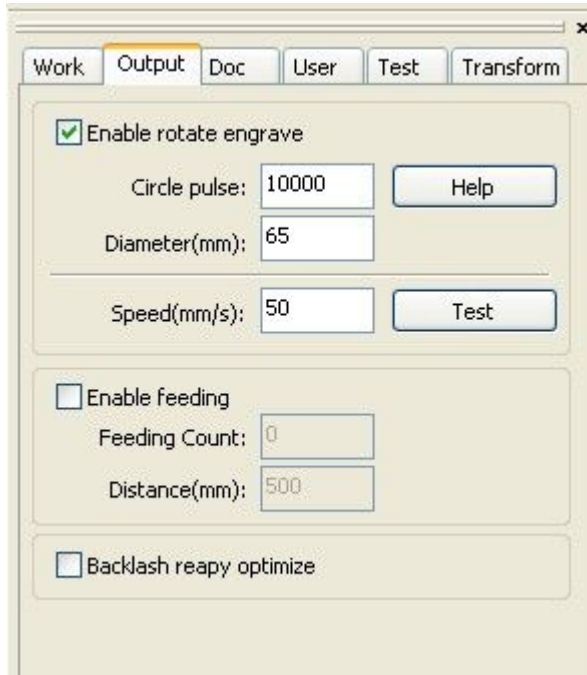

**Attention:** select ‘Output’ and tick ‘ Enable rotate engrave’

‘Diameter’ means the diameter of working material.

(2) Draw 20mm line on the software

On the software, draw 20mm line and set cutting parameters: recommending speed ‘15’, maximum power ‘15’, download.

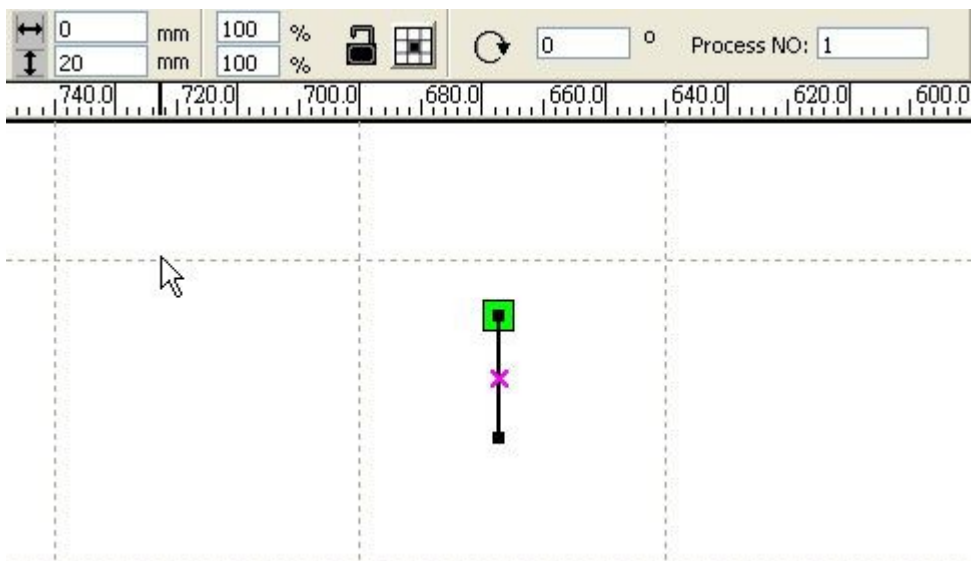

(3) Paste a double-sided adhesive tape along the surface of working object.



(4) Place the rotation axis in right position, adjust the position of the bottle. Pull the beam and make the laser head upon the bottle.



**Attention:**

**Confirm the position of rotation axis placing:**

Press direction button on the panel. If the direction of driving wheel in rotation axis is opposite to the button-pressing direction, it is the right position. The working shape is mirror image if the position is wrong. Just turn 90 degrees of rotation axis.

(5) Start to work after adjusting focus



(6) Measure the length of cutting line

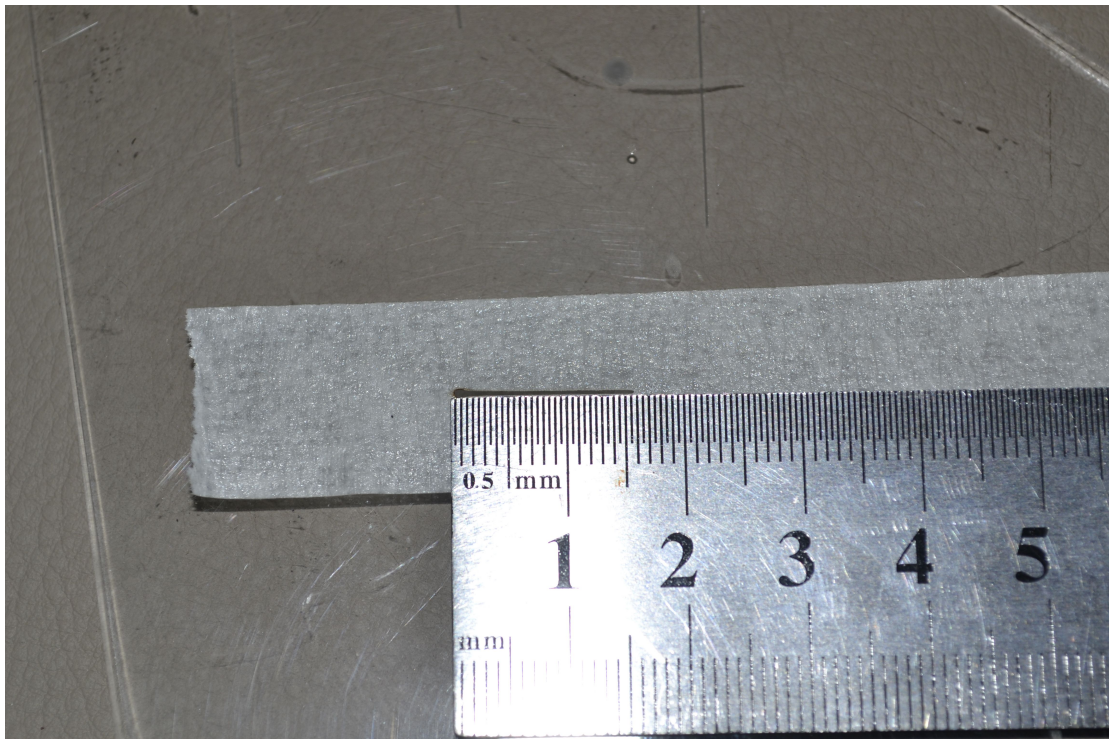

Measuring length is 16.5mm and is not identical with 20mm on software. So Circle Pulse(10000) is not correct.

(7) Change Circle Pulse

According to the calculation formula--- $\{10000 \times 20\} / 16.5 = 12121$ , you can get the actual pulse 12121.

Input the calculated pulse and the object diameter.

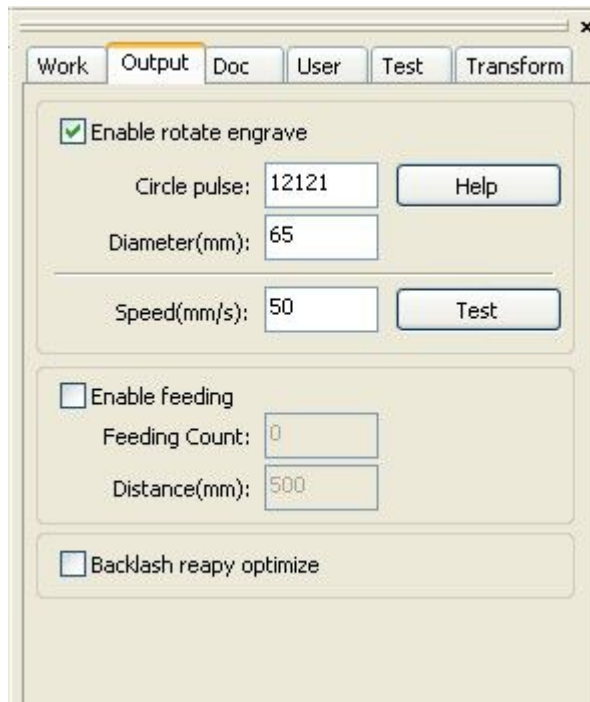

### 3. Attention

When you don't use rotation axis, please set the parameters in "User" to original

parameters and remove tick  before  Enable rotate engrave .

**Tips: The placement direction of rotation axis can affect cutting effects. A wrong direction placement can result in a reverse effect.**

## VI Simple operation instruction

Before operation, please electrify the equipment, then connect the machine USB and computer USB with USB data line.

### 6.1 Software installation

A. Double click on 'RDCAMSetup6.exe' in the disk catalogue. Below dialog box will show up.



B. Click **【Install】** button. Installation interface shows up after unzip and copy operation.



C. Click **Install USB driver** . The following dialog box shows up.



D. After confirming USB data line is connected well, click **“OK”** . The following dialog box shows up.



E. After installing USB drive, click  to install software.

After that, the following dialog box will show up and indicate that the software has been installed successfully.



F. After finishing all installations, click  to end up installation process.

The user may need to install some different softwares (install external software while installing LaserWork). So after finishing all installations, the dialog box cannot close automatically. The user can end up installation by clicking  button.

## 6.2 Data line using operation

Before operation, the machine has been started. All accessories such as water chiller and pump can function well.

### 6.2.1 Read parameters

Different machines have different versions.

The purpose of reading parameters is to match “Supplier Parameter” and “User Parameter” in main board with parameters in software.



A. Click “File” , then open “Vendor settings” .

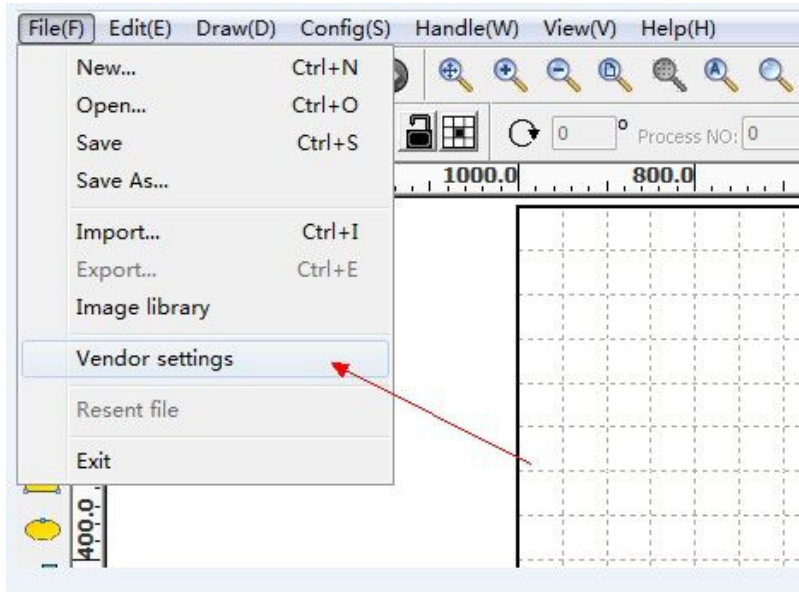

B. Input password “rd8888”.



C. After entering interface, click “read” .

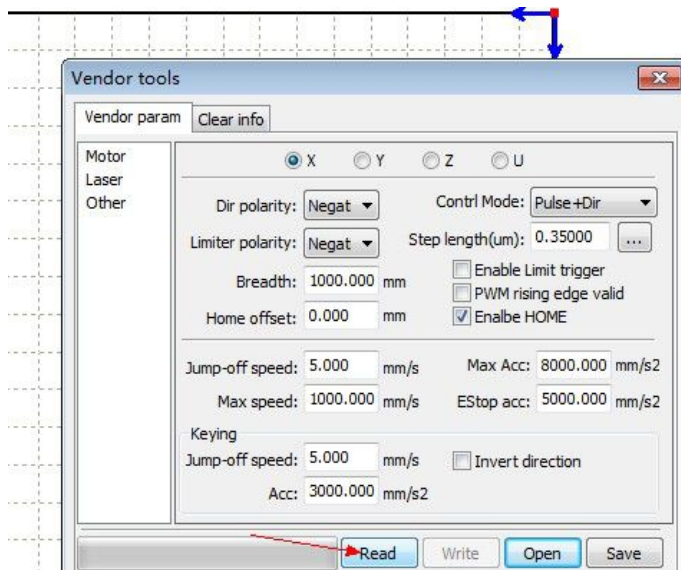

D. Click “user” as shown in the following picture.  
Click “read”.

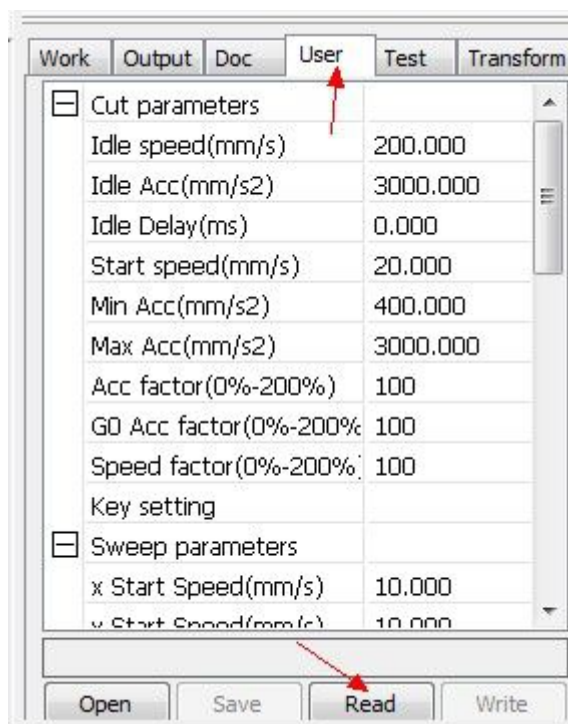

Attention: if changing main board or parameters, please first go through“read”. Then find parameters of CD or U disk and go through “open” and “write” .



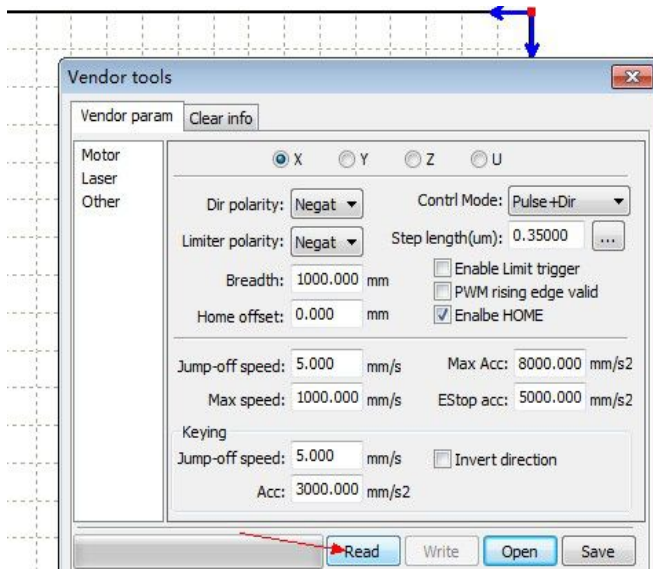

E. In the U disk or CD along with the machine, find the file folder named by machine serial number.

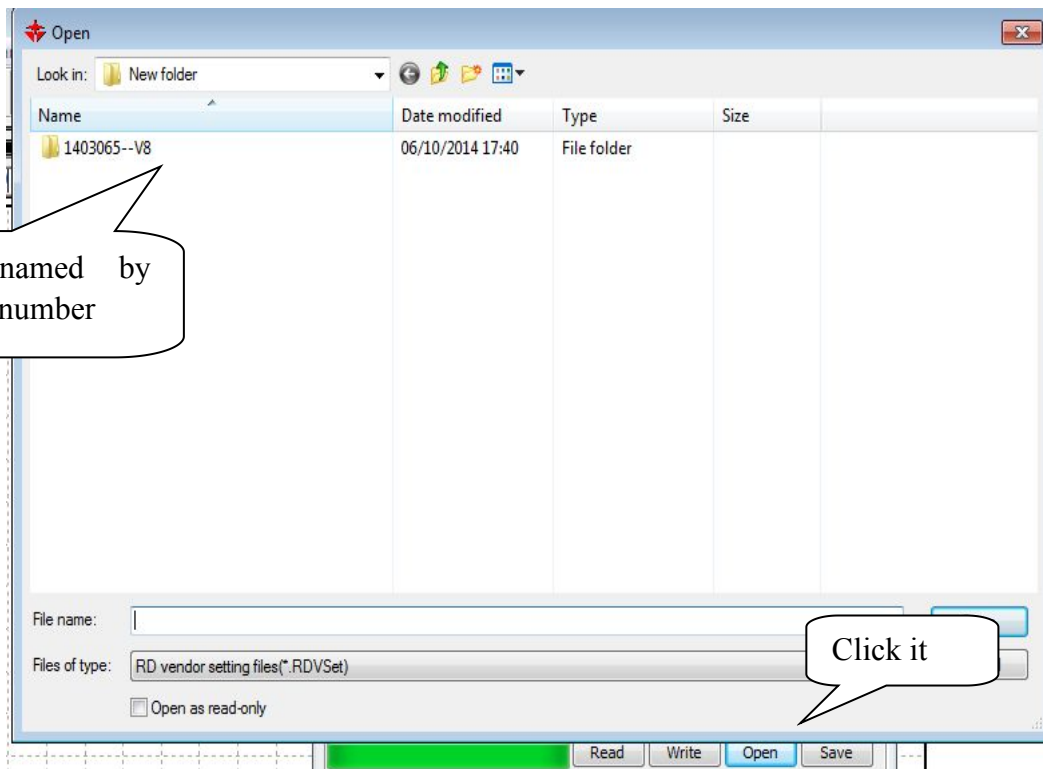

F. After that, “CHANGJIA.RDVSet” file shows up.

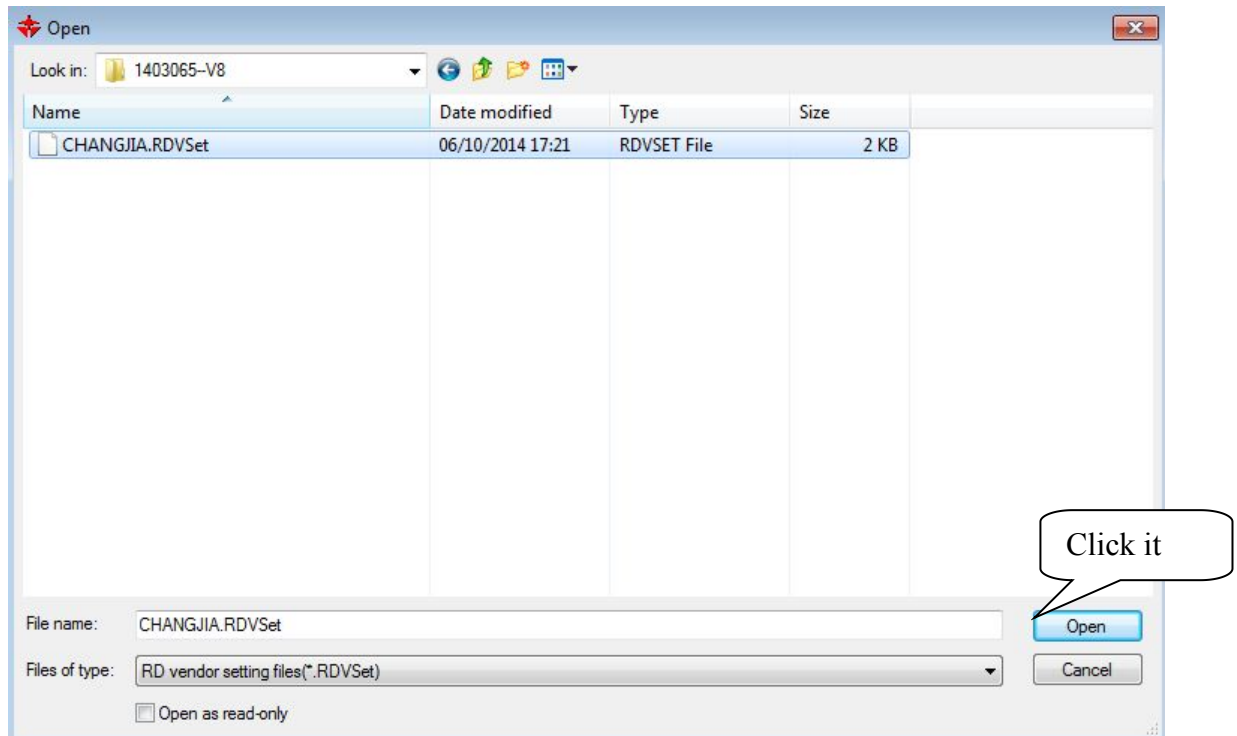

G. After opening it, “Import param success” shows up.

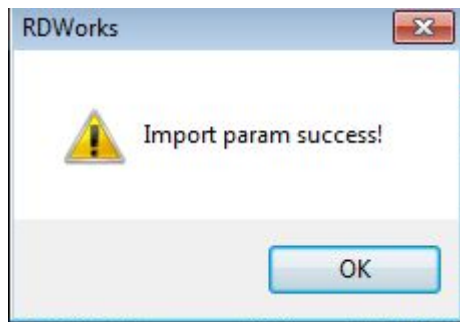

H. Click “用户” as shown in the following picture.

According to the supplier’s setting mode, follow the sequence of “read” — “open— “write” to import user parameters.

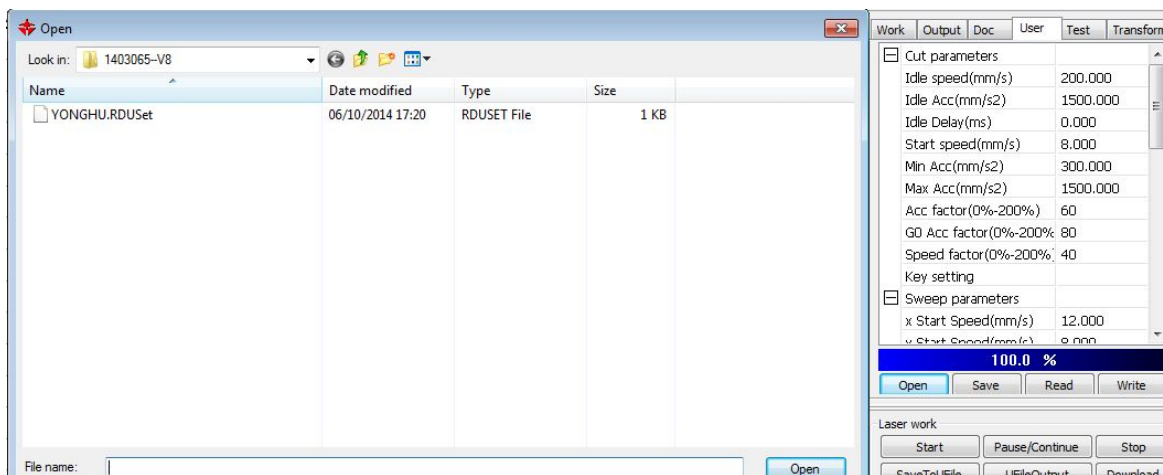
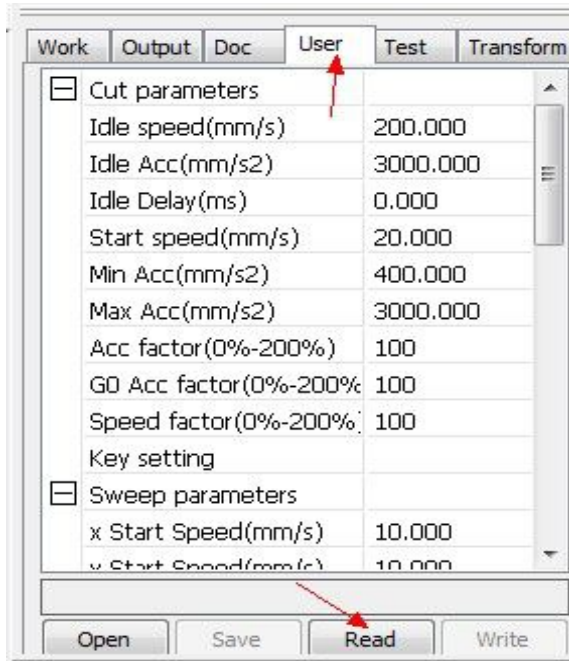

I. After importing parameters of the supplier and user, close the software. Reopen the software, you can use it normally.

### 6.2.2 Make simple pictures&Set picture layers

A. In the software, choose “Rectangle” and draw a simple square. Then modify the size.

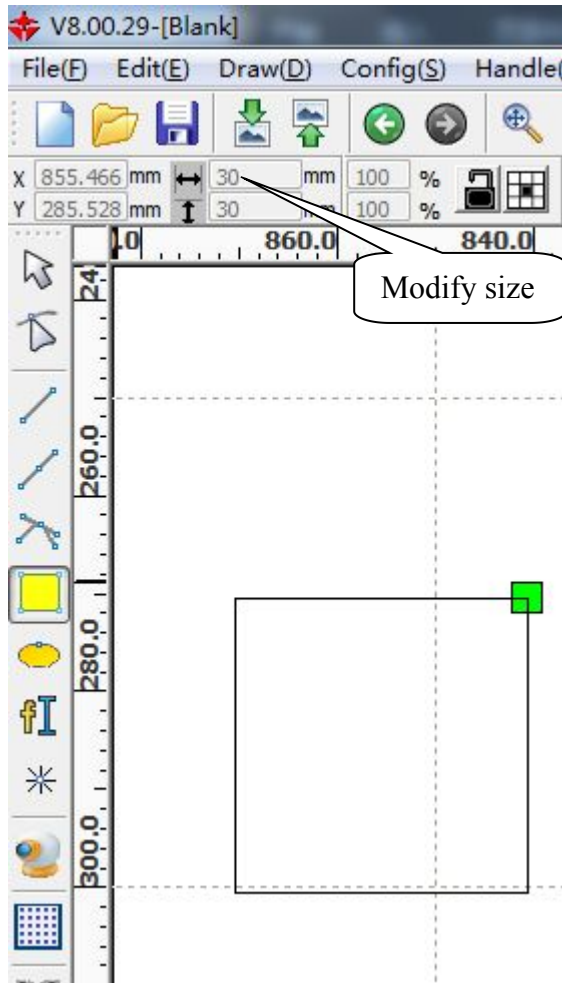

- B. Click “script”.
- Click once in the drawing zone.
- In the dialog box, edit text and click “OK”button.

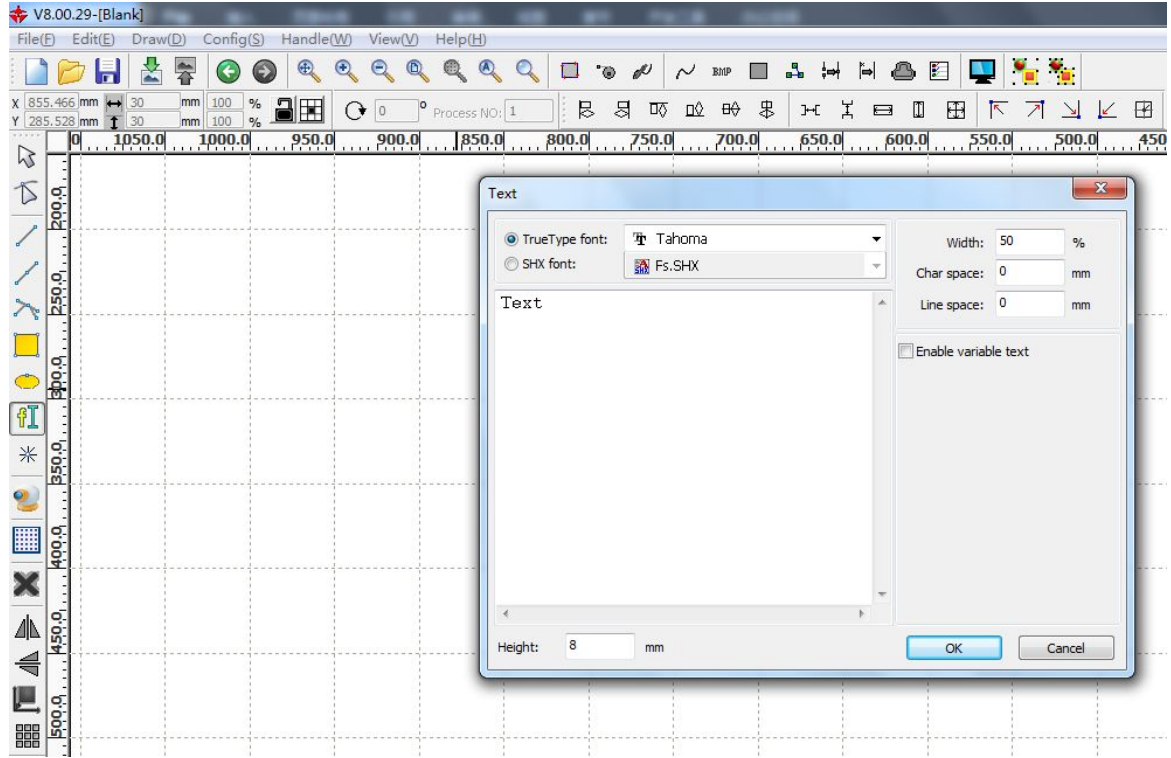

C. After choosing text by frame, select picture layers.

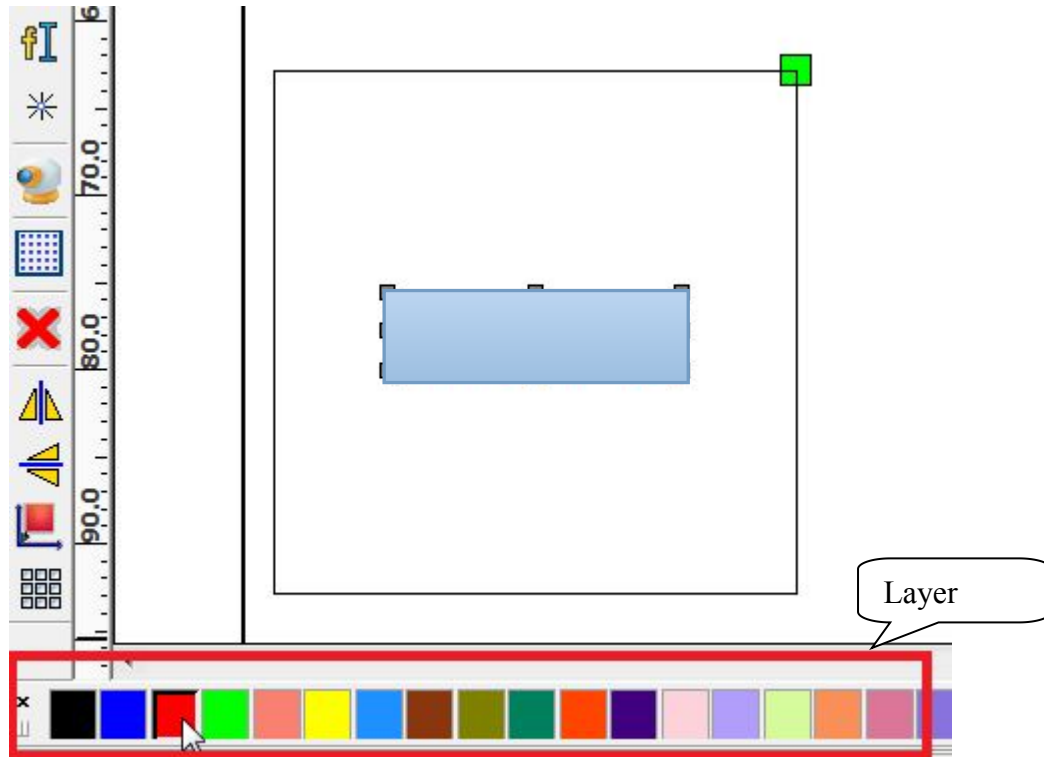

### 6.2.3 Set working mode

According to cutting material, set power and speed. (Cutting parameter sheet can be for reference)

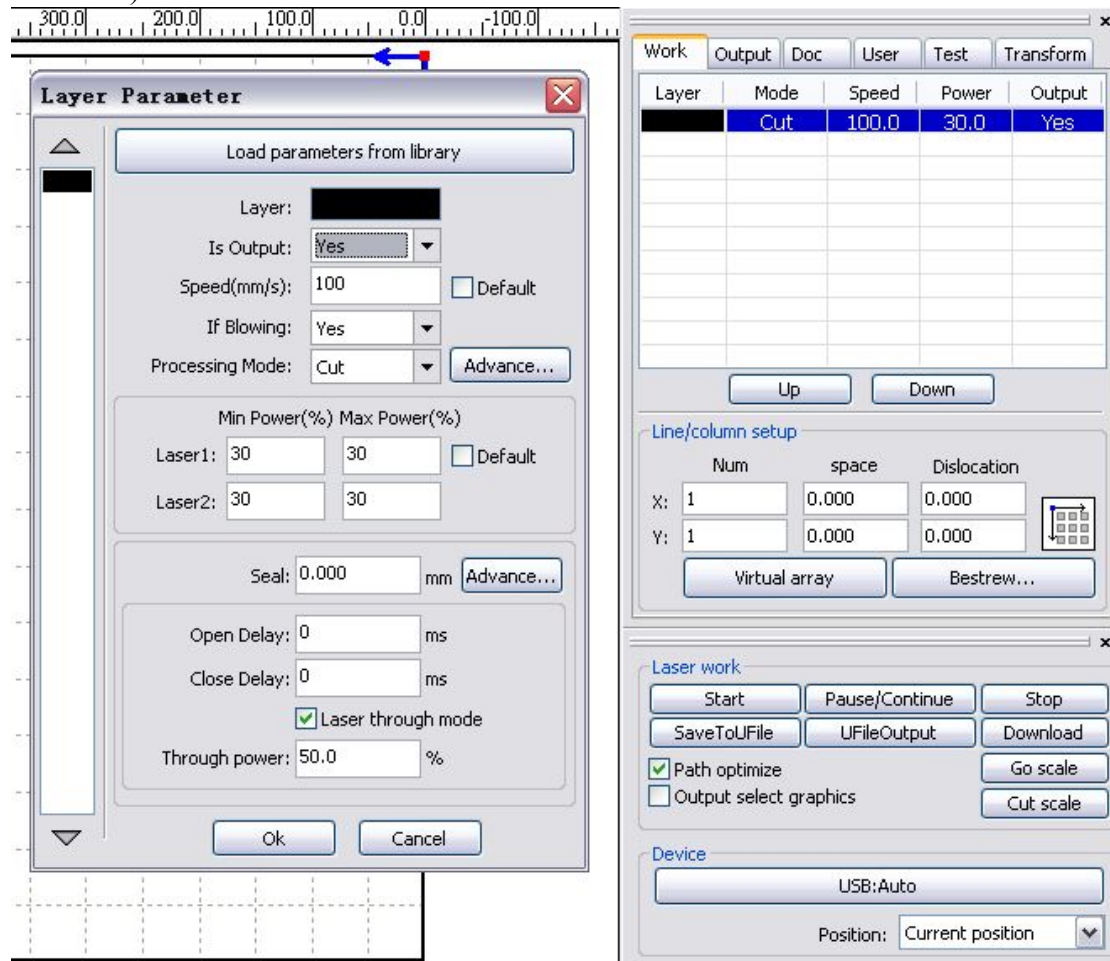

### 6.2.4 Download file

Click "DOWNLOAD".

Name the file.

Click "OK".

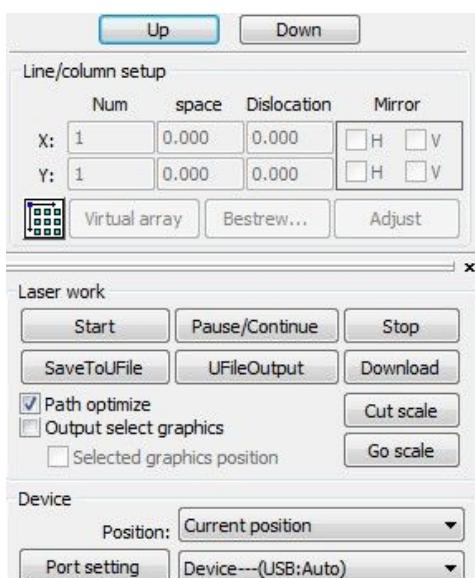

### 6.2.5 Machine operation

1. On the machine, find downloaded file by pressing “file” button as shown in the picture.



2. After finding named file, press “Enter” button.

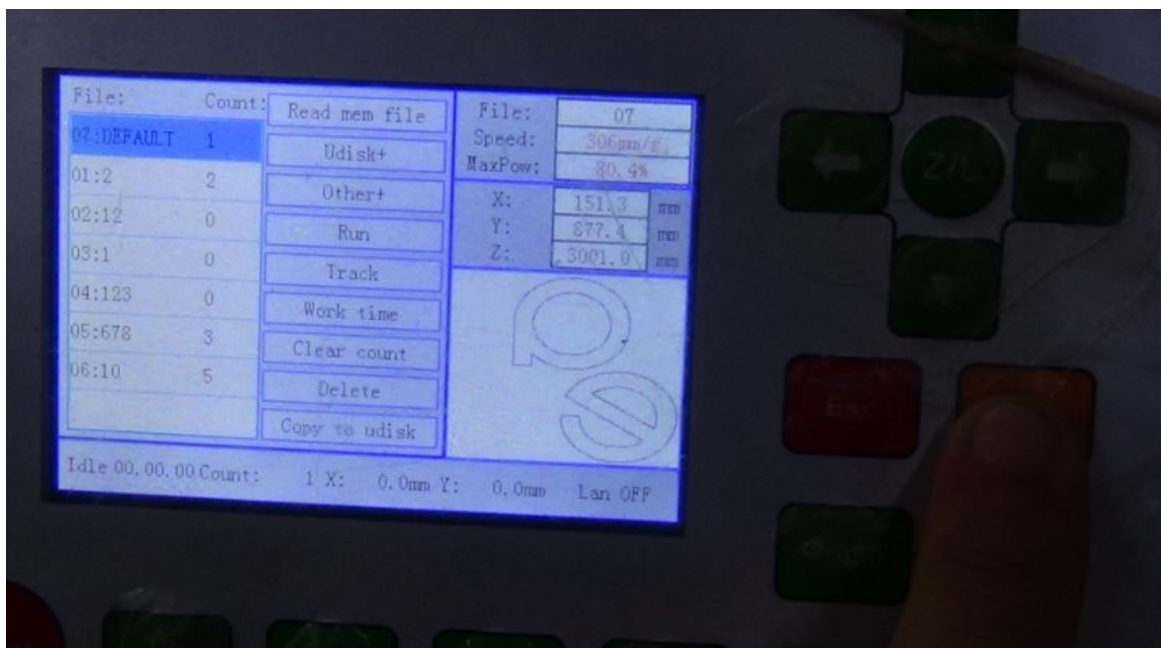

3. put cutting material well and adjust focal length well.

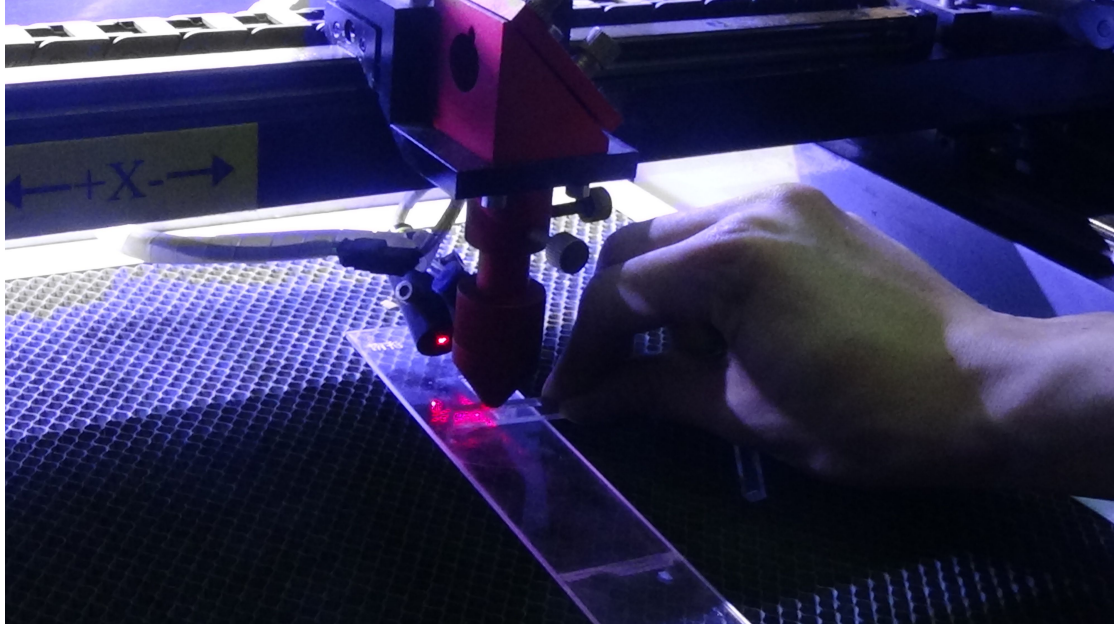

4. find the right place ,press “origin”button to frame cutting area. Then press “start”button. Then you can see the machine is cutting material as shown in below picture.





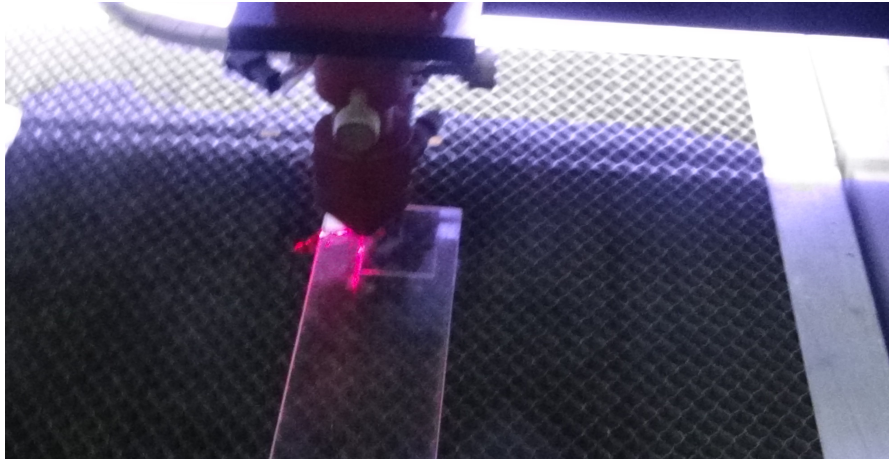

### 6.3 U disk operation

Same operations with data line will not be listed again.

1. After setting power, speed and cutting method, click “Save as offline file” and shows dialog box. Name the name of the file. Then click and save “USB drive”.

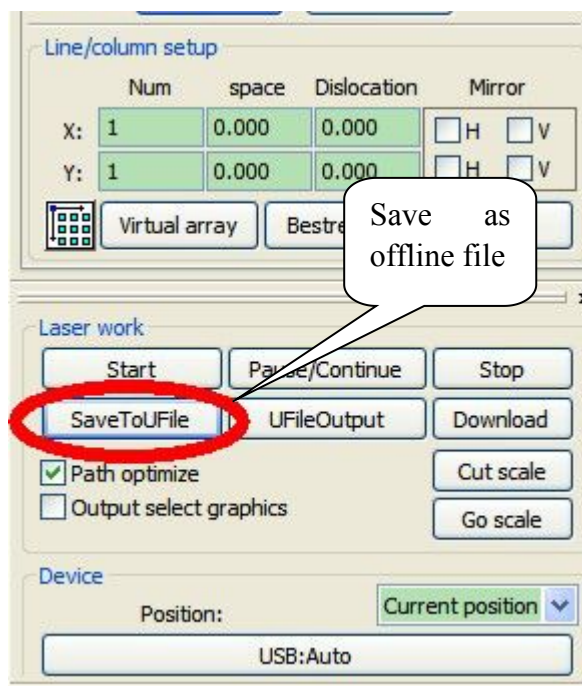

2. In the file location, find the file and save it to U disk.

3. Insert U disk to the interface of the machine.



4. Choose “读 U 盘文件” and press “确认” button.

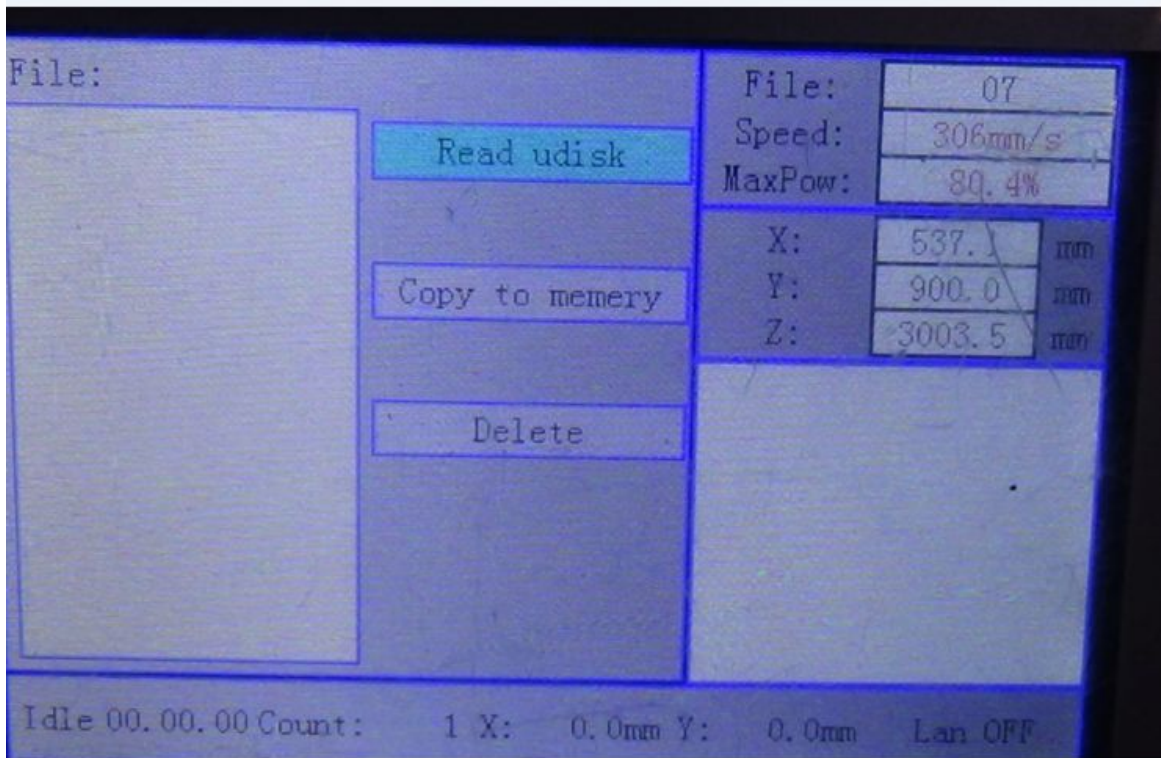

5. After choosing the file, then choose “copy to memery” and press “OK” button. Below picture will show.

Attention: if there is a file in the machine which has the same name as the file in U

disk, the copy operation will not be successful. It will be ok if you rename the file in the machine.

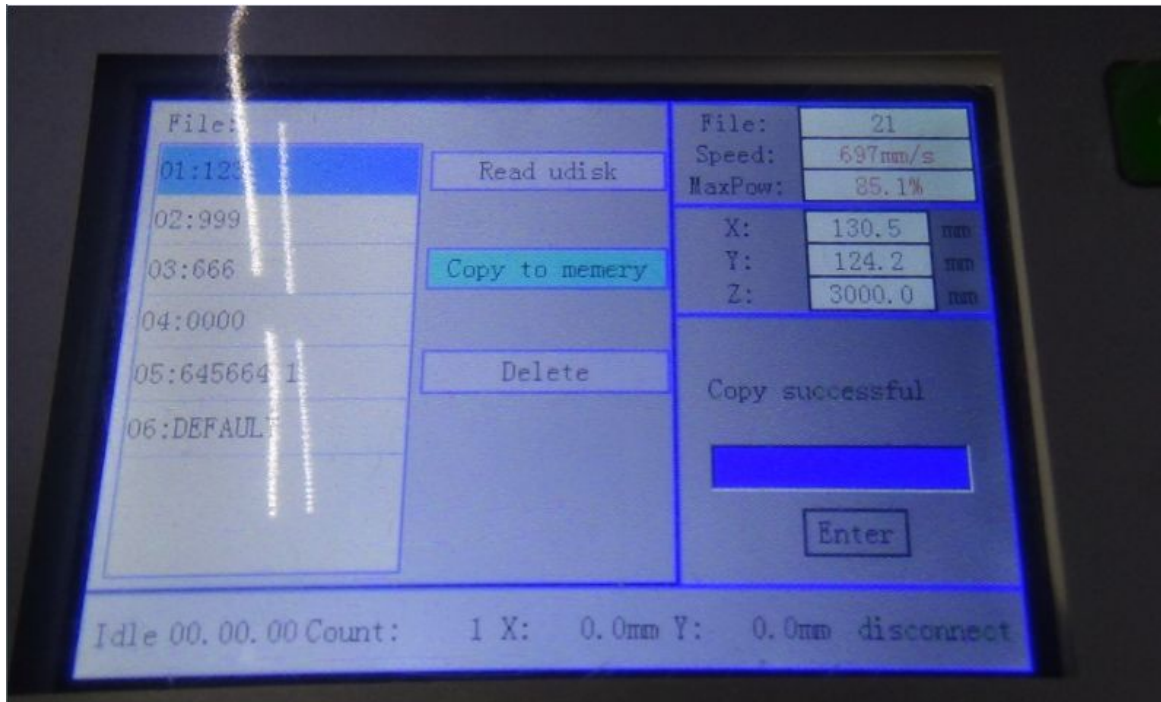

6. In the machine, find the copied file. You can go through working operation.

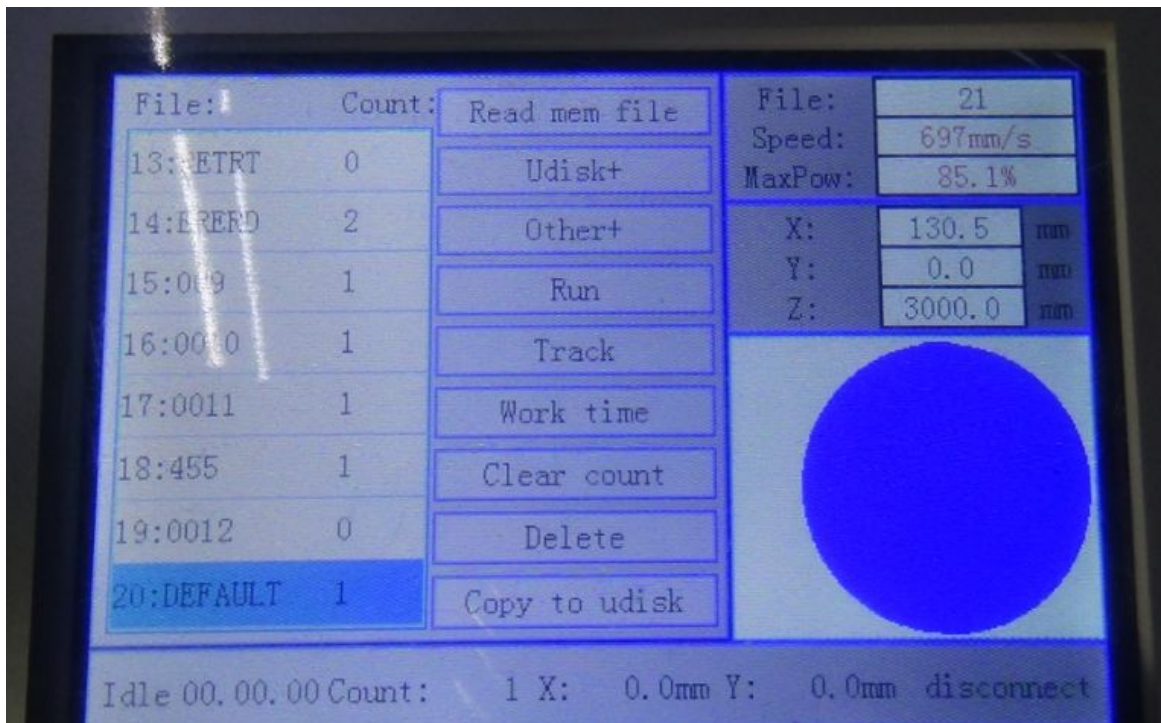

## **VII Equipment's maintenance**

### **7.1 Daily maintenance**

Equipment's working environment could not be too severe. If temperature is higher than 30°C, lower than 18°C, and if there is too much dust, with severe air pollution, then the machine could be badly damaged, failure rate goes up steadily. Various electric parts are easily damaged under wet environment.

### **7.2 Water tank's change and clean**

We recommend to clean water tank and change the circulating water per week.

Attention: Before starting the machine, there must be full of circulating water and no bubble in laser tube.

The quality and temperature of circulating water have a direct influence on life time of laser tube. We recommend to use purified water and control the water temperature under 35°C. If the temperature is over 35°C, you need to change circulating water or put ice in the water to cool down water temperature. (Recommend the customer to use water chiller or two water tanks )

Clean water tank:

firstly, switch off electric power, take off the water-inlet water tube to let water inside laser tube go to water tank. Open water tank, take out water pump, clean dirt on it. After cleaning water tank, changing new recycling water, put back the water pump. Connecting water tube on pump to water-inlet gate, and other joints. Connect electric power to water pump separately for 2-3 minutes(make laser tube be full of recycling water).

### **7.3 Exhaust fan's clean**

After long term's using of exhaust fan, it would accumulate much solid dust, which could make exhaust fan produce big noise and it is also not good for eliminating wasted air and smell. When it occurs that exhaust fan is not good enough to suck and eliminate air, firstly close the power, take off air-in and out tubes, remove dust inside, bottom up the exhaust fan, roll fan blades inside until it's totally cleaned. Finally, set up the exhaust fan.

### **7.4 Reflector's and lens' clean**

We suggest to clean the reflectors and lens, before starting the machine everyday, while the equipment should be under power off situation.

There are 3 reflectors and 1 lens on Laser equipment(The first reflector is set on emission exit of laser tube, means on the laser equipment's upper-left side. The second reflector is

on the left side of transom. The third one is on the top side of laser head, lens is inside of lens cone). Laser beam is transmitted through these reflectors and lens. It's easily for mirrors to smear dust and other dirt, which could result in laser's loss or mirrors' damage. The first and second reflector needn't have to be taken off when do cleaning. Take lens wiping paper with leaner to wipe reflectors from center to edge. The third one and lens need to take off from lens frame and clean them with same way, and put back after finishing.

Attention:①wipe the reflectors and lens softly, do not damage their surface coating film;②handle gently during wiping to avoid falling down;③ the convexity side must be arranged downward.

## **7.5 Guide rail's clean**

We suggest to clean the guide rail every half a month when the machine is powering off. As key parts, guide rail and straight line axis play role of guiding and supporting. In order to guarantee higher processing precision, higher requirement for guide rail's guiding accuracy and straight line axis' moving stability. During processing, the material processed can produce much corrosive dust and smog. After long term acceleration of these dust and smog on guide rail and straight line axis, equipment's working precision can be affected and can also form corrosive spot on them, thus shorten machine's lifespan. For maintaining equipment's normal and stable work, make sure the products' processing quality, please do well in guide rail and straight line axis' daily maintenance.

Attention:For cleaning guide rail, please prepare dry cotton cloth, lubricating oil(sewing machine oil can be adopted)

## **7.6 Light path's examination**

Laser engraving equipment's optical system consists of reflectors' reflection and lens' focusing. In light path, lens doesn't exist excursion, however, the three reflectors are fixed through machinery, so possibility for excursion can be huge. Generally speaking, the excursion of light path could seldom happen, we suggest users to test it before everyday working.

## **VIII CO2 glass laser tube's precautions for use**

**8.1** Before using, please connect the water pump/chiller first, adopts lower side-in and higher side-out principle, adjust water-outlet tube's position, guarantee cooling water is full of cooling tube. There should be not any bubble inside the laser tube, then power on.Requirement: cooling water should be soft water(distilled water or pure water). Water temperature should be frequently examination and should be within 12-30°C. It should not be too low or too high, especially in summer. Once water's temperature is too high, you should change cooling water in time or stop the equipment for some time. Users in

cold area should guarantee water should not be freeze, especially when machine stops working, cooling water must not stay inside in laser tube in case there is any frozen cooling water to cause explosion.(Special attention: For users who use AC, cooling water must be connected with ground)

**8.2** The two supporting points should be on the 1/4 part of laser tube, and water-flow should be at the level of 2L-4L per minute. Otherwise the effect is not good, which could lead to mode hopping. Small change of facula will result in the decrease of power. Cooling water's water-outlet tube must be submerged in water, or there will occur laser tube is not filled totally with water when the machine is powered off and on.

**8.3** Pay attention to protect laser tube's exit side, to avoid smog sputtering on the exit surface and pollute it during the process of machine working or laser path adjusting. Or power will be lower down. The outside of laser tube's exit side can be cleaned by absorbent cotton or cloth dipped with alcohol.

**8.4** During the debugging, the best output effect can be reached through adjusting laser tube's supporting position or rotating laser tube's direction, then fix the laser tube.

**8.5** Careful attention: avoid dust acceleration on high voltage electrode and keep dry. Be away from metals as much as possible in case any fire hazard.

**8.6** During using laser tube, there should be no scale inside laser tube in case to cause water plugging and affect cooling effect. Once there is any scale, use 20% diluted hydrochloric acid to clean cooling tube to eliminate scale.

**8.7** Laser tube belongs to glass products, fragile. Avoid local stress when arranging laser tube.

**8.8** Use laser tube properly and save laser power. Laser tube's best power is 80% of rated power.

## IX Common Breakdown Maintenance

Symptoms	Problem analysis	Processing method
No laser beam during working	1.Firstly, check if laser tube itself works normally(the exit of laser),if it works normally	Test if mirrors are damaged and light path is skewing.
	2.The exit of laser tube has no laser, then check if water recycling works normally(see if water flow is smooth), if there is no water flow or it's not smooth	clean water pump, dredge water tube

	3. Water recycling is normal, then check if laser power guiding light is bright or not, fan rotates or not, if not	Laser power is bad and needs to be changed
	4. Press "laser", if there is no light	Laser power or laser tube has problem
	5. If there is light after pressing "laser"	Water protector goes bad and needs to be changed
	6. Short circuit water protector. But there is still no light	Main board or wire board has problem and needs to be changed
<b>Scanning becomes shallow</b>	1. Check working light's intensity and speed, if speed is too fast, intensity is small and water temperature is too high	Enlarge light's intensity, lower down speed and change recycling water
	2. Check depth of crisping, and see if it's normal, if it's normal,	Increase graphics resolution or scanning precision
	3. Crisping is still shallow, or both occasionally,	Check if mirrors are dirty or damaged, light path is skewing
	4. Connect ampere meter, if it can reach 20MA, but the depth is still shallow	Laser tube is aging and needs to be changed
<b>Light is not stable, sometimes has, sometimes does not</b>	1. Check if the mirrors are too dirty or if they are damaged, light path is skewing or not	Clean or change mirrors, adjust light path
	2. Mirrors' light path is normal, then check if water recycling is normal or not, if it is not normal,	Clean or change water pump, dredge water tube
	3. Water cycling is normal, it's may water protector's problem	Change water protector
	4. If problems remain, main board, laser power, laser tube, all possible to lead to this phenomenon	Change all parts above alternately, and check the reason
<b>The size of output graphics is not right</b>	1. Check "Coreldraw" and see if Graph Plotter unit is 1016 when it outputs PLT	Change graph plotter's unit to 1016
	2. See if resolution ratio is right or not	Recount resolution ratio
<b>Equipment reset is abnormal</b>	1. The direction is right when reset, but when reaching the vertex, the transom can not stop (if new machine, please check main board's parameter first, if it's right)	Check if it's stuck during moving. If yes, main board and tool sensor has problem, needs to be changed
	2. Transom resets normally, laser head doesn't move, maybe tensioner gets stuck or motor axis breaks, parameter is wrong	Change tensioner or small motor, modify parameter, check motor line's clip

	3.Contrary to transom's movement, and strike the side	Main board parameter is wrong. Stop the machine and modify main board parameter. Re-down load configuration
	4.Drivers or Motors' problem	Change drivers or motors
<b>Equipment stops engraving, skips engraving or engraves wrongly</b>	1.Check equipment's grounding situation, and check grounding line is standard or not(resistance to ground should not be bigger than 5Ω)	Modify grounding line to reach standard requirement.
	2.Check if the original pattern has mistake, such as graphs are crossed, not closed, or lack something	Correct mistakes in patterns
	3.If other patterns don't have this problem, only some one has such problem	Patterns and date mismanage. You need to make working sketch again
	4.If problem still remains	Maybe it's computer's serial port issue. It's engraver's main board's problem

## Appendix 1

### 《After-sale warranty of Laser Engraving Cutting Machine》

First of all, thank you very much for purchasing Bodor products. In order to guarantee the smooth processing of after-sales service, we will make the following announcements:

#### General principles

1. We are responsible for the maintenance of facilities which are within the Warranty conditions.
2. Users must keep the machine's integrity and independence during operation. In the following situation, our company will not take any direct, indirect or joint liability. Furthermore, if any equipment is damaged or there are any losses in either economic or



reputation to our company due to the following situation. we, Bodor company, reserve the right to investigate any legal liability.

- (1) Using the equipment in an environment that it was not designed for.
  - (2) Altering the machines privately, including, adding parts, reducing parts, dismounting, using another brand's parts, etc.
  - (3) Human damage or doing operations and maintenance without following the requirements in the instructions.
  - (4) Damage caused by movement or transportation.
3. On condition of not influencing the machine's performance, our company reserves the right to change the product's specifications and name the products before informing the customer.
4. Our company is responsible for the quality and performance of the machine we sell. However, we are not responsible for other indirect obligations and responsibilities.

### **Detailed Principles**

1. Equipment Warranty: 2 years. Calculated from the production date in machine's nameplate.

2. Laser module warranty:

(1) RF Tube's and fiber module's warranty: 1 year

(2) Standard CO2 Glass Laser Tube's warranty:

40w ~ 80w: 4 months

100w ~ 150w: 6 months.

(3) RECI Laser Tube's warranty: 10 months .

(P.S. Laser module's warranty date is calculated from the production date in laser module tag. CO2 Laser Tube is suggested to be used in nonmetal and opaque materials engraving and cutting. Improper use will cause the front lens to breakdown. Any breakdown of the front lens and an incomplete laser tube will not be guaranteed.

3. Consumable parts warranty:

The warranty does not include consumable parts, such as glass mirrors, belts, switches, gas nozzles ,foots/wheels, keys/press boards, etc.

The warranty of power supply and drive is 1 year.

4. Warranty of peripheral devices (if the machine has them):

Warranty of peripheral devices is 1 year, calculated from the production date in the device's tag. Maintained by device's manufacturers as per their standard, Our company assist maintenance. Peripheral devices include water-chillers, fans, air pumps, water pumps etc.(If the machine has them).

### **Accessories repair and shipping cost**

#### **Within the warranty period:**

For free repair or replacement of accessories, the buyer should bear the shipping costs from their local place to our company if it needs to tested, repaired or replaced.

If the failure cause by the quality of parts after testing(non human and use environment factors etc.), it will be repaired or replaced free of charge, and Bodor company will bear the return shipping cost.

The repaired parts should be returned to our factory. After we test and repair the part, we will give it back to the buyer. ( if the buyer is in arrears of spare parts, Bodor company will cancel the warranty terms of the machine).

If the failure is not caused by the quality of parts, the buyer should pay the repair fees and round-trip shipping cost.

**Outside the warranty period:**

The buyer should pay for repairs and round-trip shipping.

**Door to Door Service Policies**

Bodor supplies door to door service all over the world. Charging standards and service processes are as below:

**(A). Charging standards:**

1. Technician visa fees, domestic travel expenses (including transportation cost occurred during handling documents);
2. Training and maintenance fees: \$100/day/person ( take the time of landing and starting off of plane in customer’s country as standard ) ;
3. International round-trip tickets (reserved and paid by the buyer, and supply the e-ticket information to our company );
4. Abroad accommodation(arranged and paid by the buyer)

**(B).Overseas training/maintenance processes:**

1. Bodor company will calculate the fees of item 1 and item 2 above, and then inform the buyer. After the buyer pays the fees, Bodor company will arrange for the technician to apply for a visa.
2. We will inform the buyer after the technician gets the visa. The buyer should supply the round-trip ticket information mentioned above in item 3, and arrange accommodation from item 4 after the technician arrives.
3. Only after getting the approval of Bodor company, the buyer can apply for an extension for the training and maintenance. The buyers should pay for the“extend training and maintenance service fees”before the start of the extend service.

## Appendix 2

### Cutting and engraving parameters of laser tubes

#### Cutting parameter of 80W laser tube

<b>Material</b>	<b>Thickness</b>	<b>Speed</b>	<b>Working(Max) Power%</b>	<b>Turning (Min) Power%</b>	<b>Application</b>	<b>Remark</b>
acrylic	3mm	10-20	40-70	35-70	cut	
	6mm	5-10	70-80	65-80	cut	
	8mm	2	80	75-80	cut	0.5mm lower than focal block
	10mm	1-2	80	75-80	cut	1mm lower than focal block
cloth or paper	0.5mm	100-400	20-50	20-50	cut	
leather	0.5mm	100-400	35-50	35-50	cut	
double color board	1.5mm	30-50	45-55		cut	
marble		300-600	25-75		engrave	scanning step 0.03-0.1
acrylic		300-600	25-75		engrave	scanning step 0.03-0.1
wood		300-600	25-75		engrave	scanning step 0.03-0.1
double color board		300-600	25-75		engrave	scanning step 0.03-0.1

**Cutting parameter of 90W laser tube**

<b>Material(mm)</b>	<b>Speed(mm/s)</b>	<b>Min Power(%)</b>	<b>Max Power(%)</b>
<b>acrylic</b>			
<b>3mm</b>	<b>10~20</b>	<b>40~68</b>	<b>40~63</b>
<b>6mm</b>	<b>4~5</b>	<b>65~75</b>	<b>60~70</b>
<b>8mm</b>	<b>2~5</b>	<b>60~75</b>	<b>55~70</b>
<b>10mm</b>	<b>2~4</b>	<b>45~75</b>	<b>40~70</b>
<b>12mm</b>	<b>1~3</b>	<b>65~75</b>	<b>60~70</b>
<b>15mm</b>	<b>1~2</b>	<b>60~75</b>	<b>55~70</b>
<b>cloth or paper</b>			
<b>1mm</b>	<b>100</b>	<b>20</b>	<b>18</b>
<b>leather</b>			
<b>2mm</b>	<b>100</b>	<b>28</b>	<b>25</b>
<b>wood or paper MDF</b>			
<b>3mm</b>	<b>30</b>	<b>40</b>	<b>35</b>
<b>6mm</b>	<b>10</b>	<b>40</b>	<b>35</b>
<b>9mm</b>	<b>3</b>	<b>45</b>	<b>38</b>
<b>glass</b>	<b>300~600</b>	<b>18-65</b>	<b>scanning step 0.03-0.1</b>
<b>acrylic</b>	<b>300-600</b>	<b>18-65</b>	<b>scanning step 0.03-0.1</b>
<b>double color board</b>	<b>30-50</b>	<b>40~50</b>	<b>scanning step 0.03-0.1</b>
<b>double color board</b>	<b>300~600</b>	<b>23~30</b>	<b>scanning step 0.03-0.1</b>

**cutting parameter of 130w laser tube**

<b>Material</b>	<b>Speed(mm/s)</b>	<b>Max Power%</b>	<b>Min Power%</b>
<b>acrylic</b>			
<b>3mm</b>	<b>10~20</b>	<b>40~68</b>	<b>40~63</b>

6mm	5~15	40~63	40~63
8mm	2~8	40~63	40~60
10mm	3~6	45~65	45~65
12mm	2~5	38~58	35~58
15mm	2~4	40~65	40~60
18mm	1~3	65	63
20mm	0.5~1	75~80	75
<b>cloth</b>			
1mm	100	20	18
<b>leather</b>			
2mm	100	28	25
<b>wood or paper MDF</b>			
3mm	45	40	35
6mm	18	40	35
9mm	6	45	38
<b>artificial marble</b>	<b>300-600</b>	<b>18-65</b>	<b>scanning step 0.03-0.1</b>
<b>glass</b>	<b>300-600</b>	<b>18-65</b>	<b>scanning step 0.03-0.1</b>

**cutting parameter of 150w laser tube**

<b>Material</b>	<b>Speed</b>	<b>Power</b>	<b>Min Power</b>	<b>Remark</b>
<b>acrylic</b>				

3mm	10-26	40-70	40-60	
6mm	6-15	40-70	40-60	
8mm	5-12	40-63	40-58	
10mm	4--10	45-75	40-75	
12mm	3--8	50--75	45-75	1mm lower than focal block
15mm	2--5	55-75	55-75	1.5mm lower than focal block
18mm	0.8--1.5	55-75	55-75	1.8mm lower than focal block
20mm	0.5--1.2	58-75	58-75	2mm lower than focal block
30mm	0.3--0.8	58--85	58-85	2.5mm lower than focal block

**Attention: above parameters are only for reference, not actual working parameters.**

## Postscript

Bodor reserves the right to explain the terms of the manual. We will try our best to guarantee the accuracy. Due to the limitations of editors, there may be improper mistakes or omissions. And we don't undertake any responsibility for these. We are not responsible for any direct, indirect, special, additional or relevant damage or liability caused by improper use of the manual or the machine. We hope readers can give suggestions and criticism.

Copyright is owned by Bodor. Without permission, none can copy, manufacture, process and use this product and other related parts directly or indirectly. Without permission, none can imitate, copy, extract or translate this user manual. People who violates this requirement will be investigated legal liability.

## 《After-sale warranty of Laser Engraving Cutting Machines》

First of all, thank you very much for purchasing a Bodor product. In order to guarantee the smooth processing of after-sales service, we will make the following announcements:

### General principles

1. We are responsible for the maintenance of facilities which are within the

Warranty conditions.

2. Users must keep the machine's integrity and independence during operation. In the following situation, our company will not take any direct, indirect or joint liability. Furthermore, if any equipment is damaged or there are any losses in either economic or reputation to our company due to the following situation, we, Bodor company, reserve the right to investigate any legal liability.

- 1) Using the equipment in an environment that it was not designed for..
- 2) Altering the machines privately, including, adding parts, reducing parts, dismounting, using another brand's parts, etc.
- 3) Human damage or doing operations and maintenance without following the requirements in the instructions.
- 4) Damage caused by movement or transportation.

On condition of not influencing the machine's performance, our company reserves the right to change the product's specifications and name the products before informing the customer.

Our company is responsible for the quality and performance of the machine we sell. However, we are not responsible for other indirect obligations and responsibilities.

### **Detailed Principles**

1. Equipment Warranty: 2 years. Calculated from the production date in machine's nameplate. Specific details are as below:

2. Laser module Warranty:

- (1) RF Tube's and fiber module's warranty: 1 year
- (2) Standard CO2 Glass Laser Tube's warranty: 40w ~ 80w: 4 months ; 100w ~ 150w: 6 months. Warranty of related laser power supply is one year.
- (3) RECI Laser Tube's warranty: 10 months .Warranty of related laser power supply is one year.

(P.S. Laser module's warranty date calculated from the production date in laser module tag. CO2 Laser Tube is suggested to be used in nonmetal and opaque materials' engraving and cutting, and should be kept clean. Improper use will cause the front lens to breakdown. Any breakdown of the front lens and an incomplete laser tube will not be guaranteed.

3. The warranty does not include consumable parts, such as glass mirrors, belts, switches, gas nozzles, feets/wheels, keys/press boards, etc.

4. Warranty of peripheral devices (if the machine has them):

Warranty of peripheral devices is 1 year, calculated from the production date in the device's tag. Maintained by device's manufacturers as standard, Our company assist maintenance. Peripheral devices including water-chillers, fans, air pumps, water pumps etc. (If the machine has them).

### **Accessories repair and shipping cost**

**Within the warranty period:**

For free repair or replacement of accessories, the buyer should bear the shipping costs from their local place to our company if it needs to be tested, repaired or replaced.

If the failure is caused by the parts' quality after testing (non human factors and use environment etc.), it will be repaired or replaced free of charge, and Bodor company will bear the return shipping cost. If the failure is not caused by the parts' quality, the buyer should pay the repair fees and round-trip shipping cost.

P.S. The repaired parts should be returned to our factory. If the buyer is in arrears of spare parts, Bodor company will cancel the warranty terms of the machine).

**Outside the warranty period:**

The buyer should be paid for repairs and round-trip shipping.

**Door to Door Service Policies**

Bodor supplies door to door services all over the world. Charging standards and service processes are as below:

**(A). Charging standards:**

1. Technician visa fees, domestic travel expenses (including transportation cost occurred during handling documents);
2. Training and maintenance fees: \$100/day/person (take the time of landing and starting off of plane in customer's country as standard) ;
3. International round-trip tickets (reserved and paid by the buyer, and supply the e-ticket information to our company) ;
4. Abroad accommodation (arranged and paid by the buyer)

**(B). Overseas training/maintenance processes:**

1. Bodor company will calculate the fees of item 1 and item 2 above, and then inform the buyer. After the buyer pays the fees, Bodor company will arrange for the technician to apply for a visa.
2. We will inform the buyer after the technician gets the visa. The buyer should supply the round-trip ticket information mentioned above in item 3, and arrange accommodation from item 4 after the technician arrives.
3. Only after getting the approval of Bodor company, the buyer can apply for an extension for the training and maintenance. The buyers should pay for the "extend training and maintenance service fees" before the start of the extend service.