

WAZER

User Manual

Original Instructions - V5.0

WAZER Water Jet Cutter Main Unit (WAZER V1.5)

&

WAZER Water Jet Cutter Pump Box (Pump V1.5A/V1.5B)

© WAZER, Inc.
141 Flushing Avenue
Brooklyn, NY 11205

CE Declaration of Conformity



We, WAZER Inc., hereby declares that product described in this manual are manufactured and delivered in accordance with following directive:

Machinery Directive 95/16/EC
Electromagnetic Compatibility Directive 2014/30/EU
Low Voltage Directive 2014/35/EU
Restriction of Hazardous Substances Directive 2011/65/EU

and following EN and IEC standards:

EN 60204-1
EN 1829-1/-2
EN/ISO 12100-2010

Declaration of Non-Inclusion



We, WAZER Inc., hereby declares that, to the best of WAZER's knowledge, products and components described in this manual do not contain the chemical substances prohibited by the EU Restriction of Hazardous Substance directive (EU Directive 2011/65/EU), at the time of shipment from the factory.

This declaration is in conformity with the applicable requirements of 6 substances restrictions in EU Directive 2011/65/EU (RoHS recast)

These two declarations are only valid, if the setup of the WAZER Water Jet Cutter is carried out according to the instructions delivered with the machine. If the equipment is modified without the consent of the undersigned, this declaration becomes invalid.

Contents

Introduction	1	Creating Cut Files	82
Important Safety Information	3	Terms of Service & Privacy Policy	82
Signal Words	3	Design Software	82
Safety Symbols	4	Wam Overview	84
Product Safety Label Locations	5	Wam Setup	84
Peelable Labels	8	Registration	84
General Power Tool Safety Warning	9	Logging In	84
WAZER Safety Precautions	11	How to Use Wam	85
WAZER	14	User Interface	85
WAZER Workflow	14	The Virtual Cut Bed	85
WAZER Components	15	Wam Settings	86
How it works	15	Cut File Steps	87
WAZER Systems Dissection	16	Step 1: Import File	87
WAZER Specifications	20	Step 2: Scale and Rotate	89
Machine System Schematics	21	Step 3: Material Selection	89
Setting Up WAZER	25	Step 4: Configure Cut Path	91
Choosing a Location for WAZER	26	Step 5: Set Up Tabs and Leads	91
Unpacking	28	Step 6: Finalize Cut	91
Verify Your Shipments Contents	33	Using the Material Library	93
Install WAZER	34	WAZER Material Library	93
Install Pump Vent Cap	34	Adding and Editing Material Library Entries	93
Water Connections	36	Maintenance	96
Power Cables	48	Maintenance Safety Precautions	96
Anchor WAZER to the Wall	50	Machine Maintenance & Setup Menu	97
Cutting With WAZER	52	Maintenance Schedule	100
Preparation	53	Short Term Service	101
Startup	55	Medium Term Service	107
Start Cutting With WAZER	67	Long Term Service	110
Common things to be Mindful of During Cutting	70	Miscellaneous Procedures	111
Finishing	73	Additional Resources	126
Shutdown WAZER	75	Customer Support	126
Maintenance Between Cuts	77	Decommission	126
Cutting with WAZER Checklist	80	Disposal and recycling of WAZER	127
		Warranty	128

Introduction

Congratulations! You have one of the very first desktop waterjet cutters ever built. This User Manual will help you get started.

Welcome to the WAZER User Manual. Your safety, and the safety of others, is very important. Please read this entire document before setting up or using your new WAZER. The warnings and instructions contained in this manual are for your safety. Failure to follow safety warnings and instructions could result in serious injury or death.

This User Manual must always be kept with WAZER and should remain with WAZER if it is transferred or sold.

This manual contains information that is subject to change. We will work to continually improve the product and experience and update this User Manual. Images are provided for reference and may be slightly different from your product. For the most up-to-date version of this User Manual, as well as other product documentation, notices, and knowledge articles please see our online Resources at www.wazer.com/resources. If you have any questions or concerns, contact our Customer Support.

This Manual Includes:

- **Safety**
WAZER is a powerful system; please read, understand, and follow these safety guidelines to avoid damage or injury.
- **About WAZER**
You will learn about the operating principles of WAZER and familiarize yourself with its components. It may be tempting to skip this section, but understanding these concepts will be helpful every time you use WAZER.
- **Setting Up WAZER**
Walk through the process of setting up WAZER. It is important to follow the instructions here very carefully to ensure the successful operation of your WAZER.
- **Cutting with WAZER**
Learn how to operate your WAZER and walk through making your first cut.
- **Wam / Creating Cut Files**
Prepare your own design for cutting on WAZER using our dedicated Wam software.
- **Maintenance**
Like any tool, WAZER requires maintenance. These sections will instruct you about the basics, and also teach you what to do if you run into problems while cutting.
- **Disassembly and Decommission**
Instructions on how to properly and safely disassemble and decommission WAZER after it reaches the end of life.

WAZER Customer Support is here to help.

If you need help with Maintenance and Troubleshooting, please get in touch with the WAZER Customer Support Team. Visit www.wazer.com/resources or email us at support@wazer.com.

Important Safety Information

Read and Understand User Manual Before Use

-  **WARNING:** Read all safety warnings, instructions, illustrations and specifications provided with this power tool. Failure to follow all instructions listed below may result in electric shock, fire, serious injury, property damage, serious injuries, or death. Always read this entire manual before operating WAZER.

The employer or owner is responsible for compliance with all applicable federal, state and local regulations/codes.

-  Always keep this manual in a safe, accessible location near WAZER during operation and maintenance. Save all warnings and instructions for future reference.

Signal Words

Throughout this document, the product labels, and in other collateral materials, you will come across various signal words. Some of these signal words alert you to safety hazards. These are important to the safety of WAZER users. Others are there to make sure your machine or environment does not suffer any damage. Be sure to familiarize yourself and all other users of the machine with these signal words. Make sure to refer back to this section as needed.

-  **SAFETY ALERT SYMBOL** This is the safety alert symbol. It is used to alert you to potential personal injury hazards. Obey all safety messages that follow this symbol to avoid possible serious injury or death. This safety alert symbol precedes any safety message about risk of personal injury.

It may also have one of the following signal words:

 **DANGER** **DANGER** Indicates a hazardous situation that, if not avoided, will result in death or serious injury.

 **WARNING** **WARNING** Indicates a hazardous situation that, if not avoided, could result in death or serious injury.

 **CAUTION** **CAUTION** Indicates a hazardous situation that, if not avoided, could result in minor or moderate injury.

 **NOTICE** **NOTICE** Indicates a hazardous situation that, if not avoided, could result in property damage.

Safety Symbols

In addition to the signal words listed above, WAZER has various product safety signs and safety labels placed in visible locations. These labels are critical to your safety. You must familiarize yourself and other users with their meaning. Ignoring these labels may result in equipment or property damage as well as physical injury or death.

These product safety signs and labels should be periodically inspected and cleaned as necessary to maintain good legibility. If they are no longer legible, the product safety Labels should be replaced. For product safety labels that are lost or damaged, contact WAZER customer support for replacement labels and recommended installation procedure.

The following symbols may be included on the on-product labels or in this User Manual:



TEAM LIFT

Always use two people to lift heavy components.



HOT SURFACE HAZARD

Avoid contact with hot surfaces during operation.



CUT/SEVER HAZARD

Avoid contact with the Jet or High-Pressure components during operation.



ENTANGLEMENT HAZARD

Avoid contact with components in motion during operation.



ELECTRICAL SHOCK HAZARD

Avoid contact with all exposed electronics during operation.



EYE PROTECTION

Always wear appropriate eye protection to avoid potential injuries to your eyes.



Read & Understand User Manual

Read and understand operator's manual before using this machine. Failure to follow operating instructions could result in death or serious injury.

Product Safety Label Locations



Upon unboxing, you will be greeted with WAZER Main Unit in a state like this. Keep in mind all the warning label locations, as they will convey important safety-related message for anyone operating, maintaining and repairing this machine.



Upon unboxing, you will be greeted with WAZER Pump Box in a state like this. Keep in mind all the warning label locations, as they will convey important safety-related message for anyone operating, maintaining and repairing this machine.

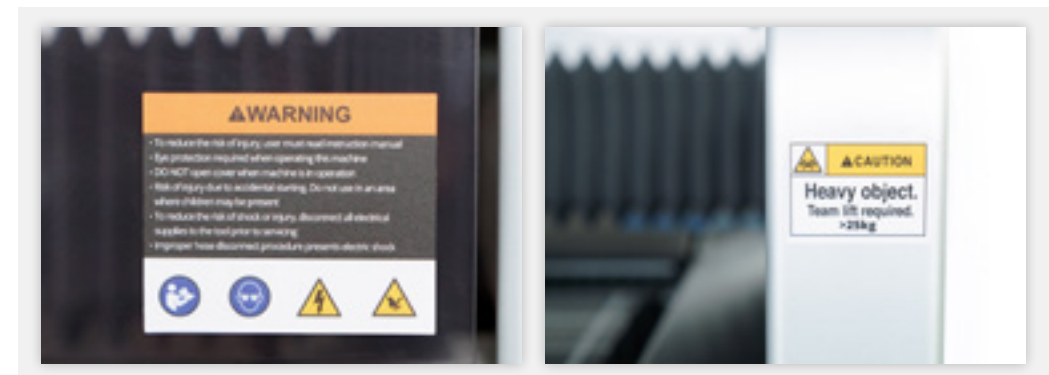

This label warns you of the operation, maintenance, and repair hazards of the WAZER Main Unit.

This label warns you of the heavy weight of the WAZER Main Unit and instructs you to use the proper lifting technique when moving it.



This label warns you of the electric shock hazard associated with an improper hose disconnect procedure. It also serves to instruct you of the proper disconnect procedure.

This label warns you of the existence of the high temperature hazard near its proximity.

This label warns you of the suffocation danger when dealing with plastic bags. Keep this bag away from children.



This label warns you of the residual hazards inside the WAZER Pump Box Electrical Enclosure and instructs for it to not be opened up.

This label warns you of the existence of the high temperature hazard near its proximity. Caution is advised to avoid injury.

This label warns you of the suffocation danger when dealing with plastic bags. Keep this bag away from children.

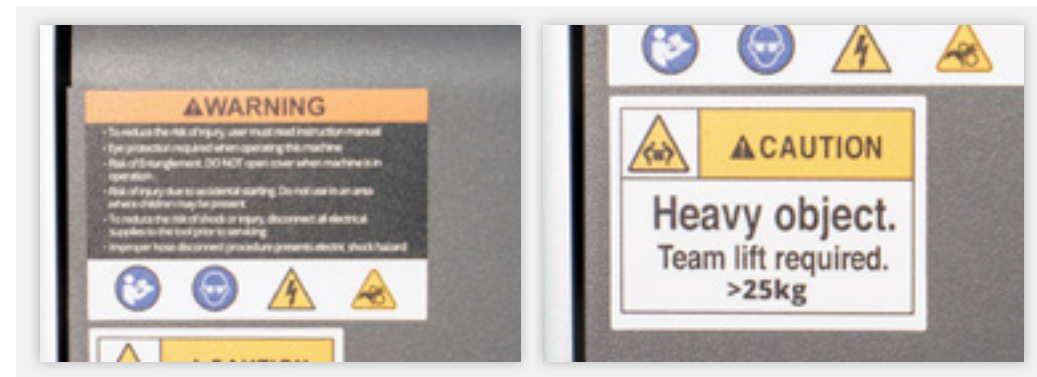

This label warns you of the operation, maintenance, and repair hazards of the WAZER Pump Box.

This label warns you of the heavy weight of the WAZER Pump box and instructs you to use the proper lifting technique when moving it.



This label warns you of the heavy weight of the WAZER packages and instructs you to use the proper lifting technique when moving them.

This label instructs you to the correct orientation that the WAZER packages need to be maintained in at all times.

This label warns you that the WAZER contents inside may contain carcinogenic materials according to the state of California. For more information, visit the listed website.



This label warns you of the electric shock hazard associated with an improper hose disconnect procedure. It also serves to instruct you of the proper disconnect procedure.

This label warns you of the hazards associated with an improper opening of the WAZER Pump Unit. It also serves to instruct you of the proper opening procedure.



This label warns you not to operate the high-pressure hose line under pressure exceeding the maximum working pressure

Peel-able Labels

You may peel them off after the installation process of your WAZER is completed.



This label warns you of the heavy weight of the WAZER Main Unit and instructs you to use the proper lifting technique when moving it. You may peel it off after installation.

This label instructs you to not plug in the power to the machine prior to being sure that all previous steps were completed successfully. You may peel it off after acknowledging our terms of service and installation.

This label instructs you to lift from the correct location when installing or moving the WAZER Main unit to not cause damage to the machine. You may peel it off after installation.

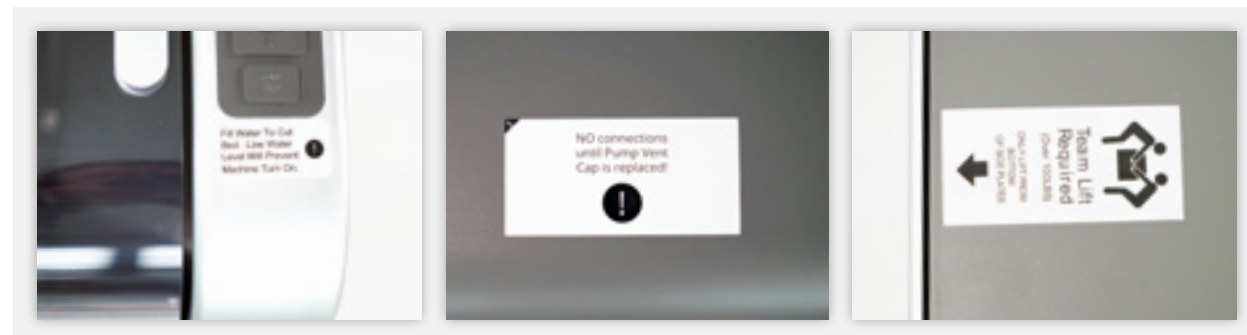

This label instructs you to be sure to fill the WAZER Main Unit to the correct level before expecting it to turn on. You may peel it off after installation.

This Label instructs you to replace the Pump Vent Cap before any connections are made in order to not harm your WAZER Pump Box. You may peel it off after installation.

This label instructs you to the proper lifting technique and locations when installing or moving the WAZER Pump Unit in an effort to not damage the machine. You may peel it off after installation.

General Power Tool Safety Warning

⚠WARNING Read all safety warnings, instructions, illustrations and specifications provided with this water jet cutter. Failure to follow all instructions listed below may result in electric shock, fire and/or serious injury.

Save all warnings and instructions for future reference.

Work area safety

- Keep work area clean and well lit. Cluttered or dark areas invite accidents.
- Set up and operate the water jet cutter where the floor surface and surrounding area are water resistant and slip resistant. Water is likely to spill during routine use, set up and maintenance of water jet cutters. Wet floor surfaces may increase the risk of slip and fall which can result in serious personal injury.
- Water jet cutters must be operated only by persons familiar with their operation and manufacturer's instructions. Operation of water jet cutters by persons unfamiliar with their operation and manufacturer's instructions can result in electric shock, fire and/or serious injury.
- Keep children and bystanders away from the water jet cutter while it is operating, and do not allow unsupervised children and bystanders to interact with the water jet cutter at any time. Other people in the work area may cause distractions, and persons unfamiliar with the operation of the water jet cutter may change its setup, which may increase the risk of electric shock, fire and/or serious injury.

Electrical safety

- Before using the water jet cutter, test all Ground Fault Circuit Interrupter (GFCI) or Portable Residual Current Device (PRCD) provided to ensure they are operating correctly. A properly operating GFCI/PRCD reduces the risk of electrical shock.
- Do not use the water jet cutter with extension cords. The GFCI/PRCD on the machine power cord will not prevent electrical shock from the extension cords.
- Water jet cutter plugs must match the outlet. Never modify the plug in any way. Do not use any adapter plugs with earthed (grounded) water jet cutters. Unmodified plugs and matching outlets will reduce risk of electric shock.
- Do not abuse the cord. Never use the cord for carrying, pulling or unplugging the water jet cutter. Keep cord away from heat, oil, sharp edges or moving parts. Damaged or entangled cords increase the risk of electric shock.
- While operating the water jet cutter, avoid body contact with earthed or grounded surfaces such as pipes, radiators, ranges and refrigerators. There is an increased risk of electric shock if your body is earthed or grounded.
- Before every operation of a water jet cutter, make sure that the water connections and water piping and joints are leak-free. Water leaks may increase the risk of electric shock.
- Because the electronics will be operating around water, both power cables have integrated GFCI/PRCD protection. Do not attempt to use any cables that are not GFCI/PRCD protected.
- DO NOT attempt to use any other Power Supply other than the one included by WAZER
- The replacement of the Power Cables and Power Supply shall only be carried out by the manufacturer or approved service organization.

Personal safety

- Stay alert, watch what you are doing and use common sense when operating a water jet cutter. Do not use water jet cutter while you are tired or under the influence of drugs, alcohol or medication. A moment of inattention while operating Water jet may result in serious personal injury.
- Use personal protective equipment. Always wear eye protection. Protective equipment such as safety glasses, non-skid safety shoes, waterproof gloves and hearing protection will reduce personal injuries.

- Dress properly. Do not wear loose clothing or jewelry. Keep your hair, clothing and gloves away from moving parts. Loose clothes, jewelry or long hair can be caught in moving parts.
- Be careful removing cut materials from the water jet cutter. Cutting with a water jet cutter creates sharp edges. Improper handling of cut materials may result in cuts and abrasions.
- Do not let familiarity gained from frequent use of water jet cutters allow you to become complacent and ignore water jet cutter safety principles. NEVER expose yourself to the water jet stream. A careless action can cause severe injury within a fraction of a second.

Water jet cutter use and care

- Prevent idle water jet cutters from being used by children and do not allow persons unfamiliar with the water jet cutter or these instructions to operate the water jet cutter. Water jet cutters can be dangerous in the hands of untrained users.
- Maintain water jet cutters. Check for misalignment or binding of moving parts, breakage of parts, water leaks, clogged waste water drains and any other condition that may affect the water jet cutter's operation. If damaged, have the water jet cutter repaired before use. A poorly maintained water jet cutter may result in a risk of shock, fire and/or serious injury.
- Disconnect the plug(s) from the power source and the water supply before performing any maintenance. Such preventive safety measures reduce the risk of starting the water jet cutter accidentally.
- Use the water jet cutter in accordance with these instructions, taking into account the working conditions and the work to be performed. Use of the water jet cutter for operations different from those intended could result in a hazardous situation.

Service

- Have your water jet cutter serviced by a qualified repair person using only identical replacement parts. This will ensure that the safety of the water jet cutter is maintained.

Safety instructions for water jet cutters

- Never expose yourself to the water jet stream since it may cause severe injury and water jet injuries are prone to infection. Proper use and care of this water jet cutter are essential to safe operation. Severe infections can lead to serious medical problems and cause death.
- Do not attempt to modify or defeat the safety interlock system for any reason. This could result in exposure to the water jet stream.
- Never allow the water jet cutter to operate without constant supervision of the cutting process. If the machine malfunctions, immediately follow the manufacturer's instructions for shut down.
- Never operate a water jet cutter without proper drainage for the waste water system. Before use inspect the drainage to ensure proper water flow is not blocked. While in operation water jet cutters create a continuous flow of waste water which can quickly flood surrounding areas if not drained away, flooding may increase the risk of personal injury and electric shock, and may cause water damage to property.
- Never operate a water jet cutter with broken or kinked high-pressure hose lines. Always ensure the positioning of the hose line is unlikely to cause people to trip, or the kink, loop and tensile force to be excessive during operation

- Never cut any unknown or toxic materials and properly dispose of waste products. Always refer to the Safety Data Sheet (SDS) from the material manufacturer to determine if it is safe to return water contaminated by cut material to the water system. Follow local regulations to properly dispose of all waste products including water, spent abrasive and cut material debris.
- Keep the interior of the water jet cutter, clean and free of debris. Clean the cutting head and abrasive supply hose. A build-up of cutting and engraving residue and debris is dangerous and may increase the risk of improper performance or an environmental hazard such as clogging, overflowing, and jamming.

WAZER Safety Precautions

▲WARNING In addition to the “General Power Tool Safety Warnings” in the previous section we have outlined a set of WAZER specific safety precautions. In general, this entire User Manual is filled with important safety information – please read it carefully and ensure that anyone that uses WAZER has read this User Manual as well. Before setting up and using WAZER, read and follow all instructions and safety messages. ALWAYS be aware of and comply with all federal, state, and local safety regulations, industry standards, and internal company safety guidelines.

Environment and Machine Location

- WAZER operators should ensure anyone within 10 feet of the WAZER follows the proper safety precautions.
- WAZER should be installed in an area that allows the machine to be monitored while cutting.

Usage

- WAZER can cause serious injury and should be accessible only to those that have read this User Manual and are capable of understanding the risks associated with this tool. Ensure the WAZER location will never result in an untrained individual using the machine.
- If WAZER is intended to be used by multiple people, put an orientation and training program in place at the facility to ensure correct usage.
- Do not setup, operate, or perform maintenance on the machine under the influence of illicit drugs, alcohol, or over-the-counter and prescription drugs that can impair one's ability to operate heavy machinery safely.
- All operators of WAZER must be aware of the Power Switch, On/Off Valve, and water shutoff locations.
- Do not use WAZER or its components in any manner or for any other purpose other than as specifically instructed in this User Manual.
- Do not modify WAZER or its components.
- Never leave WAZER unattended while in operation.
- All operators of WAZER must follow the safety precautions outlined in the Safety Data Sheet of WAZER approved Abrasive.
- Use of non-WAZER approved Abrasive can result in equipment or property damage as well as personal injury.
- All operators must follow the safety precautions outlined in the Safety Data Sheets for the materials cut on WAZER.
- Always follow the correct startup, operating, and shutdown procedures outlined in this User Manual.

Setup

- Always use proper lifting techniques when lifting heavy components to avoid injury or strain.
- Always make sure the machine is secured using the Wall Mount Bracket.
- Ensure WAZER is plugged into a properly grounded pronged receptacle. Refer to a licensed and qualified electrician and your local national, state, and local codes if you have any questions. Never modify the plug.
- Ensure the Pump Box is plugged into a properly grounded three pronged receptacle that exceeds breaker requirements. Refer to a licensed and qualified electrician and your local national, state, and local codes if you have any questions.
- Only operate WAZER and Pump Box on designated power supply. This may be 110V/60Hz or 220v/50Hz depending on which model you purchased. Never attempt to operate it using converters or adapters. Always keep your work area clean.

Operation

- Never operate WAZER with components out of place or missing. This includes and is not limited to the Cut Bed, Nozzle Cover, Nozzle, and Door.
- Never override any safety sensors or systems in WAZER.
- Never touch components inside the Enclosure if WAZER is operating. This includes, but is not limited to, the Cut Bed, Nozzle, and the Material you are cutting.
- Stay clear of all high-pressure components during operation.
- Never reach under, over, or into WAZER or Pump Box during operation.
- Never place hands under the Cutting Head of the machine. This includes while the machine is in the turned off state.
- Risk of injury due to accidental starting, keep children away from WAZER while it is running
- Never leave the machine unattended in the paused or any state of being on. If you must leave the vicinity of the machine be sure to perform the appropriate shutdown procedure for your machine prior to leaving the area.

Shutdown

- Always disconnect WAZER from power and shut off the water supply when leaving WAZER unattended.

Maintenance

- Follow all maintenance procedures and schedules presented in the User Manual. Failure to maintain WAZER could result in damage to WAZER or the Pump Box, a degradation of cut quality, or create safety risks to you and your environment.
- Do not engage in any maintenance while WAZER is connected to power and water supply. Always disconnect WAZER from all power sources and water sources before opening the Pump Box or interacting with any electronics.
- Do not perform unauthorized maintenance on WAZER or its components. All maintenance must follow instructions in authorized sources of information including this User Manual, WAZER resources site, and content provided by WAZER Customer Support.

Leaks

- Before and after a Cut, always inspect the surrounding area of WAZER and Pump Box for leaks.
- In the event that a leak is observed, turn off the power going to WAZER, wipe it down, and **LET IT DRY OVERNIGHT** before seeing if anything was damaged and is still working. Water doesn't damage electronics, it's the combination of water with running electricity that does; so letting them air dry ensures that the next turn on won't destroy something.
- Never attempt to identify the location of a leak when the machine is on.

Disassembly and Decommission:

- Never discard WAZER in the trash. WAZER is a tool that contains electric and electronic components, proper disposal is required.
- Never skip steps when decommissioning WAZER. Follow every step to safely decommission WAZER.
- Never prepare WAZER for shipping with unapproved packaging or shipping method. Always connect with WAZER customer service before shipping WAZER.
- Always abide to national/federal/local law and regulation for process of decommissioning WAZER.

Injuries

Injuries caused by high-pressure waterjets can be serious. In the event of any waterjet injury the Waterjet Technology Association recommends:

- Seek medical attention immediately. Do NOT delay!
- Inform the doctor of the injury.
- Tell the physician what type of waterjet project was being performed at the time of the accident and the source of the water and the materials involved.

Inform the physician of the following information:

- This patient may be suffering from a waterjet injury.
- Evaluation and management should parallel that of a gunshot injury.
- The external manifestations of the injury cannot be used to predict the extent of internal damage.
- Initial management should include stabilization and a thorough neurovascular examination.
- X-Rays can be used to assess subcutaneous air and foreign bodies distant from the site of injury.
- Injuries to the extremities can involve extensive nerve, muscle, vessel damage, as well as cause a distal compartment syndrome.
- Injuries to the torso can involve internal organ damage. Surgical consultation should be obtained.
- Aggressive irrigation and debridement is recommended.
- Surgical decompression and exploration may also be necessary.
- Angiographic studies are recommended pre-operatively if arterial injury is suspected.
- Bandages with a hygroscopic solution (MgSO₄) and hyperbaric oxygen treatment have been used as adjunctive therapy to decrease pain, edema, and subcutaneous emphysema.
- Unusual infections with uncommon organisms in immunodeficient patients have been seen; the source of the water is important in deciding on initial, empiric antibiotic treatment, and broad-spectrum intravenous antibiotics should be administered.
- Cultures should be obtained.

For your convenience, we have also included a set of wallet sized laminated medical alert cards at the front of this printed user manual. This card contains the above injury treatment information per the Waterjet Technology Association's recommendation. We recommend users of the machine to carry this card.. Additional copies of this card can be attained by contacting WAZER Customer Support.

CAUTION Bacteria can build up in the standing water of the Tank. Any injuries or cuts, even minor ones, should be treated with caution. If you have open wounds avoid contact with the water or wear gloves that do not expose you to the Tank water.

WAZER

A basic understanding of WAZER's work flow and design will make it easier to follow the rest of this User Manual.

WAZER is an entirely new waterjet cutting system; please review this section even if you are familiar with other waterjet systems.

- WAZER Work flow
- Main Components
- How it Works
- Systems Dissection
- Specifications

WAZER Workflow

Here are the basic steps for cutting on WAZER:

1. **Design a part to cut on WAZER.** Once the Design is complete, export a .dxf or .svg file of the 2D part (or multiple parts to be cut from a single sheet)
2. **Import the file(s) into Wam (WAZER's software).** Now you will prepare to cut your part in a Material; you'll specify the Material, thickness, and desired Cut Quality.
3. **Use Wam to turn your Design into instructions that WAZER understands.** Just transfer this Cut File onto an SD Card and plug it into WAZER. You'll use the Control Panel on WAZER to select this file for cutting.

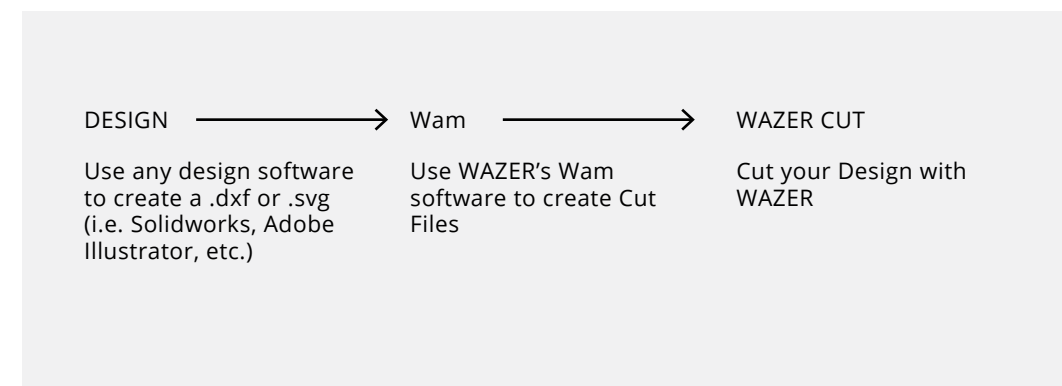

WAZER Components

WAZER has two main components:

- **The Main Unit**, which contains the Cut Bed and Control Panel.
- **The Pump Box**, which pressurizes water and provides the energy for cutting.

Once initial setup is performed, the user will primarily interact with the Main Unit to cut Materials and perform basic maintenance related tasks. The two components are connected to one another via a High-Pressure Hose and a Signal Cable.

How it works

WAZER combines high-pressure waterjet technology with several electro-mechanical systems to bring you an all-in-one cutting solution.

The Pump Box pressurizes water that is then routed to Main Unit and expelled through a small orifice, where it accelerates to a very high velocity. At this point the WAZER introduces Abrasive to the Jet to create a slurry of water and abrasive. This high-pressure stream of abrasive slurry performs the cutting in a waterjet system. By controlling where this stream is ejected, WAZER allows you to cut your design with digital precision.

A Tank below the cut bed catches the slurry after it does its cutting work. A collection system allows WAZER to separate the slurry back into water and Used Abrasive. The water is expelled out of WAZER, while the used abrasive is separately collected inside of the machine for later removal.

An on-board Control Box runs the logic behind WAZER. This Control Box is connected to all the input and output components of WAZER, allowing the machine to operate all the individual systems in harmony. Additionally, it allows the user to interact with WAZER through an on board Control Panel.

The nature of the water jet stream allows for very accurate cutting in thinner materials and the kerf shape is still acceptable for most users up to ½" thickness. Beyond that the WAZER may still be capable of cutting the material but it is important to remember that cut accuracy will diminish as the material thickness is increased (even at "fine" cut qualities). Given the fact water is involved, absorbent material such as wood, paper or dry wall are not recommended to be cut in WAZER. Moreover, attempts to engrave or surface etching material with WAZER will result in damage of machine, this is strictly prohibited.



WAZER MAIN UNIT FRONT

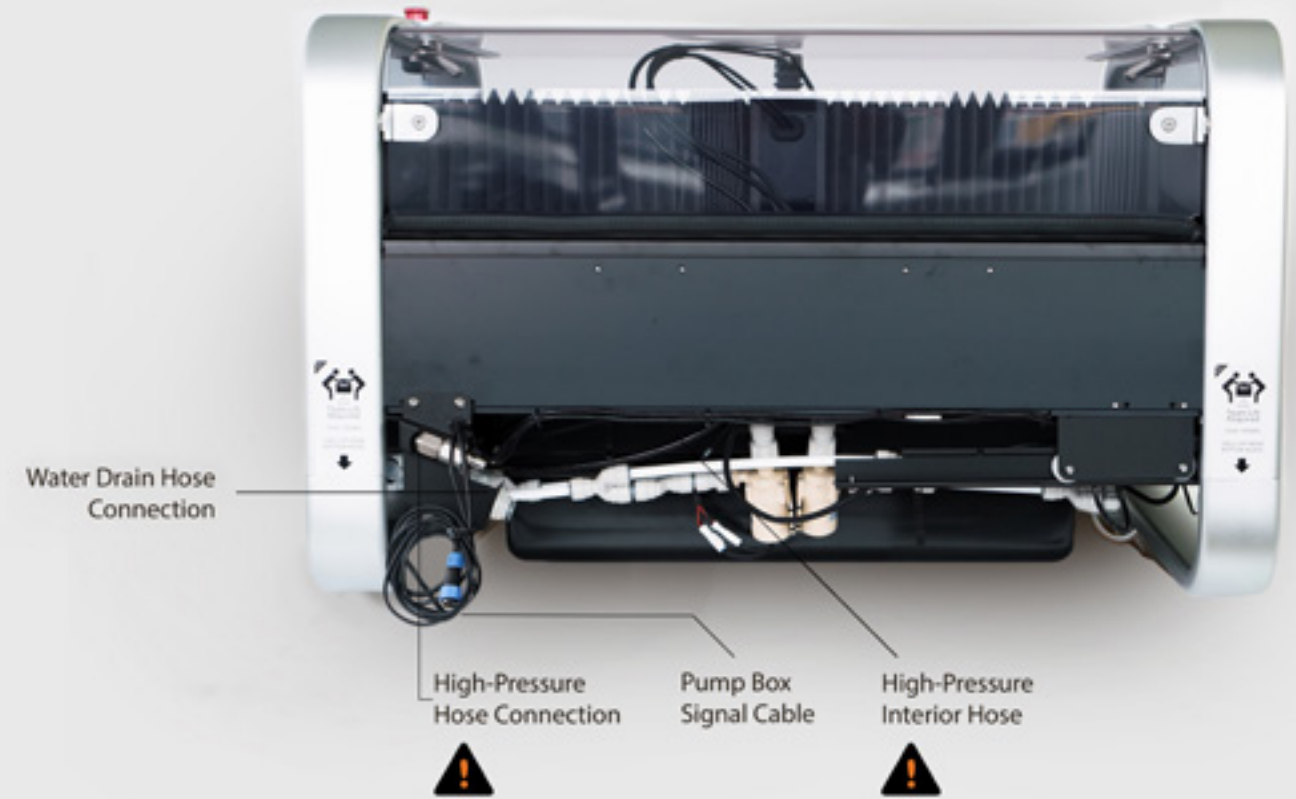

WAZER MAIN UNIT BACK

WAZER Systems Dissection

WAZER can be broken into seven systems based on the primary functions they serve:

1. **⚠ High-Pressure** – This system pressurizes water for cutting, mixes the water and abrasive, and ejects the mixture toward the material. Stay clear of all high-pressure components during operation. They are clearly identified on the illustrations in the following pages. All operators are required to be familiar with these components and their location.
2. **Abrasive System** – This system stores the abrasive and controls its flow to the high velocity Jet.
3. **Enclosure** – This contains the water, Used Abrasive, and Material you are cutting within WAZER.
4. **Filtration** – This system separates tank water and used abrasive, collects the used abrasive from the tank and drains water out of WAZER.
5. **Gantry** – This system controls the motion of the Nozzle.
6. **Control Box** – This includes the electrical components that control and distribute signals throughout WAZER.
7. **Cut Bed** – This is where you fasten your material.

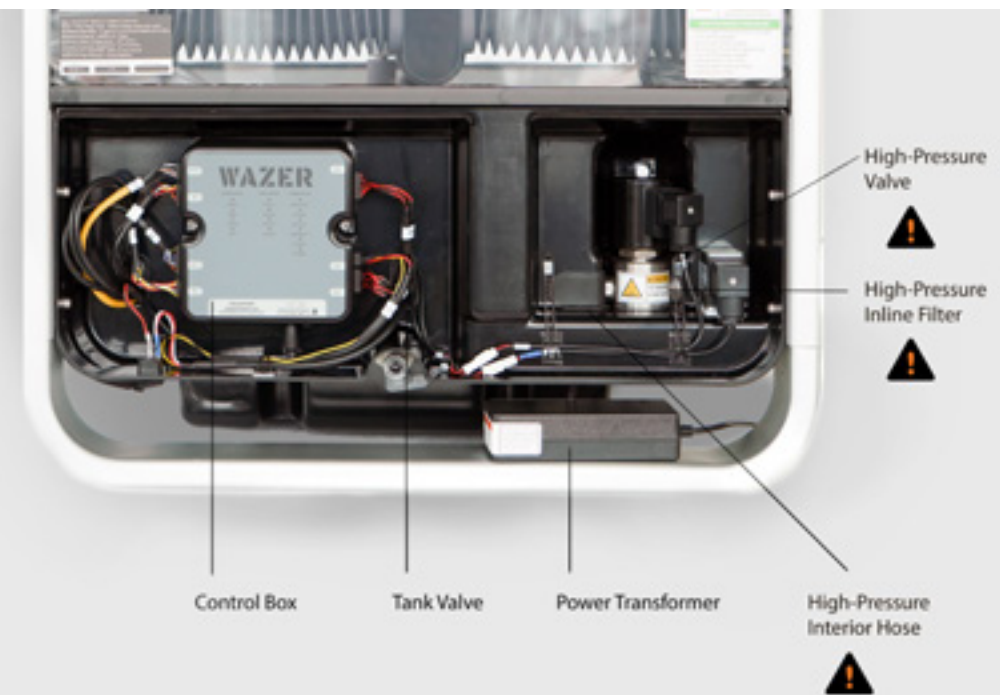

WAZER MAIN UNIT RIGHT SIDE PANEL

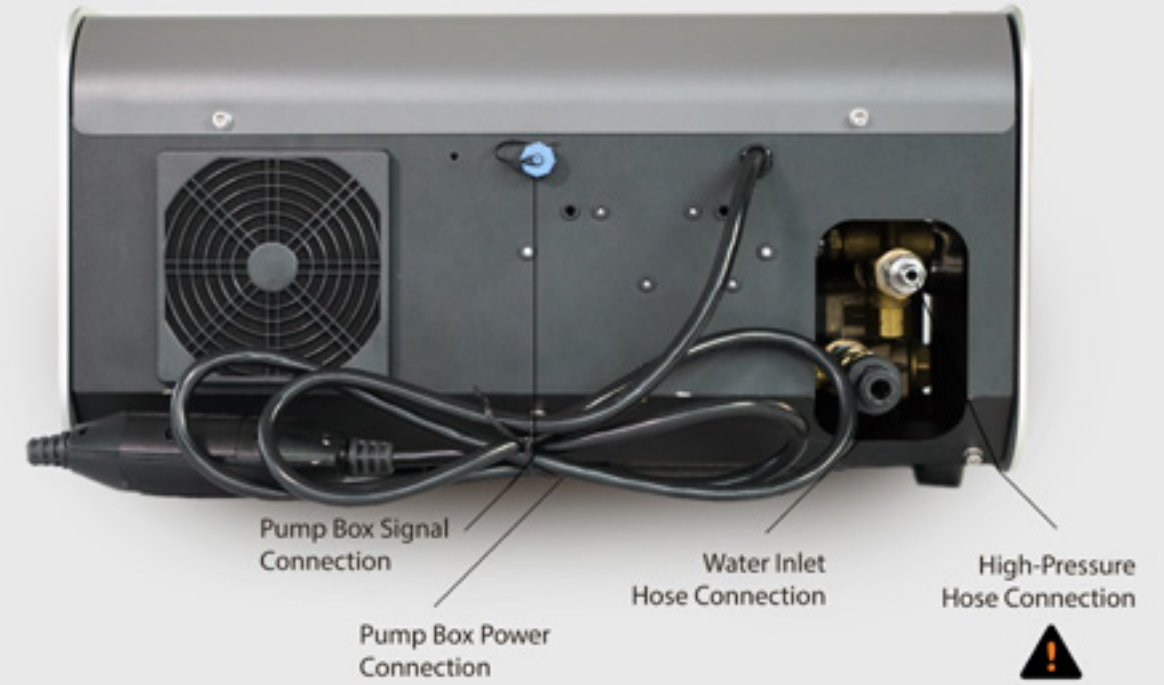
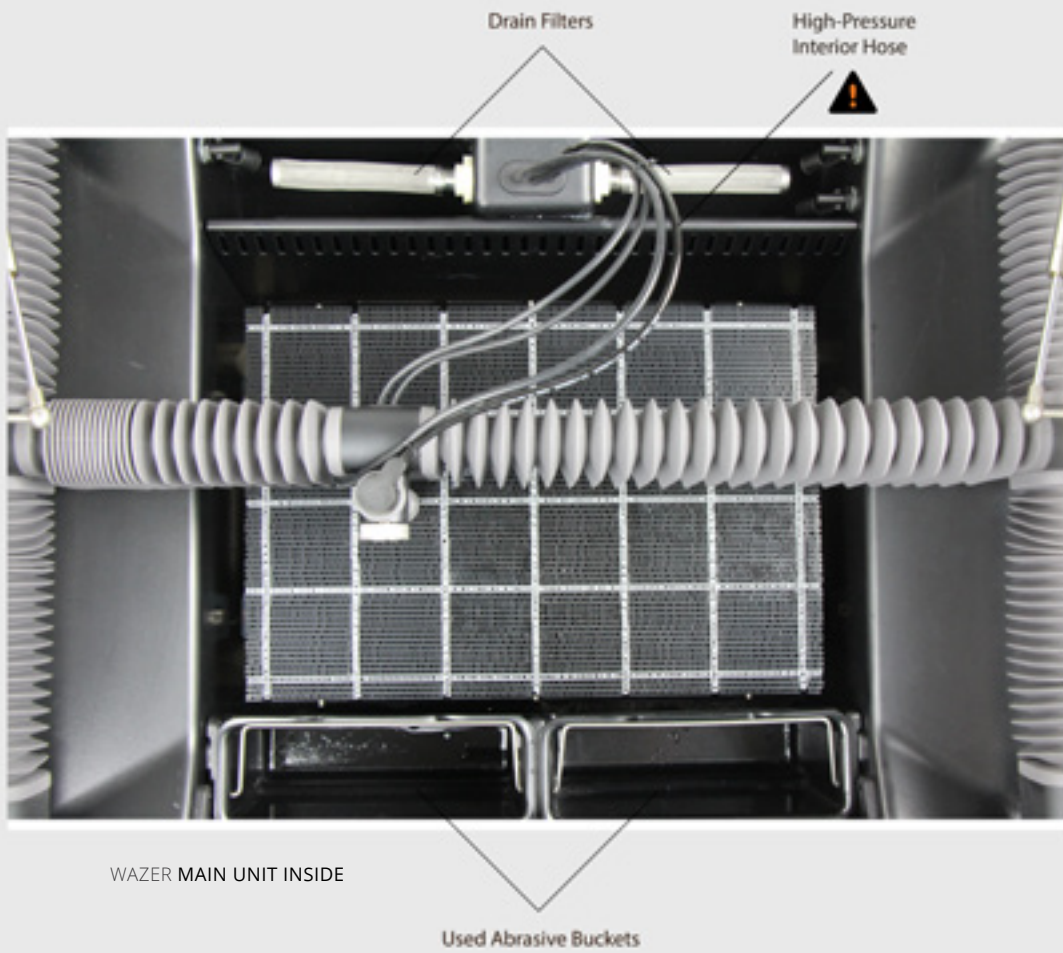
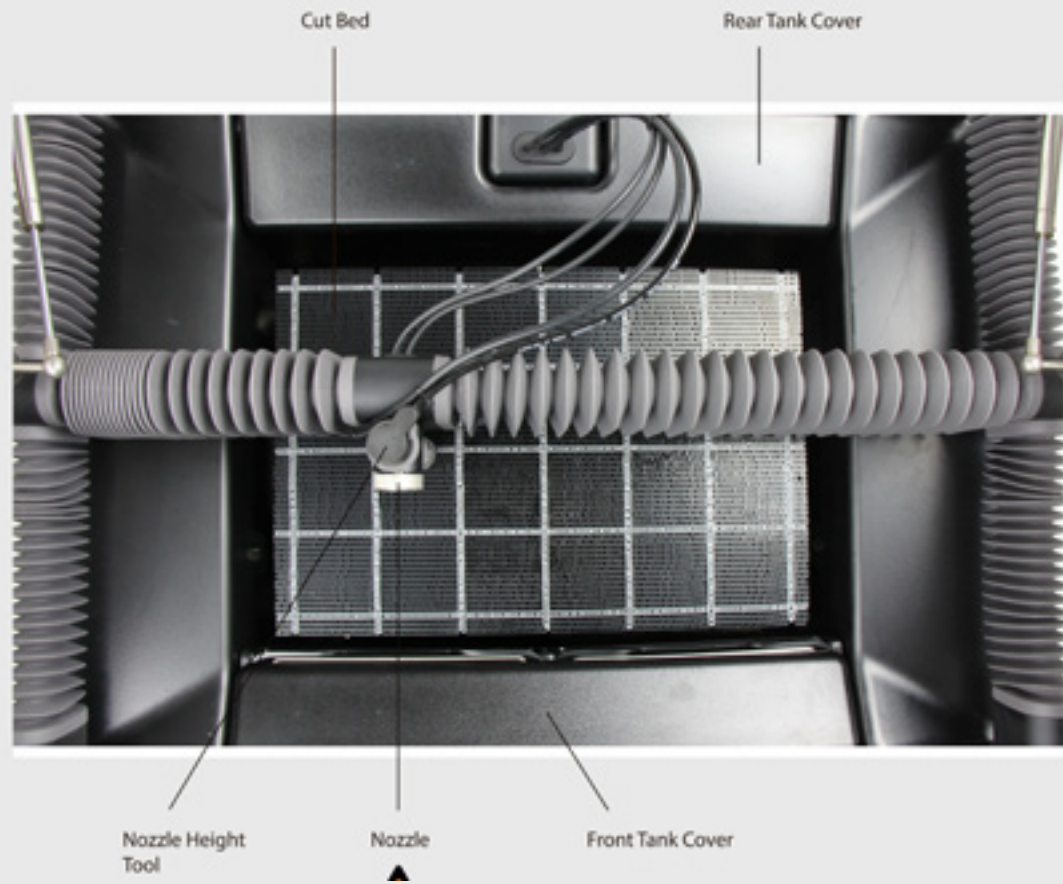

PUMP BOX - BACK

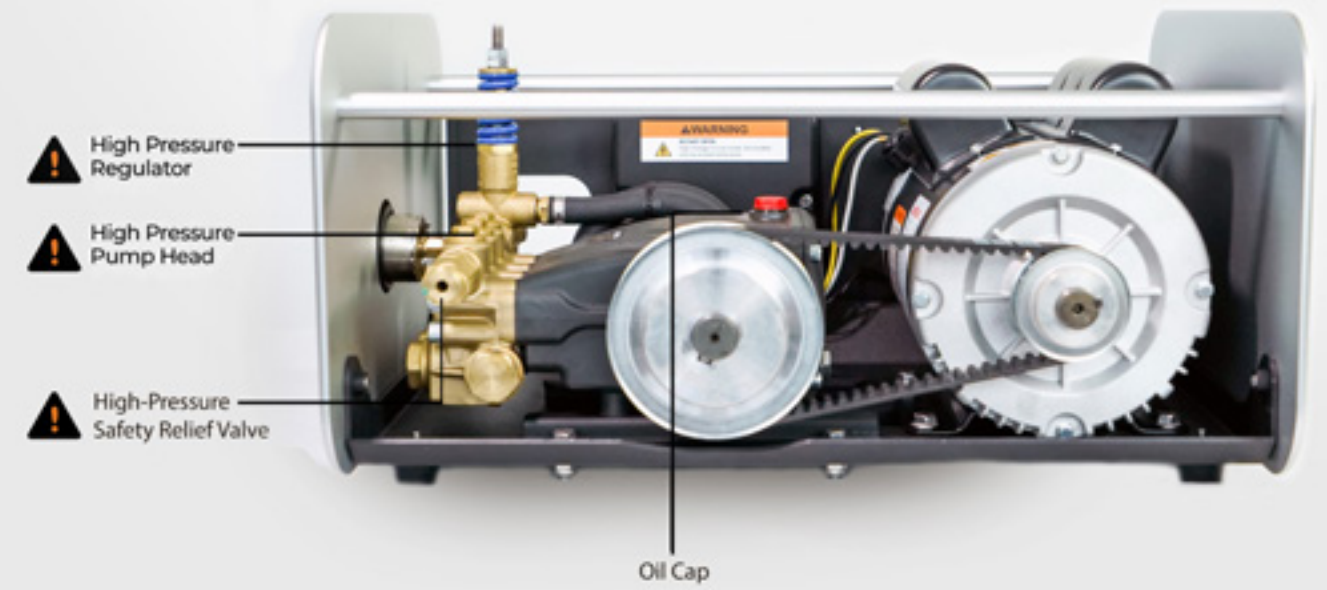

PUMP BOX - INSIDE

WAZER Specifications

Size and Weight

WAZER Main Unit Size	34" x 25.5" x 22" (856mm x 648mm x 551mm)
WAZER Main Unit Size with Stand Leg Accessory	34" x 25.5" x 48" (856mm x 648mm x 1220mm)
WAZER Main Unit Empty Weight	110 lbs. (50 kg)
WAZER Main Unit Loaded Weight	400 lbs. (180 kg)
Pump Box Size	21" x 15" x 11" (533 mm x 355 mm x 280 mm)
Pump Box Weight	92 lbs. (42 kg.)

Cutting

Cutting Area	12" x 18" (305 mm x 460 mm)
Cut Bed Size	13" x 19" (330 mm x 485 mm)
Kerf (width of cut)	.044 (1.2 mm)

Water

Water Source	Tap Water
Water Draining	Standard Water Drainage
Input Water Filter	~300 mesh
Water Recirculation	Not Recommended

Abrasive

Abrasive Flow Rate	0.33lbs/min (150g/min)
Abrasive Capacity	30 lbs. (13.5 kg.)
Abrasive Type	Garnet 80 mesh

Gantry

Maximum Linear Speed	75 IPM (1905 mm/min)
Gantry Positional Precision	0.003" (0.08 mm)

Power

Main Unit V1.5 (110 VAC and 220 VAC)	110-240 VAC, 50/60Hz, 2.0A,
Pump Box V1.5A	110-120 VAC; 60Hz; 15A; 1700 W
Pump Box V1.5B	220-240 VAC; 50Hz; 10A; 2200 W

Wam Software

Browser Compatibility	Chrome, Internet Explorer, Safari, Firefox
-----------------------	--

Miscellaneous

Compatible File Types	.dxf, .svg
Connectivity	SD Card

Noise Emission	74+/- 3dB
Noise Pressure Level	87+/-3dB
Storage Condition	0°C - 40°C / 32°F-104°F for prolonged storage 0°C - 70°C / 32°F-160°F for 24 hours
Maximum Working Pressure & Flow Rate	4600psi (32MPa) at 0.5 gal/min (1.9L/min)

Machine System Schematics

Your WAZER system contains 100s of components that interface with one another. Even though it is unnecessary for you to be familiar with all of them, it is a good idea to familiarize yourself with a system level view of your machine. In order to do so we have created a few system level schematics and diagrams. Review these, but don't worry about memorizing and understanding them fully at this stage. After you work through your first set of cuts we highly recommend coming back to these diagrams to connect the dots between the components and systems behind the work flow you experience with every cut. Lastly, if you are trying to troubleshoot an issue, the system level breakdowns here could help in pinpointing what could be the issue.

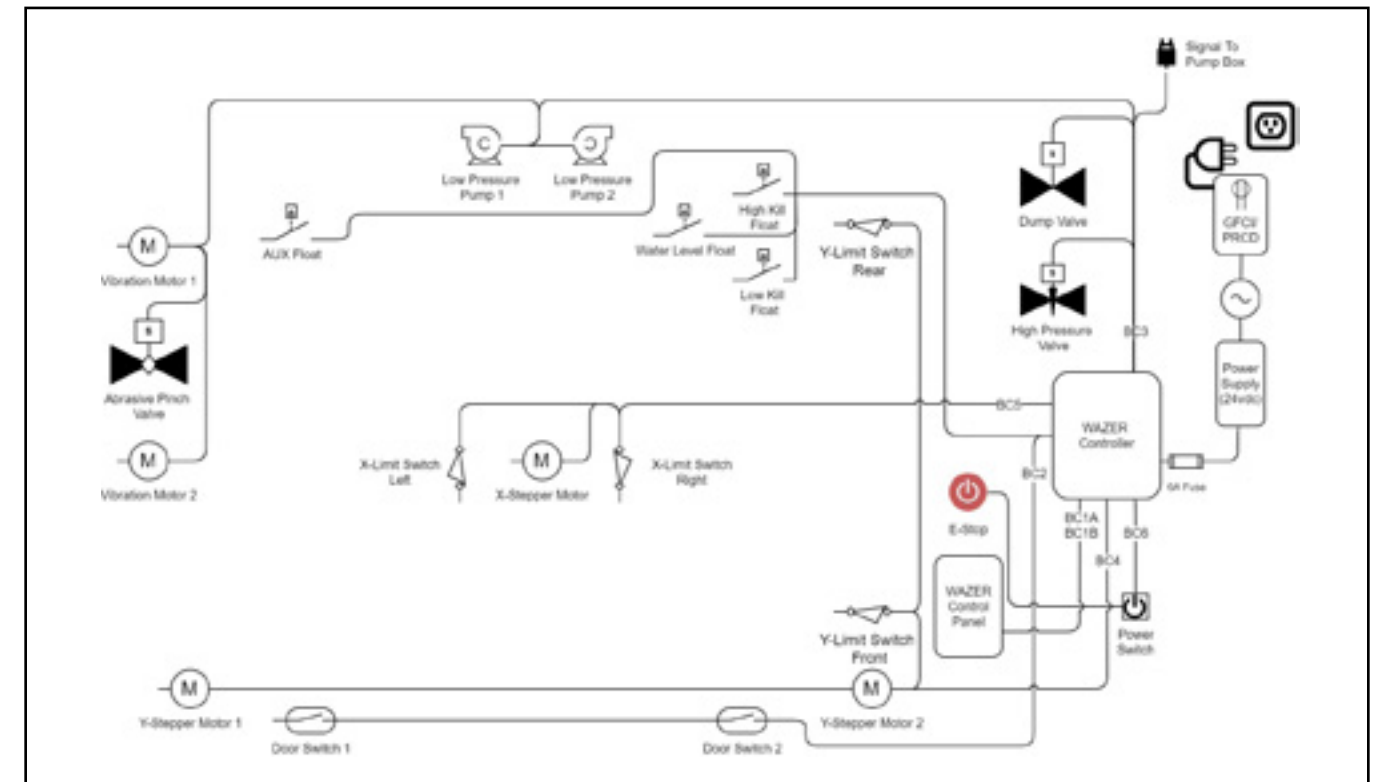

Main Unit Control System Diagram

The above illustration shows the high level system schematic of the WAZER Main Unit's electro-mechanical components and controls system.

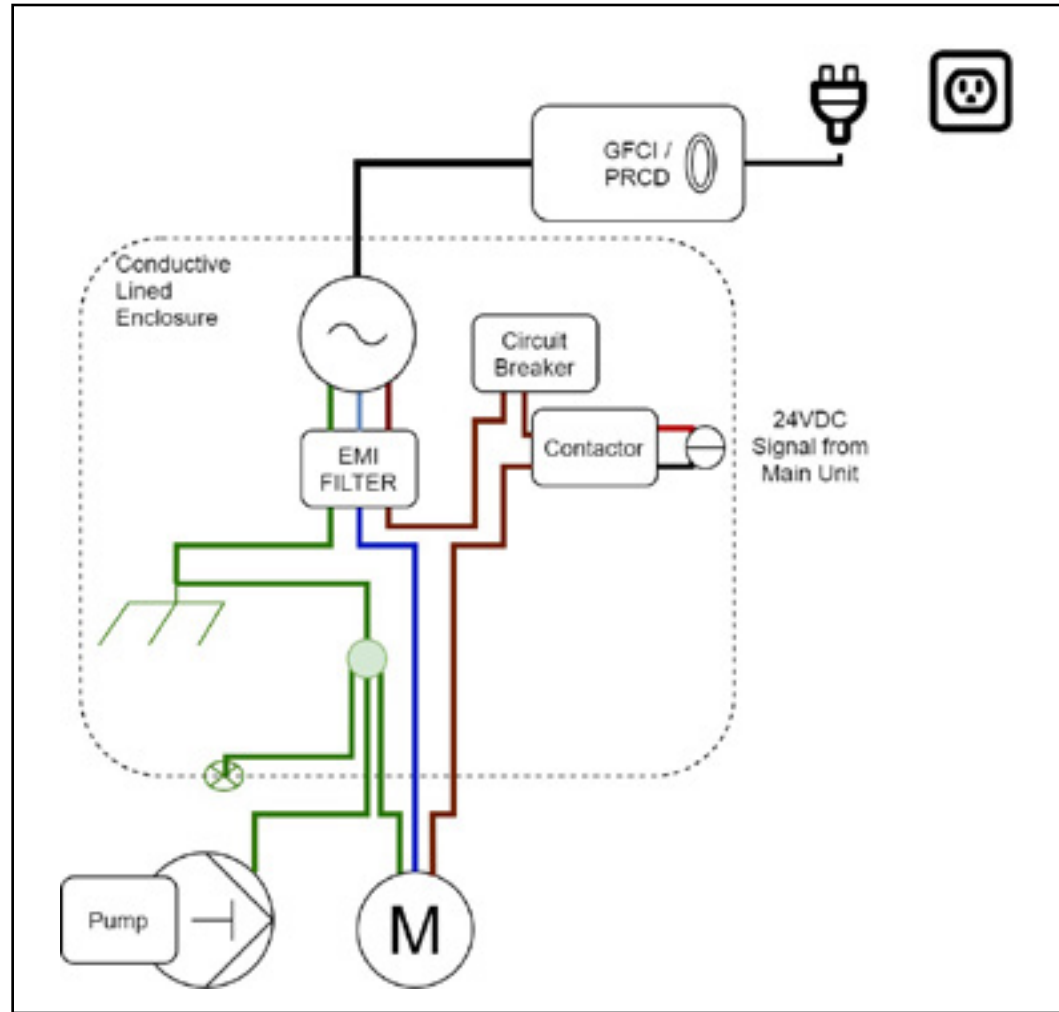

Pump Box Electronics Layout Diagram

The above illustration shows the high level system schematic of the Pump Box wiring and electro-mechanical components.

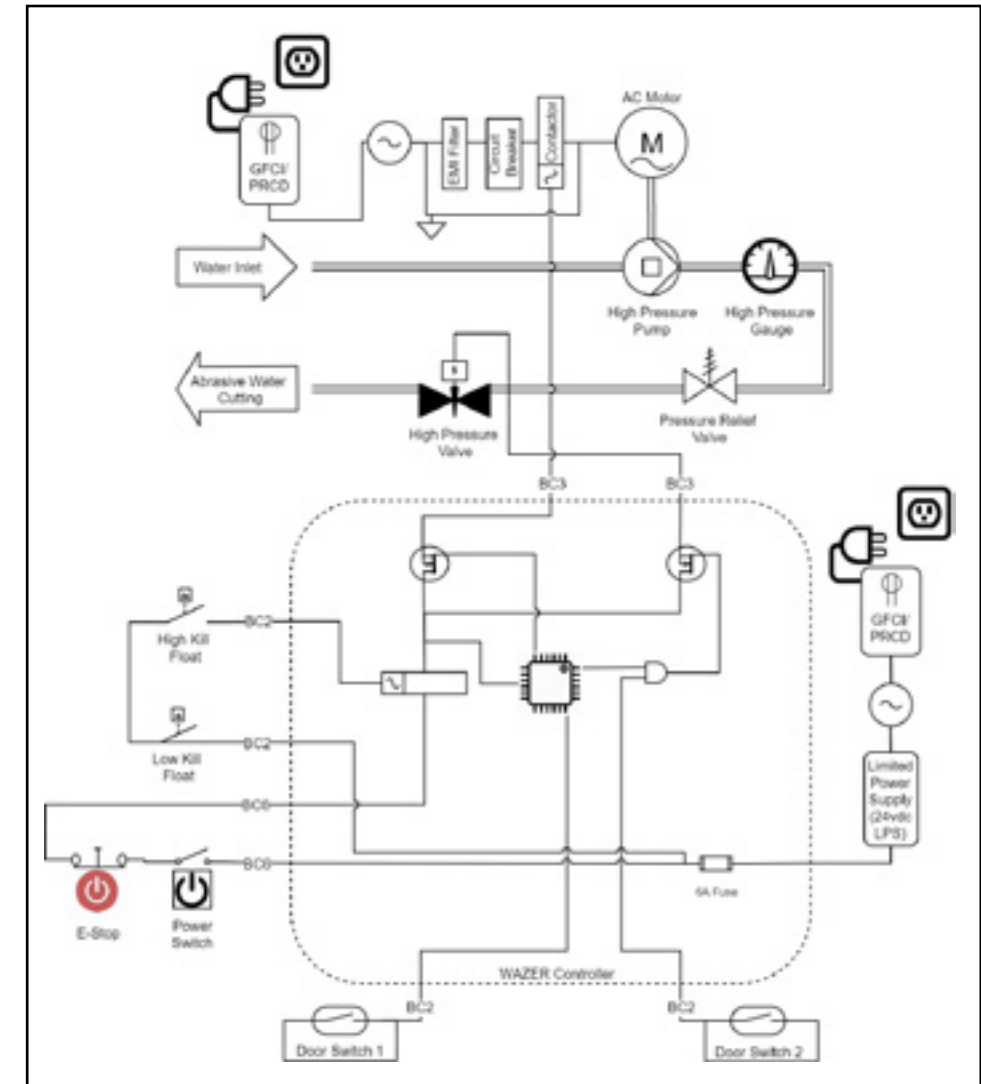

Safety Function Diagram

The above illustration shows a system level diagram of the safety functions that are incorporated in your WAZER. These include electrical shock protection, protection from contact with the high pressure water stream, and correct water management to protect your environment.

Setting Up WAZER

Install WAZER.

In this section, we will discuss preparing the WAZER's location, unboxing it properly, completing the physical installation, and connecting WAZER to electricity and water. After you complete this section, you will be ready to make your first Cut.

The following procedures must be followed to setup WAZER:

- Choose a location for WAZER
- Unbox WAZER
- Install WAZER
 - Install the Pump Vent Cap
 - Establish three water connections
 - Establish three Power Cable connections
 - Anchor WAZER to the wall

Most of these tasks have multiple steps. It is crucially important to get the installation right, or WAZER will not function properly. Read carefully and don't hesitate to get in touch with WAZER support if you are still unclear after reviewing the User Manual.



VIDEO icon indicates that video instructions are available. To see our How-To Videos, visit www.wazer.com/resources.

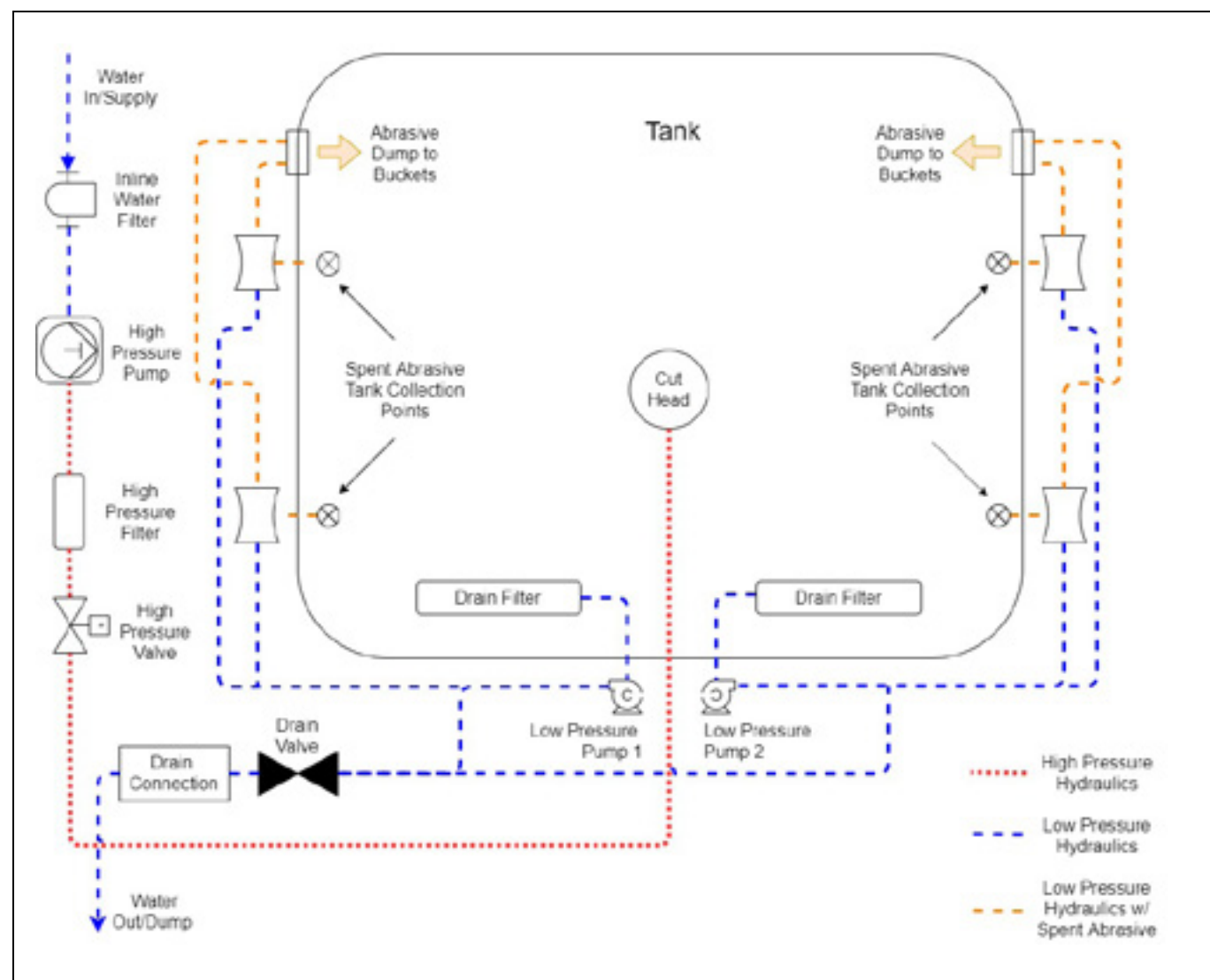

Hydraulic System Diagram

The above illustration shows the high pressure and low pressure hydraulic system diagrams with relevant components.

Choosing a Location for WAZER

Location Requirements

Ensure that your installation location meets ALL the following requirements:

Electrical:

The WAZER Main Unit only comes as one model and can be plugged into 110-220VAC power. However, the Pump Unit comes as different models for the specific voltage region they are intended for. This setup guide is for both the 110 VAC 60hz WAZER (pump unit designated as V1.5A) and the 220 VAC 50hz WAZER (pump unit designated as V1.5B). Please ensure you follow the appropriate electrical hookup instructions below given your model of WAZER. You can verify your model by looking at the serial number tags on your Pump Unit.

- 110 VAC 60hz (V1.5A): This version of WAZER has its Main Unit consume up to 2amps and its Pump Unit consume up to 15 amps. Given traditional 110 VAC 60hz household and shop circuits you will be required to have one of the following for your machine:
 - 2x 15amp circuits (common household shop application)
 - 1x 20amp circuit (common industrial and shop application)
- 220 VAC 50hz (V1.5B): This version of WAZER has its Main Unit consume up to 1 amp and its Pump Unit consume up to 10 amps. Any circuit >11amps will be sufficient.
- As is usually the case with high load motors, there is an inherent “in-rush current” that will momentarily exceed the stated steady-state run currents above for a fraction of a second. The time associated with this “in-rush current” is very short and almost all household and commercial AC breakers are designed to handle this safely without tripping. However, in the rare case that you run into trouble with your breaker tripping you may need to consult an electrician to have your system checked to handle on the order of 60amps for 150 milliseconds.

Water Supply:

NOTICE Some areas are susceptible to dirty water or water main breaks. Please be sure to include a mechanical prefilter before the inlet to the pump to ensure water supply contaminants don't go into the pump. We cannot be held accountable for damage caused to pump as a result of contaminated water supply.

- **Flow Rate: Greater than 1gpm (3.8L/min).** Most household and commercial water plumbing will meet this requirement. Typical bathroom faucets 1-3 gpm, kitchen faucets 2-4 gpm, and outdoor/shop hoses 3-6 gpm.
- **Pressure: 35-125psi (0.24MPa – 0.8MPa).** Most household and commercial water plumbing systems fall in this range. The higher in that range, the better for the Pump Box in terms of its longevity.

- **Temperature: 130°F (54°C).** DO NOT use a hot water line for WAZER.
- **Water Hardness: Less than 180 mg/L (10.5 gpg).** Water hardness is the biggest factor that affects the longevity of the components. Most municipal water in North America is below this figure, however we suggest you give your region a search if this is a concern.
- WAZER should not be used in noisy electromagnetic environments. Some appropriate environments include laboratories, household workshops, and most machine shops. Heavy industrial environments that contain machinery or devices that induce electromagnetic interference on other adjacent devices (either on the same circuit or in the general proximity) should be avoided.

Water Drainage:

Make sure that it does not take more than 30 feet (9m) of your Water Drain Hose to go from WAZER to the drain. Additionally, the drain location should be less than 4 feet (12mm) above WAZER.

Desktop:

- Sturdy and capable of holding over 400 lbs. (160kg)
- Flat and level under load. The levelness is key for correct operation of WAZER. Maximum 1.5mm of height difference across entire Cut Bed
- A clear area of 46" by 27" (1.2m by 0.7m) to allow for access.
- Does not deteriorate when exposed to water. Because under some unforeseen scenarios, water may stream out from abrasive hopper and other places.
 - Good choices: quartz, stainless steel, treated solid wood
 - Poor choices: plywood, unfinished MDF or particle board
- NOTE: No desktop is necessary if you plan on using WAZER with the Stand Leg Accessory. However, please keep a 62" area above the floor footprint that you intend to place your WAZER on in order to allow access to it.
- **Floorspace:** The Pump Box is intended to be placed on the floor and requires 30" x 26" (0.8m x 0.7m) of space to allow for adequate airflow, cables, and hoses.

Ambient Air Temperature: 40 - 100 F / 5 - 40 C
WAZER should never be operated outside of this range.

Space Around WAZER: Make sure to leave at least 12" (0.4m) of free space on the right and left sides of WAZER. On the left side of WAZER, you will need room to refill the Abrasive Hopper. On the right side, you may need access to the Control Panel.

Wet Area:

WAZER operates with abrasive and water. Though WAZER is enclosed, it is not a sealed system, and water and abrasive will inevitably leak on occasion. The floor surface should be water-resistant, slip proof and smooth enough for easy cleanup of spills. A nearby floor drain is also recommended. Water may stream out from under your abrasive hopper as an example of why this machine needs to be in a water tolerant area.

Proximity to Abrasive Storage:

Abrasive is heavy. If you will be cutting often make sure that the WAZER location is close to a storage area for Abrasive and Used Abrasive. Moving abrasive long distances can quickly become cumbersome.

Noise:

WAZER emits noise that would be disruptive in settings such as classrooms and offices. Make sure to place WAZER in a location where the noise level of traditional shop tools like drills and saws is acceptable.



Unpacking

Estimated Time: 30 minutes
Requires two people

WAZER arrives in a Crate. Within this crate you will find a variety of other boxes. These boxes will contain all the components needed to run WAZER.



⚠ CAUTION

Before attempting to uncrate WAZER, please be sure to have:

- Two people capable of lifting 60lbs (27kg) each
- Box cutter or scissor
- Cart or dolly
- Adjustable wrench
- Large bucket



RECOMMENDED: If you have a cart or dolly it is highly suggested you use it to move the individual boxes.

Uncrating

Please follow these instructions to properly uncrate your WAZER:

1. Inspect your Crate and take pictures of any damage to the exterior.
2. Cut the straps that wrap the Crate and remove the top to the box.
3. Take the crate quarter panel out, and then tri-fold panel.



4. **WAZER Stand Leg Accessory (if included):** Remove the WAZER Stand Leg Accessory box.
5. **Abrasive (if included):** Remove the Abrasive buckets.
6. **Pump Box (Two-person lift):**  With one person on each side of the box, firmly grip the underside of the box or packing straps, then orient the Pump Box right side up and place it near the intended location of WAZER.
7. **WAZER (Two-person lift):**  With one person on each side of the box, firmly grip the underside of the box or its packing straps, then place the WAZER box near the intended location of WAZER.
 - a. **Be sure to observe proper orientation of this box. Never place it on its sides or invert it.**
 - b. Do not place the WAZER box on any surface that cannot bear significant weight.

Moving the WAZER box through some environments (i.e. tight corners, narrow doors) may not be possible. In this case, skip to WAZER Unboxing. Note that you will need to take extra care not to damage WAZER when moving the machine to its final location.



Unboxing WAZER

Please follow these instructions to properly unbox your WAZER:

1. **DO NOT** tilt or flip the WAZER box. This step requires a two-person lift. Do not attempt to tilt the unit onto a dolly.
2. Cut the straps that wrap the box and cut the tape on the top of the box to unfold its flaps. **DO NOT** make a deep cut into the box, as you will scratch the unit.
3. Cut through the cardboard from top to bottom at each corner of the box.
4. Remove the packaging that surrounds WAZER.
5. There are Accessories packed around and under WAZER; remove these and put them in a safe place before lifting WAZER. Note that there may be some residual water in the bag from the testing process.
6. Carefully open the bag that WAZER is wrapped in.
7. Inspect the exterior for any damage. Note that you may see some water or even some Used Abrasive inside the cutting area; this is from quality assurance testing.
8. If you have purchased the Stand Leg Accessory, switch to those instructions at this point. These instructions are included in the Stand Leg Accessory box. If you intend to set up WAZER on a table or desktop then continue reading here.
9. By now, you should have selected an appropriate location for WAZER. If not, review the **Location Requirements** section of this chapter before proceeding. Improper placement of WAZER may result in poor performance, property damage, or injury.
10. **(Two Person Lift)** With one person on each side of the unit, firmly grab the bottom of the two aluminum hoops and move WAZER onto its desktop.
11. **Positioning for setup:** You will need access all around WAZER in order to make the necessary connections. Do not put WAZER up against a wall at this point.



NOTICE ONLY lift WAZER from the bottom of the silver aluminum hoop-shaped legs. We recommend you to retain the packaging for return and decommissioning, if required.



Unboxing the Pump Box

Please follow these instructions to properly unbox the Pump Box:

1. Cut the straps that wrap the box and cut the tape on the top of the box to unfold its flaps.
NOTICE DO NOT make a deep cut into the box as you will scratch the Pump Box.
2. Remove the surrounding packaging.
3. **(Two-person lift)** With one person on each side, grab the bottom of the two aluminum side plates, lift the Pump Box and place it near its final location. Be careful not to allow your fingers to be pinched as you set the it down.
4. Carefully open and remove the unit from the bag that it is wrapped in. There may be some residual water from the testing process.
5. Leave access to the Pump Box's rear connections. **We strongly recommend placing the unit on the ground directly underneath or near WAZER.** Make sure it is easy to see the Pump Box so that you can easily detect leaks.
6. Inspect the unit exterior for any damage. This includes scratches, dents or cracks to the exterior of the WAZER pump box.



NOTICE ONLY lift the Pump Box using the bottom of the silver plates on the left and right sides. We recommend you to retain the packaging for return and decommissioning, if required.



Verify Your Shipment's Contents

In an effort to improve your WAZER experience, there may be additional items that we include with your shipment. It is likely they are included to aid in the setup, maintenance, or operation of your WAZER.

- 1x - User Manual
- 1x - WAZER Main Unit
- 1x - Pump Box
- 1x - WAZER Power Cable (GFCI/PRCD)
- 1x - Water Filter Kit



Setup Kit

- 1x - SD Card
- 1x - Pump Vent Cap
- 1x - 17mm Wrench
- 2x - Water Sensor
- 1x - Wall Anchor Kit
 - 1x - Wall Mount Bracket
 - 3x - Sheet Rock Anchor
 - 3x - Sheet Rock Fastener
 - 3x - Concrete Wall Anchor
 - 2x - M5x10 Hex Screws
 - 1x - 4 mm Allen Key



Plumbing Kit

- 1x - Garden Hose Adapter
- 1x - Sink Adapter
- 1x - Sink Drain Adapter Kit
- 1x - On/Off Valve
- 8x - #3 Hose Routing Anchors
- 8x - #4 Hose Routing Anchors
- 10x - 6" Zip-Ties



Spare Parts and Toolkit

- 2x - Fuse
- 1x - Nozzle Height Tool
- 1x - Nozzle Cover
- 1x - Abrasive Hose
- 2x - Abrasive Hose End
- 1x - Orifice
- 2x - Abrasive O-ring
- 12x - 25 mm Fastening Screws
- 12x - 40 mm Fastening Screws
- 1x - Cut Bed Installation Tool
- 2x - Abrasive Plug
- 4x - High-Pressure O-Ring
- 1x - Phillips #2 Driver
- 1x - Needle Nose Pliers
- 1x - Deburring Tool
- 1x - File



Hose Kit

- 1x - High-Pressure Hose (sturdy black hose with metal connectors)
- 1x - Water Inlet Hose (3/8" diameter white hose)
- 1x - Water Drain Hose (1/2" diameter white hose)



Oil Kit

- -1x - Oil
- 1x - Oil Funnel

Install WAZER

Estimated Time: 120 minutes
Requires two people.

Before your first Cut on the WAZER you will need to set up your machine. Here is what you will do:

- Install the Pump Vent Cap
- Establish three water connections
- Install Inlet Water Filter and On/Off Valve
- Establish three cable connections
- Anchor WAZER to the wall

Install Pump Vent Cap

The Pump Box is shipped with a red Oil Cap that seals the oil chamber to ensure the Pump Box does not leak oil during transport. This red Oil Cap must be replaced with the yellow Pump Vent Cap prior to turning on the unit.

NOTICE Running the unit with the red Oil Cap will damage the Pump Box, and this damage WILL NOT be covered under warranty.

To install the Pump Vent Cap:

1. Loosen the four fasteners that hold the cover on. They will remain captured on the sheet metal cover. You should be able to loosen these Pump Box Cover bolts with the tools provided. Two are located along the back edge and two on the bottom front edge.

NOTICE DO NOT tilt the Pump Box backwards onto its water connections.

2. Remove the gray Pump Box cover by pulling the bottom front edge forward and top edge up.

WARNING NEVER remove the Pump Box cover while the Pump Box is connected to power or during operation.

3. Remove the red Oil Cap with the provided 17 mm wrench and replace it with the yellow Pump

Vent Cap found in the white box in the Setup Kit. Tighten the cap until it is finger tight and retain the red oil cap for later shipping.

4. Replace the Pump Box cover and tighten the Pump Box Cover bolts so that the cover is securely fastened. Ensure that they are well-secured in order to prevent unwanted vibration.

5. Visually inspect pressure release valve, make sure the tamper-proof mark is unbroken. If found broken, please contact WAZER for assistance.

You will be required to replace the oil in the Pump Box every 300 hours of run time. For more information, see Maintenance > Maintenance Procedures > Pump Box Oil Change.

To see the full required maintenance for the Pump Box, refer to Maintenance > Maintenance Schedule.

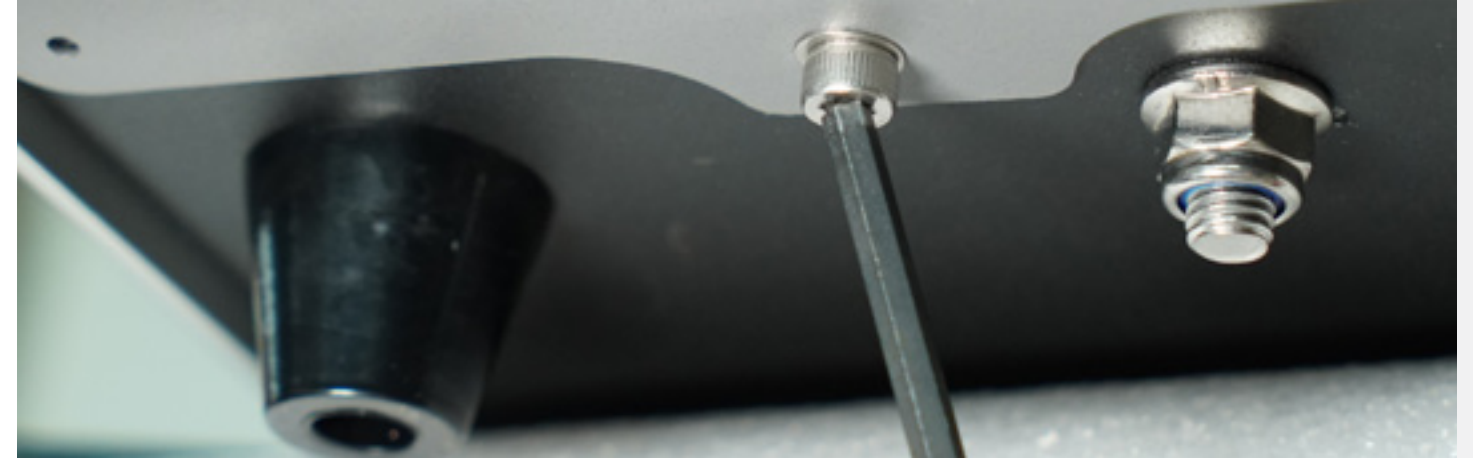

Water Connections

WAZER needs to be plumbed into your water lines. Here is a diagram of the system:

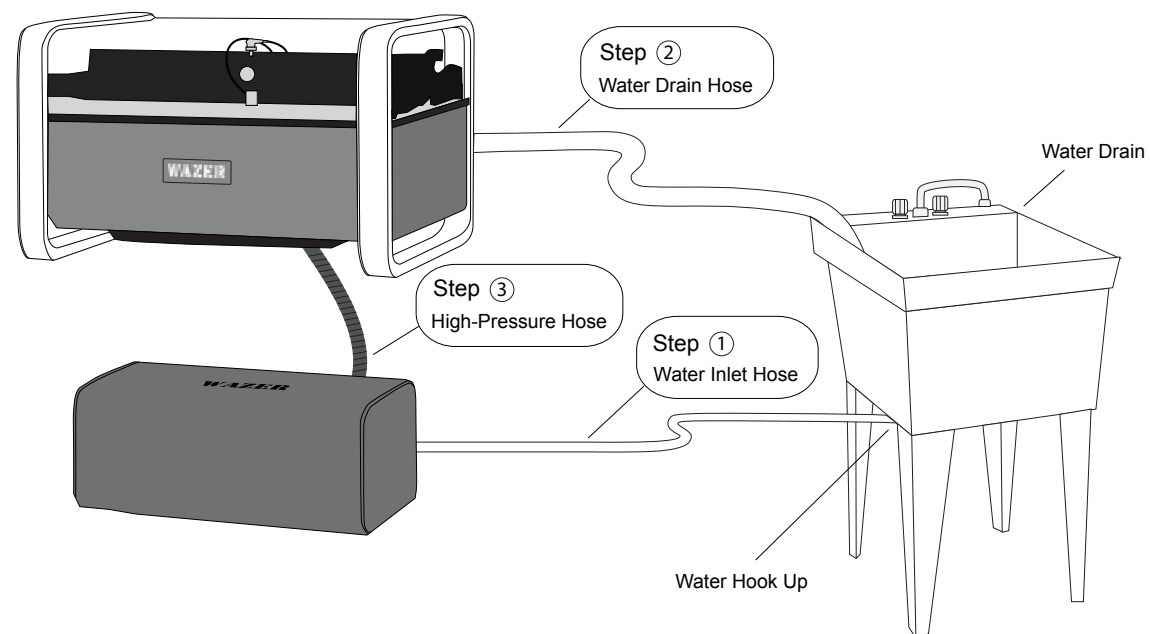

Installation has three steps:

- Hose 1: Water Inlet Hose (3/8" diameter White Hose)
- Hose 2: Water Drain Hose (1/2" diameter White Hose)
- Hose 3: High-Pressure Hose (Sturdy Black Hose)

Each hose is critical for operation. The Water Inlet Hose provides water for cutting. The Water Drain Hose disposes water. The High-Pressure Hose delivers high-pressure water from the Pump Box to WAZER. There are also several connections that cover other essential functions.

The provided Plumbing Kit should be compatible with most home or commercial plumbing. If the supplied fittings are not sufficient, your local hardware store will have additional adapters and connectors. If you are uncomfortable with this part of the setup, have a professional plumber complete this part of the installation for you.

NOTICE WAZER should never be configured to have its drain water recirculate into its Water Inlet Hose. This will destroy the Pump Box and void your warranty. Visually check High-Pressure Hose before installation. If the High-Pressure Hose outer layer has been damaged down to the outer wire layer, the High-Pressure Hose shall be withdrawn from use. Contact WAZER for replacement

Quick Connect System

We have provided a Push-to-Connect ("John Guest" style) system for both hoses.

This system requires no tools to lock or unlock hosing from the fittings. To lock the hose into the fitting make sure the end of the hose is cleanly cut and push it into the fitting. When you push the hose into the connector you will feel some resistance. Push past this resistance to fully seat the hose. The resistance is from the fittings O-ring sealing around the hose.

Don't be afraid to push forcefully to ensure you have fully seated the hose into the fitting.

To unlock the hose from the fitting, push the collet into the fitting and pull the hose out of the fitting (in the opposite direction). Again, this may take some force.

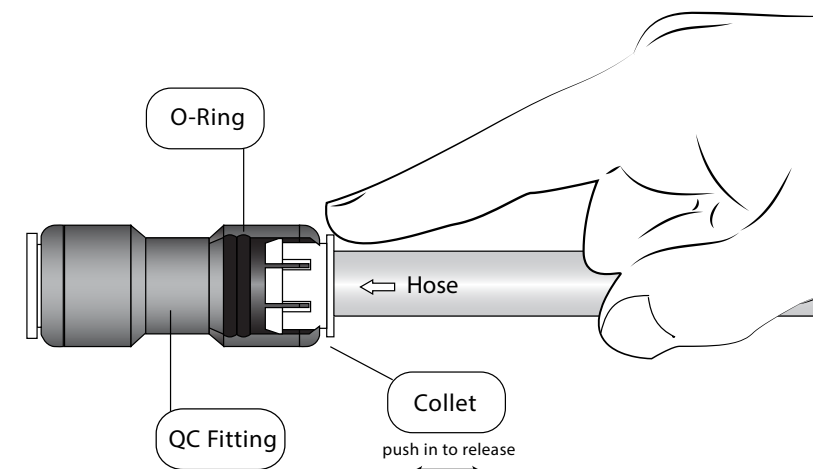

① Push Hose straight in as far as it will go.

② Hose is secured in position.

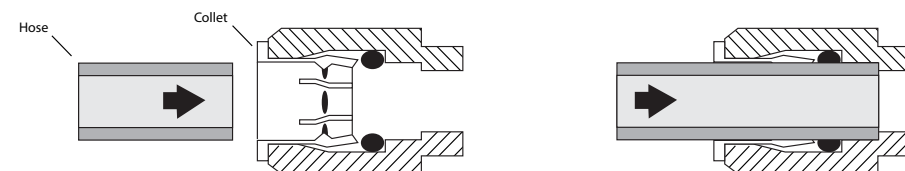

③ Push in collet to release Hose.

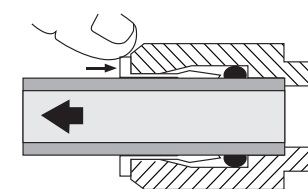

Hose 1: Install the Water Inlet Hose

The Water Inlet Hose needs to be connected to your water source at one end and to the Pump Box at the other end.

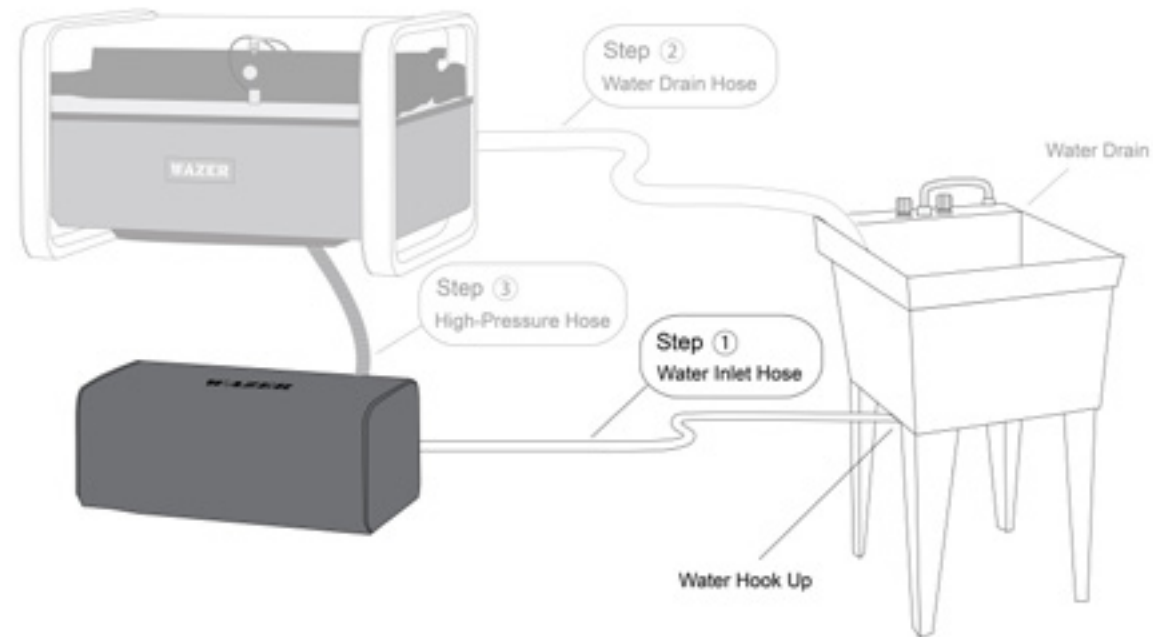

1. **Make sure the Pump Box is placed near its final location.**
Leave access to the rear of the unit.
2. **Connect Water Inlet Hose to Pump Box:** In your Accessory Kit, you will find a Water Inlet Hose (3/8" diameter White Hose.) Connect this hose to the Water Inlet Connection on the rear of the Pump Box. Leave enough slack in the hose to be able to pull the Pump Box out, remove the cover, and access the rear if needed in the future.



3. **Route Water Inlet Hose:** Route the rest of the hose to your water source. We recommend routing along piping or at the base of a wall. Do not place the hose near items that could cause abrasion (i.e. bolts, sharp metal plates, etc.).

Every installation will be different, but we recommend using zip ties and the provided hose routing anchors to help with tidy routing. Do not cut the hose yet.

Here are some routing examples that may be helpful:



4. **Connect Water Inlet Hose to water supply:**
Now we will make the connection to your plumbing. We have provided hardware for two types of connections.

You will either use:

- the Garden Hose Water Inlet Adapter, or
- the Sink Adapter.

NOTE: Pick whichever one is most appropriate for your current setup. If both options are available, we recommend the Sink Adapter because you can leave the hose installed permanently, whereas this may not be the case for the Garden Hose Adapter.



GARDEN HOSE ADAPTER

SINK ADAPTER

NOTICE

DO NOT cover the Pump Box.
DO NOT place the Pump Box in a confined area.
The Pump Box generates significant heat that needs to be expelled and should be visible at all times to inspect for leaks.

Here are images showing the two types of connection options:

Option 1: Sink Adapter (Recommended)

In the Plumbing Kit you will find a Sink Adapter, which is a "Tee" connector compatible with most common under sink fittings.

To install:

1. **NOTICE** Turn off the water supply valve that provides water to the line you want to use to connect your WAZER. (If you're not sure about this step, you may need help with this section of the installation.)
2. If you have a faucet attached to that line, turn it on to drain the line and confirm that the water supply is fully turned off.



3. Select an appropriate wrench to loosen the connection of the water supply you have chosen. A common adjustable wrench will work in most cases.
4. Unscrew the existing sink connector from the water supply.
5. Screw the Sink Adapter into the water supply.
6. Reinstall the faucet supply into the threaded side of the Sink Adapter.
7. Do NOT cut the end of the Water Inlet Hose to size yet!
8. DO NOT turn on the water supply valve yet.
9. Move on to Hose 2: Install the Water Drain Hose.

Option 2: Garden Hose Adapter

These threads are often found in commercial buildings, garages, and workshop sink faucets. In your Plumbing Kit you will find the Garden Hose Adapter.

To install:

1. This Garden Hose Adapter will thread into a garden hose or sink faucet.
2. Install the Garden Hose Adapter. If your tap does not have a garden hose thread, use the orange adapter.
3. **DO NOT** cut the end of the Water Inlet Hose to size yet.
4. **DO NOT** turn on the water supply valve yet!
5. Move on to Hose 2: Install the Water Drain Hose.



NOTICE If this location has separate hot and cold water supply lines, install using the cold supply line. NEVER use hot water. Hot water will damage WAZER.



Hose 2: Install the Water Drain Hose

WAZER outputs a significant amount of water during cutting. For this reason, the Water Drain Hose must be connected to your drain before operation.

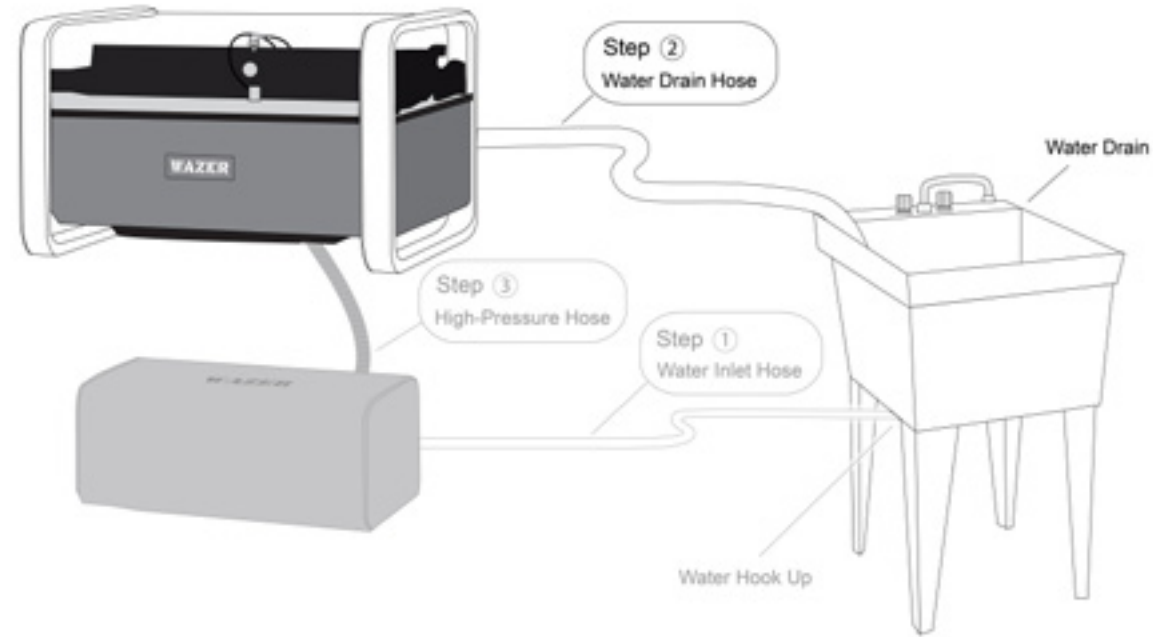

- 1. Connect the Water Drain Hose to WAZER Main Unit**
In your Accessory Kit, you will find a Water Drain Hose (1/2" diameter White Hose). Connect this hose to the Water Drain Hose Connection located in the back-right corner of WAZER. Note that the Water Drain Hose Connection swivels for more direct routing.
- 2. Route the Water Drain Hose**
This will likely be similar to your Water Inlet Hose routing. Zip tie the hose to other plumbing or use the provided wall anchors; avoid rough or sharp contact points.
- 3. Secure this to the drain**
It is OK for the Water Drain Hose to empty into a basin, as long as the hose is well-secured.

You may choose to untwist the twist tie holding the Signal Cable and Power Transformer wire to the back of WAZER for better access to the Water Drain Hose Connection and to the High-Pressure Hose Connection.

Make sure the drain is no more than 4 feet above WAZER. Note that WAZER outputs a significant amount of water while cutting. An unsecured hose can quickly spill large amounts of water.

Make sure you are draining waste water appropriately. The water drained from WAZER is partially filtered. There will likely be some Used Abrasive and Material in the drained water.



Hose 3: Install the High-Pressure Hose

The High-Pressure Hose transfers high-pressure water between WAZER Main Unit and the Pump Box.

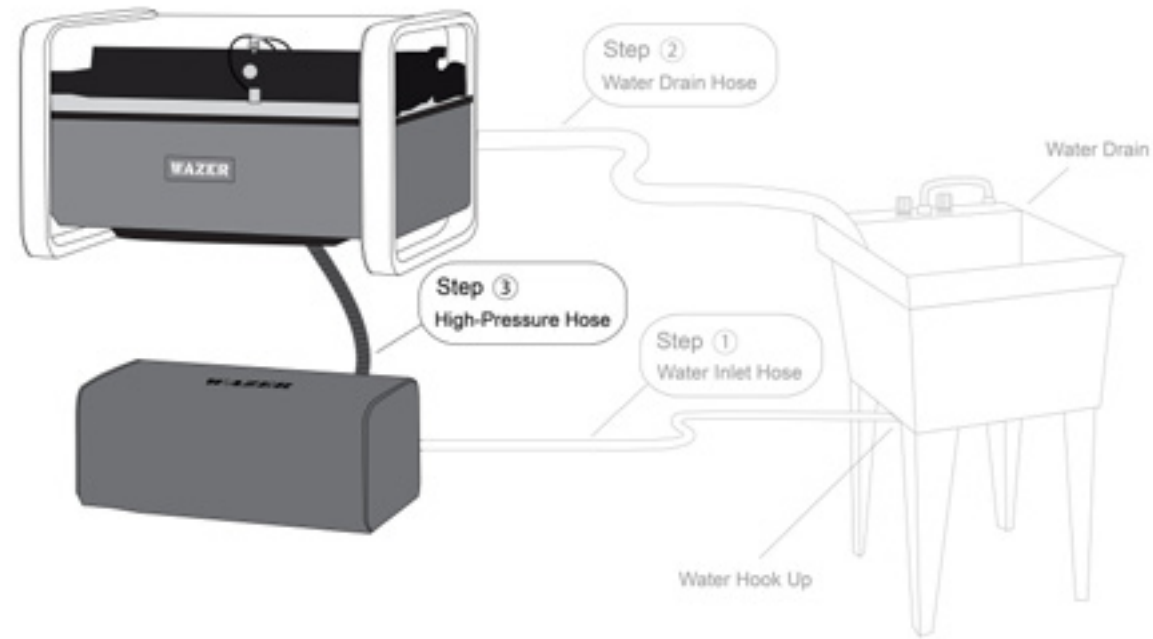

This hose is 5 ft. long. Ensure that it reaches between the two units without inducing stress at the joints. Do not route this hose in a way that will cause abrasion, pinching, or puncture. In particular, check for pinching between your desktop and the wall.

This hose has Quick Connect fittings attached at either end. To make the connection, pull back the collar and then push the female end firmly into the High-Pressure Hose Connection, making sure to seat the fittings completely.

1. Connect one end of the High-Pressure Hose to the High Pressure Hose Connection located on the back of the Pump Box. **Ensure the fitting is fully seated and the collar has snapped forward. Pull on the hose to be certain of the connection.**
2. Connect the second end to the High-Pressure Connection located on the back corner of WAZER. **Ensure that fitting is full seated and the collar has snapped forward. Pull on the hose to be certain of the connection.**

NOTICE Make sure the Pump Box is in a location that does not cause added stress to the High-Pressure and Water Inlet Hoses.

Make sure the High-Pressure Hose does not bend too sharply coming out of the back of the Pump Box. If there is a sharp bend, the High-Pressure Connections will experience uneven stresses. This stress will cause the internal O-Ring to fail and release high-pressure water.

If you notice water leaking from your High-Pressure Connections, please refer to our website.

If there is a leak or things get wet that likely shouldn't have, please turn everything off, wipe it down, and LET IT DRY overnight before seeing if anything was damaged and is still working.

Visually check High-Pressure Hose before installation. If the High-Pressure Hose outer layer has been damaged down to the outer wire layer, the High-Pressure Hose shall be withdrawn from use. Contact WAZER for replacement



Finalize water connections

- Install Water Filter
- Install the On/Off Valve
- Perform a Leak Test

1. Install the Inlet Water Filter and On/Off Valve

Once you have completed the three hose connections, install of the Water Filter and On/Off Valve needs to be done. They should be placed in a convenient location within the path of the Water Inlet Hose. We suggest placing it as close as possible to the water supply in case of damage to the hose farther downstream. Make sure the location of these components are easily accessible so that users can easily turn it on and off as well as monitor the inlet pressure and cleanliness of the filter on a regular basis.

- Ensure that the water supply to the Water Inlet Hose is turned off.
- Open your "WAZER Inlet Water Filter" box.
- Attach the two push-to-connect fittings to the inlet and outlet of the water filter by tightening them onto the threads
- Using the Sheetrock anchor and/or fastener, mount the bracket to your selected surface. A single fastener in the middle of the bracket is all that is needed to mount it.
- Cut the Water Inlet Hose with a sharp box cutter so that it can be routed to the outlet of the Water Filter, which you can identify with the arrow indicator on the water filter. We recommend leaving some slack in the line to allow for the water filter to be dismantled from its bracket if needed in the future.
- Cut a small section of the leftover Water Inlet Tube (12"-24") with a sharp box cutter and insert it into the inlet side of the Water Filter. Insert the other end of the cut hose into the On/Off valve.
- The remainder of the Water Inlet Hose can be cut to length to be routed between your sink adapter or Garden Hose Adapter installed at the beginning of this hose setup procedure. We recommend leaving enough slack to create a small loop in the line near the connection point. This allows extra slack to reposition in the future and relieves the joints to prevent leaking.
- Attach the silicone "flushing" hose with the hose clamp to the bottom of the Water Filter. You can find instructions on this in Section 7 Maintenance>Misc Maintenance Procedures>Cleaning the Water Filter Inlet

NOTICE Make sure to fully seat the hose into the On/Off Valve and Water Filter. You will feel a level of resistance (the seal) that you need to push past until the hose is fully seated in the connection. A total of about 1" of hose should be inserted into each side of the On/Off Valve.

It is important to shut the Water Inlet Hose off whenever WAZER is left idle; not doing this could lead to a massive water leak or damage to the unit. The valve also acts as a quick access safety mechanism to help limit damage in the event that an accident occurs.

2. Perform a Leak Test

- Inspect all water connections. Make sure every connection is well-seated and matches the descriptions in this User Manual.
- Turn on the water supply to the Water Inlet Hose, and turn on the On/Off Valve
- Inspect every point in the connection for leaks.
- Leave the water supply on for a few minutes and recheck the connections for any slow drips.
- Shut the On/Off Valve before continuing on to the next section.

The On/Off Valve is OPEN when the handle is parallel with the hoses.

The On/Off Valve is CLOSED when the handle is perpendicular to the hoses.

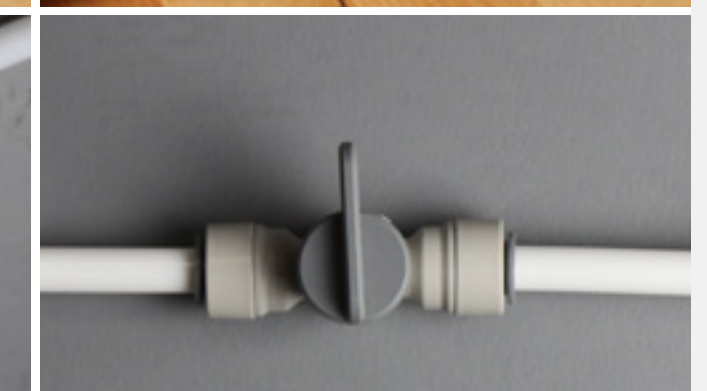

Power Cables

There are three electrical connections you need to make with WAZER:

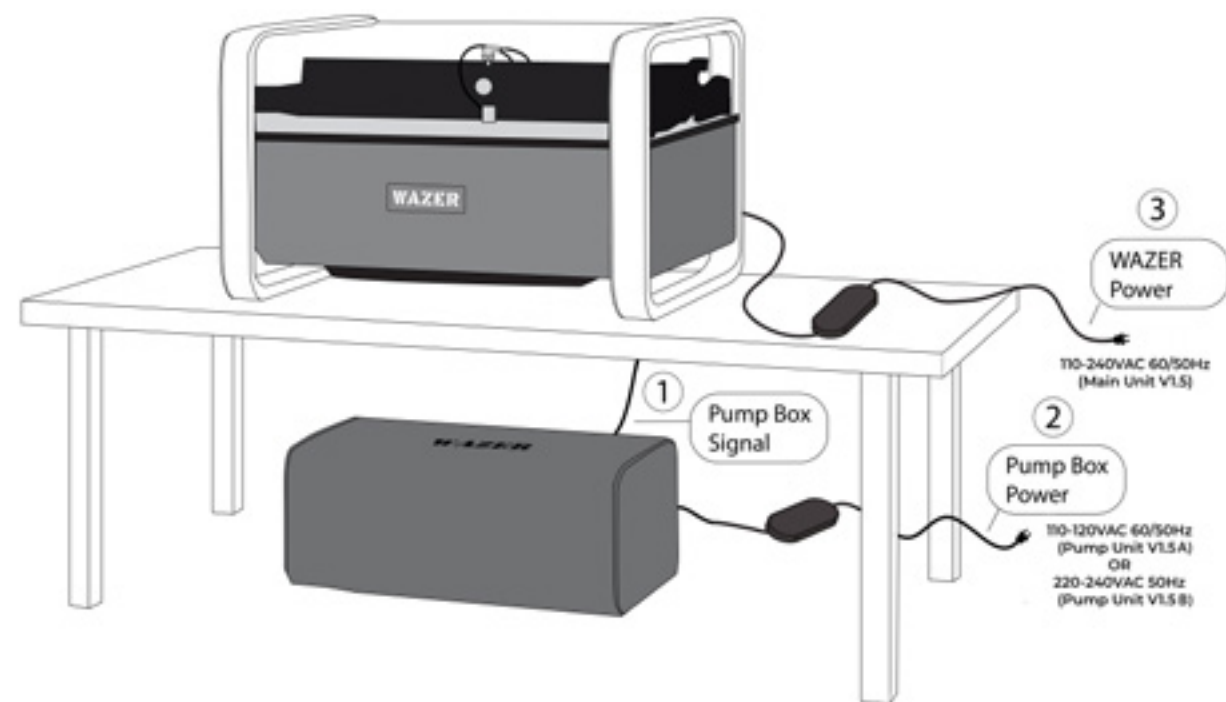

1. Establish the Pump Box Signal Connection

This is a cable that is permanently attached to WAZER Main Unit and needs to be connected to the back of the Pump Box.

- Untie the twist tie holding the Signal Cable to the back of WAZER.
NOTE: The WAZER Power Transformer wire is bundled with the Signal Cable. Set this aside for later.
- Unscrew the blue Cap on the Pump Box connector.
- Line up white dots on the connector.
- Insert the connector into the Pump Box and screw the blue Retention Ring on (finger tight is sufficient.)
- We suggest routing this wire along the High-Pressure Hose using zip ties.

2. Connect the Pump Box Power Cable



The Pump Box comes with a protected Pump Box Power Cable. Attach this Pump Box Power Cable to an appropriate wall receptacle given the model you have purchased and your home setup. If you are connecting your 110 VAC 60hz WAZER (designated as V1.5A), make sure to check if your wall breaker is 15amp or 20amp. As explained in the “Choosing a Location for WAZER” section, if you only have 15amp circuits available to you make sure your pump unit is on a different circuit from your main unit to avoid tripping your breaker.

- When you plug in the Power Cable, you must press the RESET button on the GFCI/PRCD. Look for a green light to turn on.
 - Press TEST button to ensure GFCI/PRCD functions properly. Then press RESET button to re-start the GFCI/PRCD. We recommended to check this safety function every time WAZER is turned on.
- ### 3. Connect the WAZER Power Cable
- WAZER runs on 24 VDC, which requires a Power Supply. You will find the Power Supply adapter taped to WAZER; remove the Right-Side Access Panel for better access. The WAZER Power Cable for the Power Supply can be found in the Accessory Kit.
- WAZER has a current draw of 2 Amp. If you are in a 110VAC region and have the 110vac Pump Box (V1.5A) plugged into a 15 Amp Circuit, you will need to run WAZER off an entirely separate circuit. Make sure to plug the WAZER Power Cable into an outlet on another circuit.
 - If you are in a 110VAC region and have the 110vac Pump Box (V1.5A) plugged into a 20 Amp Circuit, you can run WAZER and Pump Box off the same circuit.
 - If you are in a 220VAC region, the WAZER Main Unit and Pump Unit can be on the same circuit provided the breaker is >11 amps.



⚠WARNING

- Ensure that you place the Power Supply in a location free of drips and potential leaks from WAZER. **DO NOT place the Power Supply under WAZER.** Find a good location on the tabletop next to WAZER. Please do not put any other electric or electronic equipment under WAZER
- In the event of a malfunction or breakdown, grounding provides a path of least resistance for electric current to reduce the risk of electric shock. This tool is equipped with an electric cord having an equipment-grounding conductor and a grounding plug. The plug must be plugged into a matching outlet that is properly installed and grounded in accordance with all local codes and ordinances.
- If Power Supply cable or Pump Box cable is damaged or worn, stop installation or operation IMMEDIATELY. Contact WAZER support to have it replaced.
- Make sure the tool is connected to an outlet having the same configuration as the plug. No adapter is available or should be used with this tool. If the tool must be reconnected for use on a different type of electric circuit, the re-connection should be made by qualified service personnel; and after re-connection, the tool should comply with all local codes and ordinances.
- To reduce the risk of unintentional starting, make sure the WAZER main unit switch is in the off position before plugging in. Make sure switch is in off position before plugging in.

*Please double check to make sure the local power supply fit the model you have purchased, before you plug WAZER in.

Anchor WAZER to the Wall VIDEO

Now that you have completed all the necessary connections, position WAZER and Pump Box into their final locations.

The Pump Box can be slid further under the bench or WAZER so that it is out of the way. Make sure to allow for plenty of air circulation around the Pump Box and do not stress the water or Power Cables on the back of the unit.

The Wall Anchor helps to ensure the accuracy of the Cut by dampening any vibration you may cause by accidentally bumping into WAZER while it is cutting.

⚠WARNING When WAZER is filled with water it will weigh approximately 400 lbs (180kg). To ensure the safety of the WAZER and its users it is required that you anchor the machine to a wall or solid structure with the provided bracket and hardware.

To anchor WAZER:

1. Install the Wall Mount Bracket using the provided hardware. The bracket is installed on the back-right side of WAZER (when viewed from behind) with a 4 mm Allen key.
2. Move WAZER into position and mark the wall where you intend to drill holes for the appropriate Wall Mount Bracket.
3. Move WAZER away from the wall to drill holes or install wall anchors. Then, move it back and install the appropriate screws through the bracket.

Note that wall anchors for both drywall and concrete are provided. Please install the appropriate hardware.



Cutting With WAZER



Learn the process of cutting with WAZER by completing the Welcome Cut.

Cutting with WAZER requires a specific procedure that must be followed. You will find a checklist at the end of this chapter that you can post prominently as a reminder.

The following procedures must be followed to cut with WAZER:

- Preparation
- Startup
- Cutting
- Finishing
- Shutdown
- Maintenance Between Cuts

User expectations:

- It takes a few cuts and a few hours of running and experiencing the behavior of the machine in order to be able to run it confidently on your own.
- If you have any doubts or uncertainties:
 - Review some of our videos online
 - Re-familiarize yourself with this user manual
 - Refer to the checklist at the end of this section
 - Contact WAZER customer support for assistance
- Performing the welcome cut and also starting off with a few simple custom designs is highly recommended.

Preparation

Do not attempt to cut if you have not completed the Setup outlined in Section 4 of this User Manual. Also, refer to WAZER System Dissection in Section 3 to familiarize yourself with all the components of WAZER. We will be referencing these parts by name throughout the remainder of this section.

Checklist: Before You Cut

Complete this procedure before every Cut. If this is your first time using WAZER, take some extra time to make sure everything is done correctly.

1. **⚠ WARNING** **Wear Proper Personal Protective Equipment**
Eye protection is required whenever using WAZER. Non-slip footwear is also recommended.
2. **📢 NOTICE** **Open On/Off Valve**
Open the On/Off Valve, which will turn on the water supply. Forgetting to do this could lead to damage to the Pump Box and to a Failed Cut. Make sure that water is flowing to WAZER and that you know how to turn the water off in case of an emergency.
3. **📢 NOTICE** **Fill the Tank** **Do NOT run WAZER with a low water level in the Tank.** The water in the Tank is critical to protect the bottom of WAZER from the Jet during cutting. Make sure the Tank is filled approximately to the top level of the Cut Bed. WAZER has sensors that can measure the amount of water in the Tank, so the Water Level does not need to be precise; as long as it is within 1/4" above or below the top surface of the Cut Bed. It will take approximately 15 gallons of water to reach this level.

To fill the Tank, open the Door and manually add water with a bucket or a hose. This will be required the first time you use WAZER, when servicing the machine, and if WAZER has been sitting idle resulting in water evaporation.
4. **Level the Cut Bed**
You may notice that the Cut Bed and water level are not parallel. This may occur if the machine is not level on the surface it is placed OR if the Cut Bed is not level. If your machine is not level you may have water management errors in the future. If your cut bed is not level, it is guaranteed that you will have back flows and failed cuts in the near future. We highly recommend you check how level the machine is by referring to Maintenance > Leveling the Cut Bed.
5. **📢 NOTICE** **Secure the Water Drain Hose**
Ensure that the Water Drain Hose is correctly positioned, free of obstructions and secure to avoid water spillage.
6. **Check for Leaks**
Inspect the area around WAZER, Pump Box and accompanying hoses for leaks. If there is a leak or things get wet that likely shouldn't have, please turn everything off, wipe it down, and LET IT DRY overnight before seeing if anything was damaged and is still working.
7. **Confirm all Electrical Connections**
Ensure the Pump Box Power Cable and WAZER Power Cable are plugged into the appropriate outlets. Make sure that there is a solid green light illuminated on the GFCI/PRCD. If not, press the reset button on the module. Check that the Signal Cable is connected to the Pump Box.
8. **Position Water Sensor Alarms**
Take the two Water Sensor Alarms from the Accessory Kit and place them around WAZER. We recommend placing one on the table below the Tank, and the other behind the Pump Box. Make sure they are turned ON. These sensors will sound an audible alarm if they get wet, alerting you to a possible leak. **Note that the Water Sensor Alarms are NOT connected to WAZER and will NOT pause its operation.** It is critical that you regularly test the sensors by touching the bottom pins with a metal object to ensure that they are working.

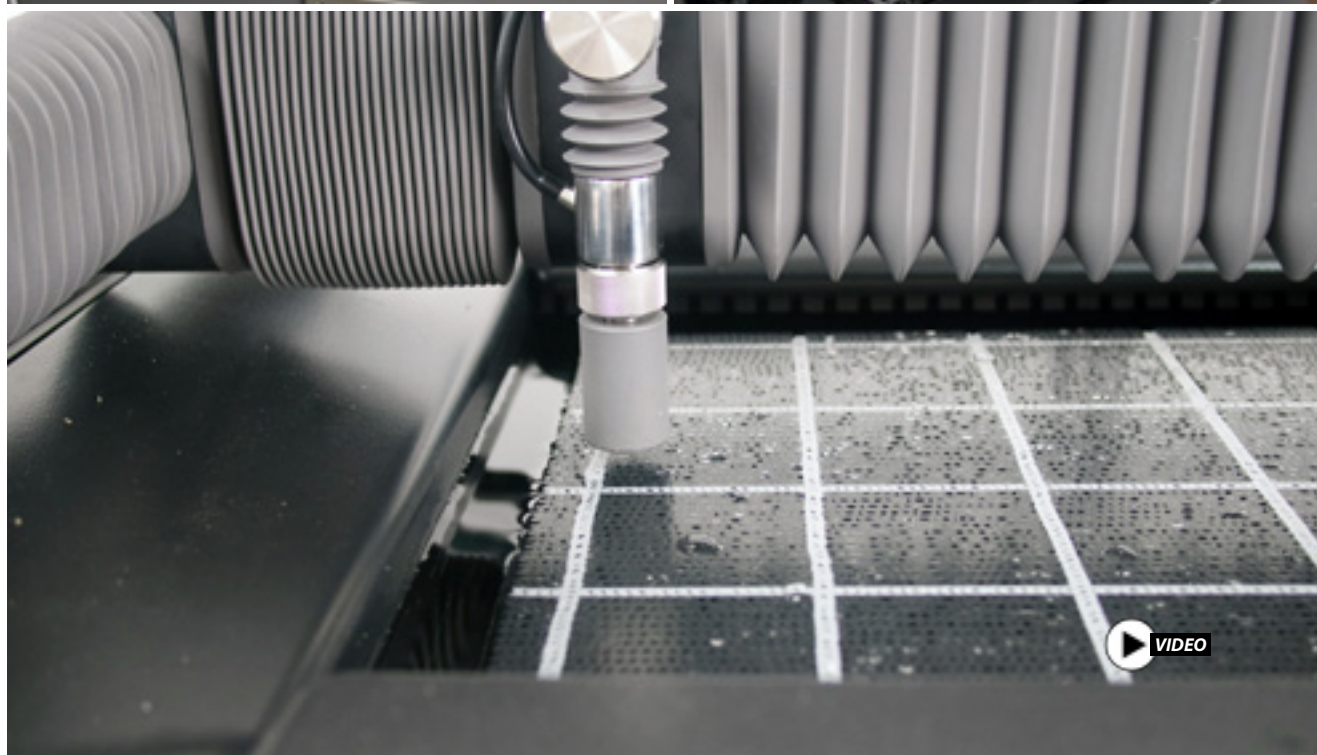
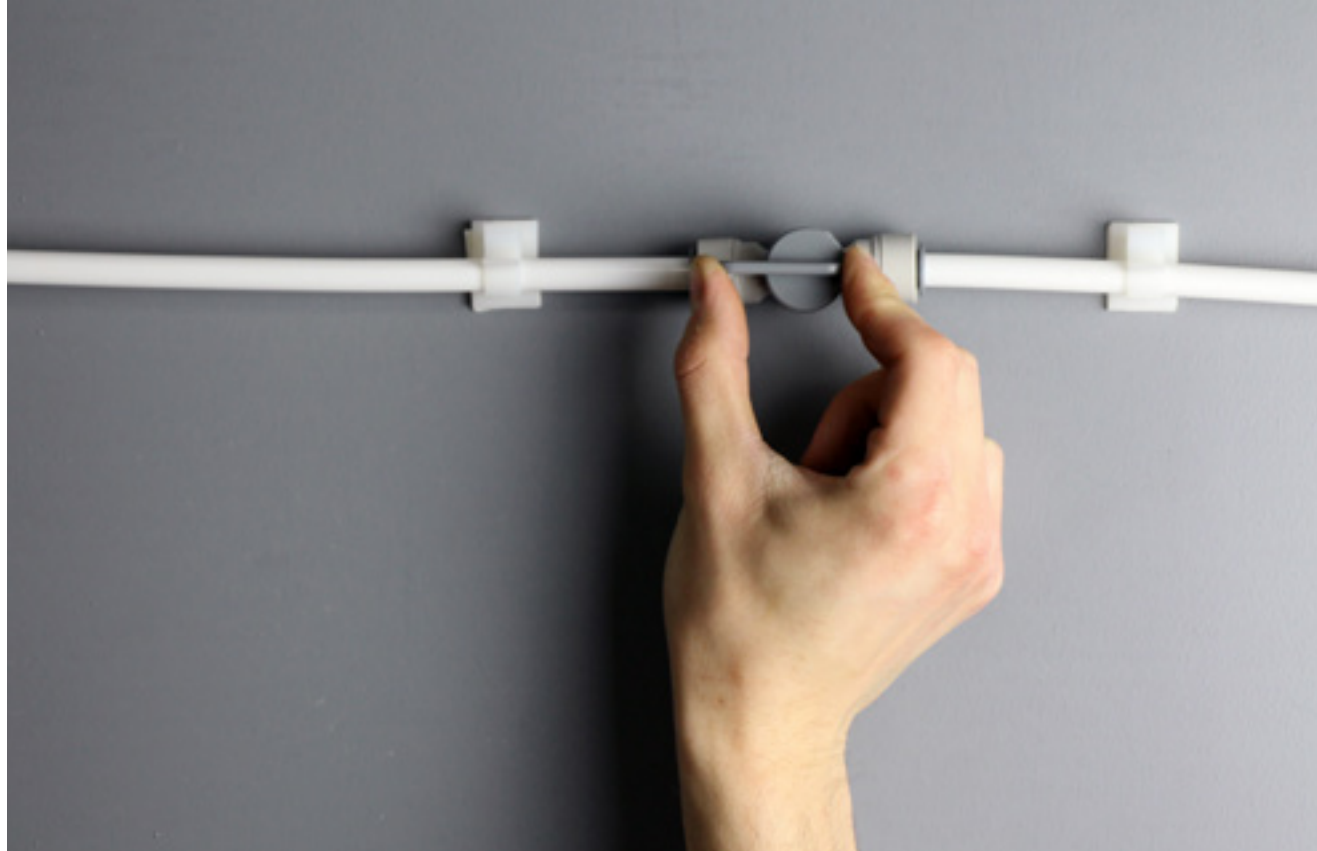

Startup

This section will guide you through the process of setting up WAZER to cut your Design.

Over time this process will be familiar to you, and the Control Panel prompts will likely be enough to walk you through the setup. For the first time WAZER user, we strongly recommend to follow every single step listed in this section. Additionally, at the end of this section you will find two copies of the "Cutting with WAZER Checklist" printed on water resistant paper. We highly suggest prominently displaying one of those pages in a highly visible location near your WAZER, for all users to reference with every cut.

Insert the SD Card VIDEO

Transferring Cut Files to WAZER is done through an SD Card. To transfer Cut Files onto the SD Card, connect the card to your computer, and drag-and-drop the Cut Files onto the SD Card.



WAZER has a slot near the Control Panel that accommodates a standard sized SD Card. It is important that you insert the SD Card before turning WAZER on.

An SD Card is provided with your Setup Kit. This SD Card contains the Cut File for the Welcome Cut. Place it in WAZER now.

Turn On WAZER

There are 5 things that can prevent your WAZER from turning on:

- The GFCI/PRCDs cords must be plugged into appropriate outlets as explained in the setup section of this user manual.
- The GFCI/PRCDs are reset and have a green light present. This must be done after being plugged in.
- Correct water level must be present in the tank. Too low or high of a water level and the corresponding float sensors will prevent machine turn on.
- The E-stop must be reset and in the up/disengaged position.
- The primary power switch that is located at the bottom right corner of the Main Unit and can be accessed by reaching under the right cover of the machine.

If you have correctly conducted all the steps outlined in this manual, you should only have to deal with the last two at this stage. If the E-Stop is engaged (in the down position), please turn it clockwise until it resets and pops up. Only use this switch in case of an emergency and not as a primary means of on and off. As your primary method of turning the machine on and off the Power Switch that is located at the bottom right corner of the Main Unit should be used. Reaching under the Right Side Cover will give you access to this Power Switch.

When WAZER is turned on, the Control Panel will present two options:

- Select Cut File: This allows you to select a Cut File and initiate a Cut.
- Setup & Maintenance: This allows you to choose from several setup and maintenance options that will aid in the upkeep of WAZER.

This is considered the main menu of the WAZER. You control WAZER via the onboard screen and keypad. The ">" symbol on the left indicates the current selectable field. The OK Button confirms a selection. Pressing the Left-Arrow key will take you back to the previous menu.

NOTICE When you first turn on WAZER, the Main Menu will be displayed on the Control Panel, and the Start/Stop Button will be flashing. If you remove the Right-Side Access Panel and observe the Control Box, all four of the LEDs on the left side will be on, the top and bottom lights of the middle column will be on, and the two middle LEDs of the middle column will be flashing. None of the LEDs on the right side will be on. WAZER will not be making any noise.

You will notice that there is no Power Switch for the Pump Box. This is because the Pump Box is controlled by WAZER through the Signal Cable. Please ensure that the Pump Box is connected to power, the green light on the GFCI/PRCD is on, and that the Signal Cable is connected.

If your WAZER fails to turn on, check the high and low float switch on the right side of the tank; the low switch should be submerged and the high switch should not be. If the water level isn't between those switches WAZER will not turn on. Top up or siphon out water as needed.

Now that you have your WAZER turned on we can use it to conduct the final two setup steps prior to starting your first cut. The first is priming your plumbing to ensure the lines are purged of any air pockets. The second is establishing your WAZER's water level.

Priming Your Plumbing

If this is your first cut, or this is your first cut after disconnecting a water line or sitting unused for some time, make sure you Prime the plumbing to ensure all the air has been purged from the water lines before starting your cut. If it isn't you are prone to see false water level management errors and interruptions during your cut. This procedure is about 5 mins and the steps are outlined in Section 7 of this user manual under Maintenance > Misc Procedures > Priming the Plumbing.

Establish Water Level

To ensure there are no water level management issues during your first cut we suggest you perform a water level setup. To do this, turn the water supply on to your WAZER and simply select "Setup & Maintenance>Maintenance>Water Level Setup" from your WAZER's controller menu. Follow the on-screen prompts to ensure that your WAZER establishes its water level. If you happen to run into an error the first time through this mode do not worry, just re-run it one more time. If it subsequently fails please visit our online resources section to troubleshoot the issue.

It is also advisable to perform this setup step whenever you have performed maintenance on the machine that may have altered the water level or if meaningful amounts of water have evaporated while the machine was not used. It just takes a few minutes but prevents a false water level management error from popping up and interrupting your next cut.

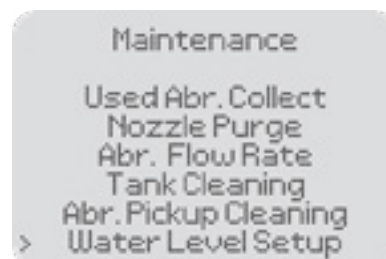

Transfer Cut Files to WAZER

We are finally ready to setup our first cut. To do so the next step is to transfer a Cut File to WAZER. A Cut File is a type of .gcode file with some WAZER-specific commands. This file includes all the parameters required to cut your Design. Follow control panel prompts.

Select a Cut File

Select Cut File on the Control Panel's Main Menu brings up a file selection menu that lists all the .gcode Cut Files on the SD Card. Select the Cut File that you would like to cut.



Selecting a Cut File will not immediately start a Cut. The Control Panel will walk you through a series of prompts before cutting your file. WAZER will never start cutting without your explicit consent. If you do not have an SD Card plugged in, the Control Panel will display the .gcode Cut Files that are located in WAZER's on board memory.

Initiate a Cut

If this is the first time using a new WAZER, select the Welcome Cut file. It is important to run this Cut File to ensure that WAZER is fully functional. It will also familiarize you with the basic WAZER functionality before learning the Wam software, which we will cover in the next section. You will find this Cut File on the SD Card that is provided in the Setup Kit. Go ahead and select "WelcomeCut.gcode".



Lift the Nozzle VIDEO

After selecting a Cut File, you will be prompted to lift the Nozzle. This is to ensure that the Nozzle does not crash into anything in its next automated action. To lift the Nozzle, loosen the Nozzle Lock Knob, lift the Nozzle by pushing it up and then tighten the Nozzle Lock Knob. Confirm this action has been performed by pressing "OK" on the Control Panel. This will initiate a homing routine. **NOTE: The Nozzle will start moving after you press "OK".**

Home WAZER

Upon confirmation, the WAZER will automatically home the Nozzle to the top-left corner of the Cut Bed. Once completed, the Nozzle will move to the top-left corner of your Cut File's Cut Extents (the Bounding Box around the Cut). This is the visual locator you will use to reference your Material's position when placing it on the Cut Bed. We address this in detail later on in the User Manual. WAZER will also Analyze the Cut File while it is homing. This should only take a couple seconds, depending on the size of the cut file.

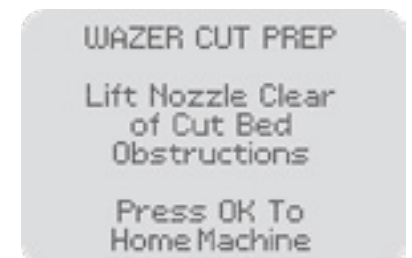



Load Abrasive VIDEO

After homing, WAZER will prompt you to check the Abrasive Level. **You must refill the Abrasive Hopper before running every Cut** so that WAZER can pause when it starts to run low on Abrasive and not after it has run out. The Abrasive Hopper will hold approximately 35lbs (16kg) of abrasive when full.

NOTICE Refilling the Abrasive Hopper completely is extremely important. Failing to fill the Abrasive Hopper sufficiently will result in a Failed Cut. This is because WAZER does not have a sensor to read the Abrasive Level, so it assumes that it is filled prior to the start of every Cut. If this is done correctly, WAZER will pause the Cut when the Abrasive runs low, then prompt you to refill the Abrasive Hopper and continue cutting. WAZER will pause after one hour of run-time to allow you to refill the Abrasive Hopper and to empty the Used Abrasive Buckets.

NOTICE Using an Abrasive that is not specified by WAZER may lead to poor quality and damage to your machine. You must use the Abrasive suggested on the WAZER website. The WAZER is calibrated to run with the 80 mesh alluvial garnet available for purchase at www.wazer.com.

To load Abrasive:

- Pull out the Abrasive Hopper, located on the left side of WAZER.
- We recommend using a large cup to pour the Abrasive through the two screens until the Abrasive Hopper is full. It is critical that you pour the Abrasive through the screens. If anything other than new, dry Abrasive falls into the Abrasive Hopper it can ruin your Cut and require time-intensive maintenance. The Abrasive should filter through the screens quickly. The filters will not clog as you pour.
- Fill the Abrasive Hopper until you see some Abrasive above the level of the screen on both sides. A small void may remain between the two screens. Close the Abrasive Hopper and confirm task completion by selecting OK on the Control Panel. It is okay if the Abrasive piles are a little uneven and begin to pile up in the center. Just add some Abrasive to the sides to help even things out.



Empty the Used Abrasive Buckets

Next, you will empty the Used Abrasive from the collection system. During cutting, Abrasive is constantly being introduced into the Jet. To prevent accumulation on the bottom of the Tank, the Used Abrasive is constantly collected and routed into two Used Abrasive Buckets located at the front of WAZER. **You must empty both Used Abrasive Buckets before every Cut.**

To empty the Used Abrasive Buckets:

- Remove the Front Tank Cover.
- Rotate the handles upwards and pull the Used Abrasive Buckets out of their retainers.
- Dump the Used Abrasive into a container to await final disposal. We suggest you first pour excess water out of the Used Abrasive Buckets; the collected Used Abrasive will have settled at the bottom.
- Replace the Front Tank Cover. You should feel it fall into place if installed correctly. You will also see the front of the handles sticking out beneath the front lip of the Front Tank Cover when correctly installed.
- Confirm task completion by pressing "OK" on the Control Panel.

Not all the Used Abrasive will be collected from the Tank and there will always be a few pounds that accumulate and remain in the Tank. This is not a concern. With that said, excess abrasive at the bottom of your tank can result in the Collection system getting clogged. Therefore we encourage running a Tank Cleaning Cycle in the following situations:- After cuts and before turning off your WAZER for a few days in order to collect the excess Used Abrasive. This will make sure the abrasive pickup ports are cleared and abrasive won't compact down on them, clogging the system up.

After your WAZER has been sitting for a set of days and before its next cut. This will loosen the excess abrasive at the bottom of your tank and in the collection ports, making the collection system more effective during cutting.

For your first cut you do not need to worry about this step, but going forward we highly suggest doing the Tank Cleaning Maintenance regularly. The details of conducting this procedure is found in Section 7: Maintenance.

Replacing the Used Abrasive Buckets is sometimes tricky, here are two techniques to help:

- Push the Used Abrasive Buckets down into their retainers to fill with water, so they do not float. The metal handles double as a locking mechanism to hold the buckets down. Rotate the handles so that they are straight up, push the Used Abrasive Buckets all the way down, and rotate the handle forward. The hooks on the handle should engage with the Tank and keep it down while it fills.
- You may realize the Used Abrasive Buckets sometimes cannot be fully pushed down into their retainers. This is because Used Abrasive has collected in the area under them. Simply clear this out with your hand (using gloves as sharp scraps from your cuts may exist) and then replace the Used Abrasive Buckets. If this happens, it may be time to do an additional Tank Cleaning Cycle through the Setup & Maintenance menu after your next Cut.

WAZER CUT PREP
Fill Abrasive
Hopper & Empty
Used Abrasive

When Completed
Press Ok

Failing to empty the Used Abrasive Buckets between Cuts will result in your Filtration System becoming clogged over time. The amount of time and work required to unclog the system is significantly greater than simply staying on top of regularly emptying your Used Abrasive Buckets and being diligent in performing tank cleaning cycles between cuts.

Dispose of Used Abrasive properly. The abrasive is inert, so it can be handled as a non-hazardous material and thrown away as garbage waste. However, it is your responsibility to check with your local regulations and requirements to make sure there are no restrictions around the materials you are cutting.

⚠CAUTION Bacteria can build up in the standing water of the Tank. Any injuries or cuts, even minor ones, should be treated with caution. If you have open wounds avoid contact with the water or wear gloves that do not expose you to the Tank water.



NOTICE Confirm the Water Supply is On

Water is supplied to WAZER via the Pump Box so that it can cut. Double-check that the On/Off Valve is on. It is critical to not overlook this step, because WAZER does NOT know if the water supply is on or off. Running WAZER without the water supply turned on will damage the Pump Box.

If you do happen to attempt to cut a file without the water on, you will immediately notice that something is wrong, because the flow will be weak, and the Jet will not cut through. In this case, DO NOT panic. Simply pause WAZER, turn the water supply on and start your Cut. More on how to pause WAZER later.

Fasten the Material  **VIDEO**

Securely fastening the Material to the Cut Bed is critical to the accuracy of your desired Cut. If your Material moves during cutting, the results the cutting results will be poor, or the Cut may fail completely.

If the shape you are cutting will be close to the edge of the stock Material make sure to not place fasteners in those areas. This will reduce the risk of the Nozzle crashing into those fasteners.

You can use any fasteners that are about 5 mm in diameter to secure your materials to the corrugated Cut Bed. The coarser the thread the better, hence wood and sheet metal screws are ideal. Be mindful of the Nozzle profile and the screw head size you choose to minimize Nozzle crashes and losing a Cut.

To fasten your Material:

- Place several Fastening Screws around the Material and screw them directly into the Cut Bed. You can insert a screw into any of the holes in the Cut Bed.
- Perform a quick check to make sure that the Material is large enough to accommodate the shape you want to cut.
- Place the Material on the Cut Bed and line up the top left corner of the Material with the center of the Nozzle (if you have extra Material, you may place it past the Nozzle center - higher and more to the left).
- Fasten the Material with the Fastening Screws in the Spare Parts bag, confirming that it cannot slide in any direction.
- Confirm task completion by pressing "OK" on the Control Panel.
- If this is your Welcome Cut, we already did this for you, so you can move on!
- Additional noise could be generated by the impact of water jet on the work piece. For prolonged cut job, ear protection is strong favored.

WAZER CUT PREP
Fasten Material
To Cut Bed
When Completed
Press Ok

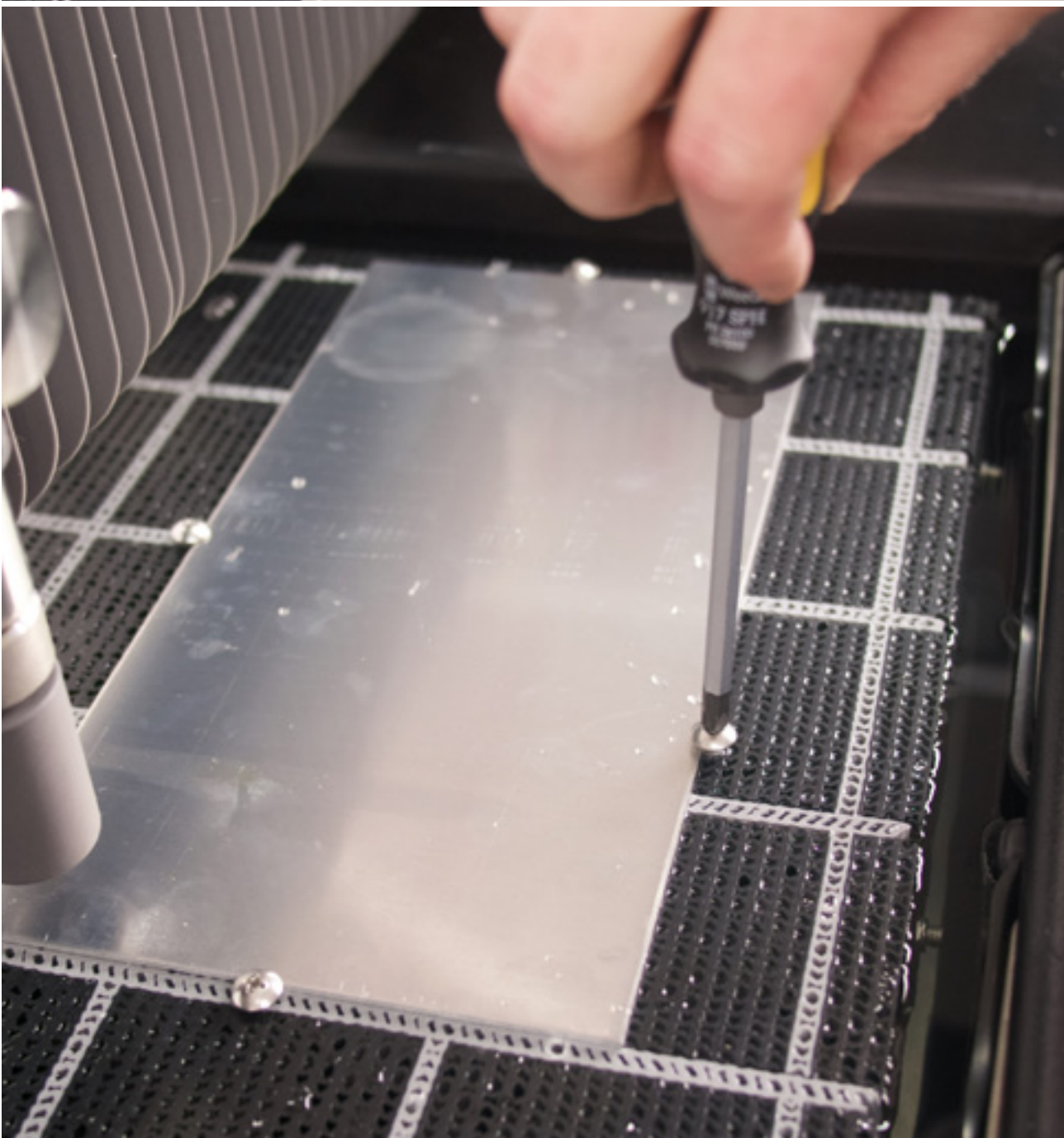
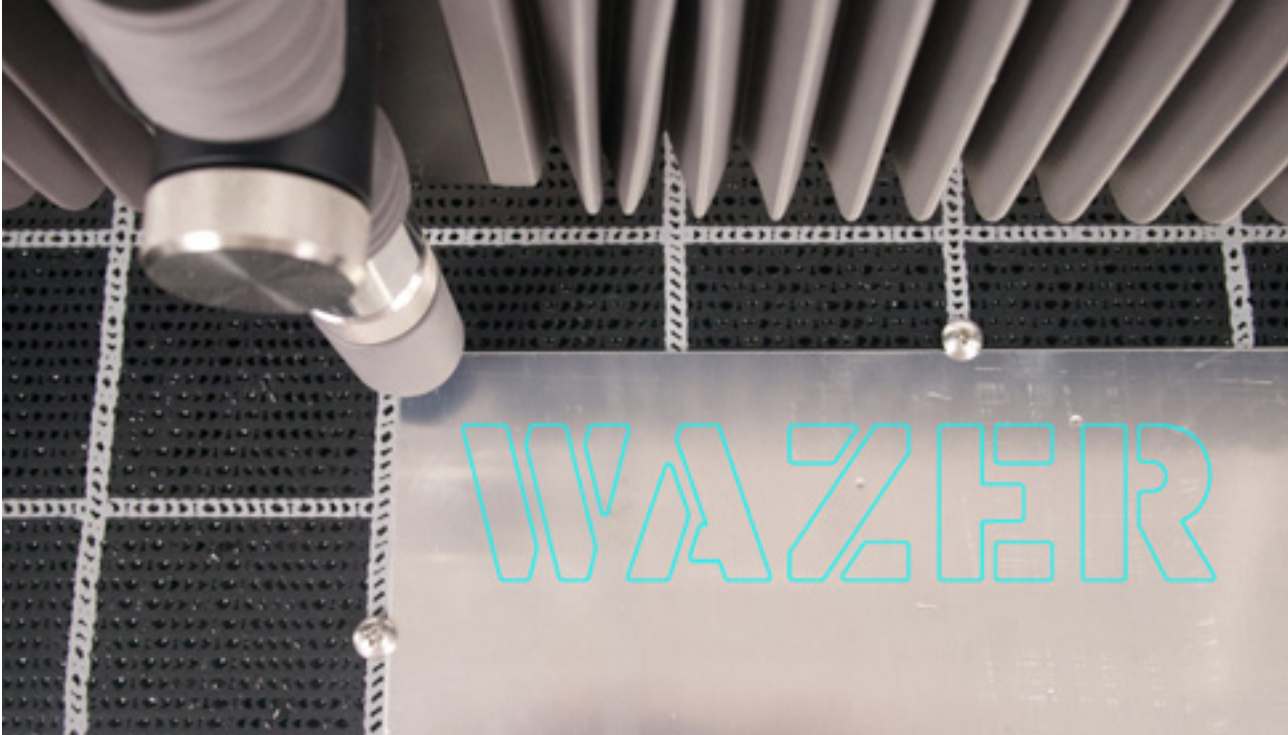

Set Nozzle Height

NOTICE Setting the height of the Nozzle relative to the Material is critical. If the Nozzle Height is set improperly, WAZER may not cut through the Material or the WAZER cutting head will come in contact with the material you are trying to cut resulting in a jam, clog, and lost cut.

To set the Nozzle Height:

- First, the Control Panel will prompt you to set the Nozzle Height.
- Grab the Nozzle Height Tool, which is the black cap on top of the Nozzle.
- Place the Nozzle Height Tool on top of your Material and loosen the Nozzle Lock Knob on the Nozzle.
- You may Jog the Nozzle over the Material using the keypad. This will not affect the starting position for the Cut.
- Slide the Nozzle Height Tool up against the Nozzle Cover, and gently lower the Nozzle onto it. The flange of the Nozzle Height Tool should now be caught between the Material and the Nozzle, which is hidden under the gray Nozzle Cover. As long as the Nozzle Height Tool is between the Nozzle and the Material to be cut, you can trust that it is set properly.
- Tighten the Nozzle Lock Knob after the height is set properly. This should be tightly snug by hand to ensure that it doesn't vibrate loose while cutting. If it comes loose it will most certainly result in a jam, clog, and lost cut.
- Pull the Nozzle Height Tool out from under the Nozzle and replace it on top of the Nozzle.
- Confirm task completion by pressing OK on the Control Panel.



When setting the Nozzle Height, you should feel some resistance, but the Nozzle should not be so tight against the Nozzle Height Tool that you cannot easily slide it out. Additionally, when you pull the nozzle tool out from under your cutting head, be sure that the material hasn't flexed away from the Cut Bed. We have noticed, on occasion, thin materials bowing after being fastened down. Often this was not realized because the setting of the Z-height with the tool would push the material down. This made it seem like the offset was correct, but after taking the tool out it would bow up again, sometimes having the material contact the cutting head without us noticing. Be mindful of this because if this happens you will have a jam, clog, and lost cut. If the Nozzle Height is set too low, it might crash and ruin your Cut which would require significant maintenance. If the Nozzle height is set too high, you may notice a small effect on your Cut Quality. It is better to be slightly too high than to be too low. If you lost your Nozzle Height Tool, simply slide a 0.098" (roughly 2.5 mm) piece of material between your Material and the Nozzle.

Perform a Final Check

A Cut can be costly. Take advantage of the Control Panel's preview features to ensure that you positioned the Material correctly.

We highly recommend that you use one of these features before starting a Cut:

- **Check Cut Extents:** Select this feature and the Nozzle will slowly trace a rectangle that will designate your Cut Extents (essentially the smallest rectangle that fully encompasses your Cut). As it moves, the center of the Nozzle should never cross the edge of the Material that you fastened to the Cut Bed.
- **Dry Run:** Select this feature and the Nozzle will trace the path of the entire Cut File without releasing water. This is the more time-consuming option, but fully verifies the setup since it replicates the final Cut Path.
- **Move origin:** Allows you to move the cut to a new location on the cut bed. When this feature is selected, you can move the nozzle to a new starting location by pressing the arrow keys. Once the new location is set, the firmware checks the cut extents. If these are outside due to the shift you will get a prompt. If the cut falls within the cut bed you can go to the material menu and start the cut. Each press of the button moves the gantry by 10 mm.
- **Restart Cut:** Lets you start the cut from any point within a cut file, thereby allowing a restart from the position the cut failed. When this option is selected, the nozzle moves along the cut path in dry run mode (without water and abrasive). The user can visually access where the cut has failed and when the nozzle reaches that location the user can start cutting by pressing start. The feature pierces at the restart location and completes the cut file as designed.



Finalize the Setup

Once you have checked your setup select "Cut Material" on the Control Panel. WAZER is now ready to cut.

Start Cutting with WAZER

Now that you have completed the setup, you can begin your Cut:

- **⚠WARNING** Make sure you are wearing proper personal protective equipment.
- If the Door is open, you will be prompted to close it. Once the Door is closed you can proceed by pressing Start/Stop or cancel by pressing the OK Button.
- **NOTICE** Verify that WAZER is cutting properly. Paying close attention at the start of a Cut will help prevent damage to WAZER or property.
 - When WAZER starts, you will first hear the Main Unit gantry move to its pierce location.
 - This will be followed up by the Pump Box turning on and a vibration sound coming from the Main Unit.
 - WAZER will then start to pierce through the Material. If this is the first time you are experiencing a Waterjet cut, this may be noticed as a sudden "burst-like" experience. For the next few seconds you may feel some Used Abrasive spray from the openings of WAZER during this operation. Additionally, used Abrasive will build up on top of your Material. Both of these are normal.
 - If you listen carefully, once the pierce is completed you will hear a distinct difference in noise where the water stream has now pierced through the material and rushing into the water tank, thereby starting your cut!
 - Within a couple seconds of completing its pierce the Nozzle will begin to move slowly, cutting out your part.
 - As the cut progresses WAZER will have a constant vibrating buzz while cutting along with a few ticking sounds at
 - The start and end of cut segment that come from the Pump Box. The Pump Box should emit a smooth hum – there should be no erratic sounds coming from the Pump Box or constant "ticking". WAZER will also generate noise from the Jet cutting the Material and creating turbulence in the Tank.
 - If you observe the Control Box, all four LEDs on the left side will be on, the top and bottom lights of the middle column will be on, the middle two LEDs of the middle column will be flashing. Lastly, some, if not all, of the LEDs on the right side will be on, depending on what state the WAZER is in.
- **Feed Rate Override:** Allows you to increase or decrease the speed of cut to compensate for changes during real-time cutting. This can be a great crutch to just get through a cut in the event that your rates were incorrectly set or your machines starts to tail cut, prevents you from having to go all the way back to Wam or immediately troubleshoot your machine.
- **Carefully watch the Cut:** If any unexpected behavior occurs, or if you are not sure what WAZER is doing, press Start/Stop to Pause the Cut and refer to the website resources section for more
- **Common First Cut Hangups:** If this is the first time you are running the machine it is possible a water leveling error may occur. This is simply your WAZER learning its water position. Therefore you can acknowledge the error message and continue cutting without performing any actions. However, if you haven't yet performed "Priming the Plumbing and Setting the Machine Water Level", please complete that prior to continuing.

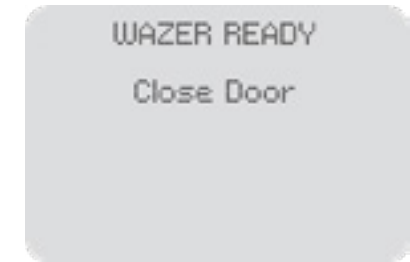

⚠WARNING Never open the Door while WAZER is running. Never leave WAZER unattended while it is running, this includes all power-on states including a pause state or the main menu.

A pressure gauge for the high pressure hydraulic system is located on the left-hand side of the Pump Box. It is recommended that you check this gauge periodically throughout the cut and also when debugging a cutting related issue. As a reference to the colors:

- If below the green area: You may experience partial cutting but it is safe to continue. This may be a sign that your inlet pressure is too low, your inlet water filters are clogged, or your pump unit may need to be refurbished.
- If in the yellow zone between cutting segments, this is expected and normal, proceed as usual. If in the yellow zone during the middle of a cut, pause the machine, cancel the cut, and contact WAZER support.
- If the needle is in the red zone, pause the machine, cancel the cut, and contact WAZER support.

When the pressure exceeds 4600psi/315MPa (red zone on gauge), the pressure relief valve inside the pump box will open and release the excess pressure. When this occurs a small amount of water is released which may be noticed as small drips in the bottom of the pump box. This should not occur under normal operation. If noticed during a cut segment, pause WAZER immediately, cancel the cut, and contact WAZER customer support.

1. Check, Pause or Cancel the Cut

While WAZER is running you can:

- **View the status of the Cut** on the Control Panel. This includes elapsed time and completion percentage.
- **Pause the Cut**
Pressing Start/Stop will pause the Cut. Water and Abrasive will stop flowing, and the Nozzle will hold its position. This will not happen instantaneously, because WAZER must perform the correct Shutdown.
- Once paused, you can either cancel the cut or continue the cut. Select the option you want and press okay to confirm your selection. If you choose to cancel, WAZER will immediately purge its line pressure (in the form of a burst of water from the nozzle). The nozzle will stay in the last position.

⚠WARNING **DO NOT** open the Door until you hear that the Jet has turned off and see that the Nozzle has stopped.

⚠WARNING **DO NOT** open the Door until you have canceled the Cut and the Control Panel returns to the Main Menu. This is required so that the high pressure in the hydraulic lines can be safely released. If for some reason this was not possible (ie. Emergency shutdown required or accidental reset of the machine), don't worry just do a High Pressure Purge from the WAZER controller Menu or start/cancel a cut.

If instantaneous stop function is necessary, push down the Emergency Stop Button located near the UI Screen. This will cut power to both Main Unit and Pump Box.

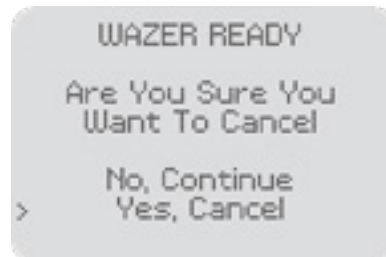
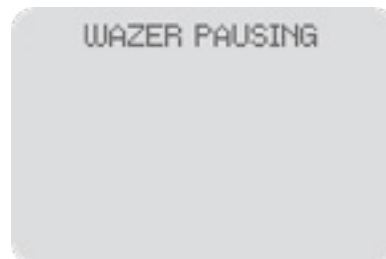
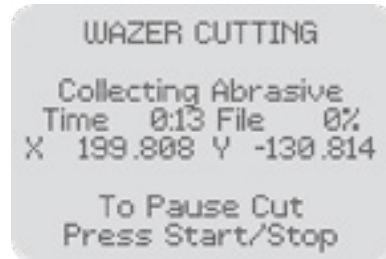

• Complete the Cut

The Control Panel will indicate that the Cut is completed. It is now safe to open the Door. Push the Nozzle aside and move the gantry out of the way by hand. Remove the fasteners securing the Materials.

• Cleaning WAZER

Once a Cut finishes, you will notice that the inside of WAZER is covered in Used Abrasive. If you are going to continue cutting with WAZER, there's no need to clean off this abrasive now. If you're done cutting for the day, leave the Door open and allow the Used Abrasive to dry. Once dry, it is easy to dust away the abrasive with a soft brush to clean WAZER.

⚠CAUTION

Bacteria can build up in the standing water of the Tank. Any injuries or cuts, even minor ones, should be treated with caution. If you have open wounds avoid contact with the water or wear gloves that do not expose you to the Tank water

Common Things To Be Mindful Of During Cutting

It will take you a few cuts and some time to get familiar with WAZER. To help start you off on the right foot we have accumulated a list of common failure modes and things to look out for.

⚠WARNING Follow all Safety Advisories when performing a Cut:

- ALWAYS wear eye protection.
- NEVER leave WAZER unattended while in operation.
- ALWAYS know how to quickly turn off water and power in the event of an emergency.

NOTICE Pay Attention!

It is important to monitor WAZER while it is cutting. Some issues may require intervention to avoid damaging WAZER or Material.

Pop-Ups:

Pop-Ups are when a section of material pops up above the original surface of the Material, dislodging itself from its original position as it is cut. An edge may come into contact with the Nozzle, resulting in the Gantry losing its position. This will cause a Failed Cut due to registration errors. Pop-Ups occur if you have not sufficiently connected the cut portions of your Design to the outer section that is fastened to the Cut Bed using the "Tab" feature in Wam (more on this feature in Section 6: Creating Cut Files). If you see a Pop-Up, press Start/Stop immediately and attempt to fix the problem before the gantry jams against it.

Abrasive Clogs:

Abrasive Clogs can sometimes occur on the Abrasive Hose, preventing Abrasive from flowing into the Nozzle. This will be easy to identify since WAZER will stop cutting through the Material. Instead, the Nozzle will spray water all over, and there will be a significant change in the sound of WAZER's operation. If there is an Abrasive Clog, press Start/Stop immediately. Refer to the website resources section for more information.

Leaks:

Despite WAZER being an enclosed system it is not completely sealed. You will inevitably find an occasional drip or some Used Abrasive outside of the WAZER. However, you should monitor for any abnormal drips, leaks or puddles. If you notice this, press Start/Stop immediately and trace where the leak originates. Refer to the website resources section for more information.

Expected potential drip areas on WAZER:

- When opening and closing the Door.
- Water may spray through the cracks between the Door and Hoops.
- There may be occasional drips around the Side Windows.

Solution After Leaks Detected:

If there is a leak or things get wet that likely shouldn't have, turn everything off, unplug power cords if they didn't get wet, wipe the leak, and turn everything off, unplug power cords if they didn't get wet, wipe the leak, and LET IT DRY overnight before seeing if anything was damaged and is still working. Water doesn't damage electronics, it's the combination of water with electricity that does, so letting them air dry lets you be sure that the next turn on won't destroy something.

Water Exiting Under the Abrasive Hopper: If you notice water leaking or spraying out of WAZER from underneath the Abrasive Hopper, press Start/Stop immediately as you have just experienced a "backflow". Refer to the online resources section for more information on how to resolve this.



Popup



Abrasive Clog

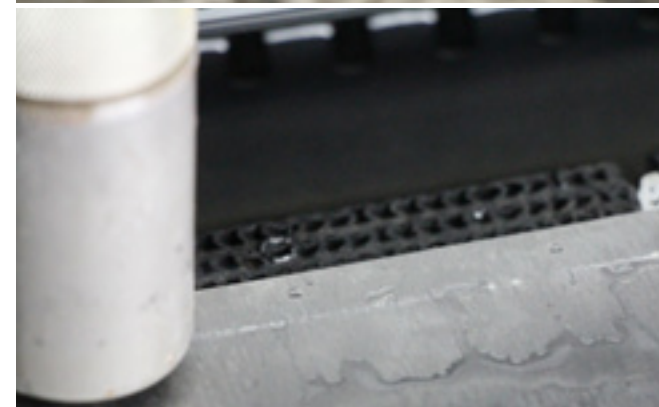

Abrasive Clog Identification



Abrasive Clog Identification

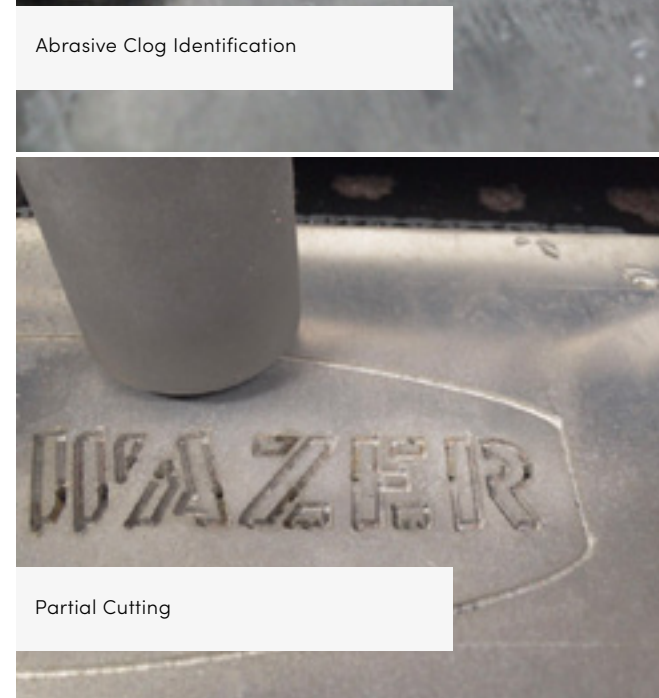

Partial Cutting

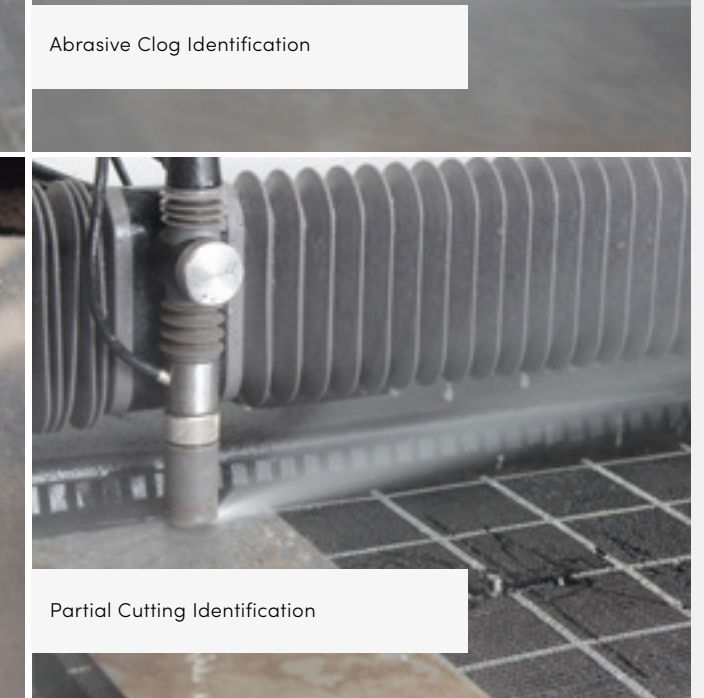

Partial Cutting Identification



Leak



Leak

Piercing sound:

Leaks: WAZER always starts every segment of a cut with a pierce. Before the water Jet can start the cutting motion, a hole must be pierced through the material. When the high-speed slurry coming out of the nozzle hits the work piece you will hear a very loud noise coming from the cutting area. However, as the water/slurry stream progresses through the material you will hear the pitch change and the volume of the noise. Once the work piece is pierced through, the high-speed slurry stream no longer bounces off the material surface and the volume of noise will significantly drop. At the same time, you will notice the sound of the high-pressure stream stirring up water in the main tank. This sudden change in loudness is the tale tell sign of successful pierce and indicates WAZER is ready to proceed with cutting motion. However, if no obvious change in either sound level or pitch takes place for a prolonged time, it likely means something is not right. If you experience this, pause the cut and refer to trouble shooting section to diagnosis the problem.

Abrasive usage:

Whenever the WAZER is cutting or piercing it is consuming abrasive. During this time the abrasive is sucked from the abrasive hopper up to the nozzle. During a cut you can verify that abrasive is flowing by observing the pile up of used abrasive around the nozzle. Another quick check while the cutting is running is to observe the abrasive level of the abrasive hopper gradually reduce. If you see any problem combined with partial or no cutting, please pause the cut and refer to the resources section for problem diagnosis.

Pressure fluctuation:

Due to various reasons, water supply at homes and commercial settings may suffer from temporary pressure inconsistency. As a result, this will effect the output pressure of the Pump Box and thereby influence your cut. Minor reductions of a few PSI (ie. <25psi) are not an issue unless the pressure drops below 35psi, in which case a failed cut is imminent. It is important to make sure that water hungry devices or fixtures aren't used during a cut on the WAZER. This failure could be the result of something as simple as turning on a faucet in an adjacent room. The water draw can cause a drop to the inlet pressure which can be below the lowest allowable for the WAZER. This can cause partial cutting or potentially a backflow. If pressure fluctuation is too frequent, contact local water supply authority for more information.

Partial cutting / tail cutting:

Partial Cutting means that the Jet is not cutting all the way through the Material. This is evident when the Jet exits horizontally (opposite the Nozzle's traverse direction) instead of downward into the Tank. If this happens, press Start/ Stop immediately. Refer to the website resources section for more information.

NOTICE Allowing your machine to partially cut puts a lot of stress on components that are not intended to be blasted with the abrasive stream and abrasive (ie. the side of the tank, windows, and water sealing surfaces like the bellows). Your machine components are designed to handle this for a few seconds every so often as it is inevitable that a tailcut happens every so often. However if you allow for cuts to proceed with tail cutting this will cause permanent damage to your machine.

Various error messages:

- **Add Water To Cut Bed Level:** This error indicates that the Water Level in the Tank is too low. Follow the instruction on the screen, or refer to the website resources section for more information. If this is your first time seeing it, it is okay to acknowledge it once and not do anything. The machine may take some time to settle its water level.
- **Check Drain Filter And Dump Hose:** This error indicates that WAZER is not draining properly, likely due to a clogged Drain Filter or an obstructed Water Drain Hose. Follow the instruction on the screen, or refer to the website resources section for more information. If this is your first time seeing it, it is okay to acknowledge it once and not do anything. The machine may take some time to settle its water level.
- **Fill Abrasive Hopper & Empty used abrasive:** This message indicates that the Abrasive Hopper is nearly empty. Refill the Abrasive Hopper and continue cutting.

- **Cut Failed Lower Tank Water To Cut Bed Level:** Something has gone wrong in the drain system and the tank has filled to the high water level safety switch. Typically this is just the drain filters refer to the web resources for troubleshooting information. Make sure the Main Unit is level.
- **Regenerate Cut File With the Latest Version of Wam:** To insure proper function of the WAZER it is important that both the firmware and the version of WAM used are the latest so they are compatible. This error occurs when the firmware version is significantly newer than the wam version used to generate the file.
- **Unexpected End of the Cut File. Check Setup & File:** This error will typically occur when something goes wrong with the transfer of the cut file to the controller. Typically the root cause is a corrupted SD card.

Used abrasive bucket not properly seated:

Used Abrasive buckets are designed to collect used abrasive from the tank bottom for easy cleaning. However, if they are not seated fully into their holders, collection streams will dispose used abrasive back into the tank bottom instead of the Used Abrasive Buckets. If you notice the Used Abrasive Bucket is not properly seated during cut, please pause the cut. Refer to the two techniques mentioned before to properly seat the two buckets.

Finishing

Cut Quality

Cut quality on WAZER is a function of the Cut Rate. A Fine Cut (slower Cut Rate) will result in a smoother surface along the edges of your Part, whereas a Coarse Cut (faster Cut Rate) will result in a rougher surface along the edges of your Part.

As a reference guide, the illustration provided shows approximately what to expect at three different levels of available Cut Quality. More on how to set the Cut Rate in Section 6: Creating Cut Files of this User Manual.

Remove the Tabs

At the end of a Cut, scrap pieces will still be connected to your part. This is necessary to keep the Part in place and to avoid Pop-Ups during the Cut.

Tab removal refers to the activity of removing your desired Part and the remainder of the scrap Material by breaking the small connections between them. To do this, wear protective gloves and use a blunt tool or set of pliers to bend the pieces until the Tabs break. We have included some basic tools like a set of small pliers, a file, and deburring tool in the black toolkit that came with your machine. These will aid you in cleaning up some of these cut imperfections.

If it is difficult to remove Tabs, we suggest you lightly Dremel the backside of the Tab. You can also slightly decrease your Tab size for that Material in the software (more on this in Section 6: Creating Cut Files).

Deburr your Part

Parts may be sharp immediately after cutting. It may be required to remove a sharp edge on the bottom side of the Part. We suggest using a deburring tool or file that is appropriate for the geometry and material.



Shutdown WAZER

Once you have completed your Cut, perform the following Shutdown procedure:

1. **NOTICE** Close the On/Off Valve
Turn the On/Off Valve to the "off" position.
2. **Turn WAZER Off**
WAZER has a single Power Switch located in the bottom-right corner. Flip this switch to turn WAZER off. Do not use the Emergency stop switch at the top of your machine as your main power switch.
3. **Empty the Used Abrasive**
We recommend that you remove the Used Abrasive Buckets from their retainers and place them up on the Cut Bed after every Cut. This allows them to fully drain their water into the Tank, which means you won't have to deal with water in your Used Abrasive disposal area. However, you may empty the Used Abrasive at any time, so this step isn't critical to perform during shutdown if you regularly do it upon startup.

CAUTION Bacteria can build up in the standing water of the Tank. Any injuries or cuts, even minor ones, should be treated with caution. If you have open wounds avoid contact with the water or wear gloves that do not expose you to the Tank water

4. **Leave the Door Open**
After a Cut, everything inside WAZER is wet. We suggest leaving the Door open so the internal surfaces can dry. This prevents tight areas from growing mold and allows you to brush away the Used Abrasive once it is dry. It is much more difficult to clean the Used Abrasive when it is wet.
5. **Perform a General Inspection**
It is always a good idea to inspect WAZER for leaks and abnormal wear:
 - Is there water around WAZER or Pump Box?
 - Are there any pieces of the Cut Bed that stick out, or are there pieces of cut Material lodged in it?
 - Are the Bellows sealed against the aluminum Gantry Blocks?
 - Are the rubber gaskets around the inside of the machine correctly seated around the machine (ie. back of the tank, edges of the door, back of the block that has the Cutting Head mounted to it).
 - Do any hose lines leading up to the cutting head have too much tension?

NOTICE The sooner you notice and fix a problem the better. Most importantly, you MUST remember you are dealing with water, which can result in things such as electrical shorts and water damage. Prevent a serious problem from occurring by paying attention to your WAZER.

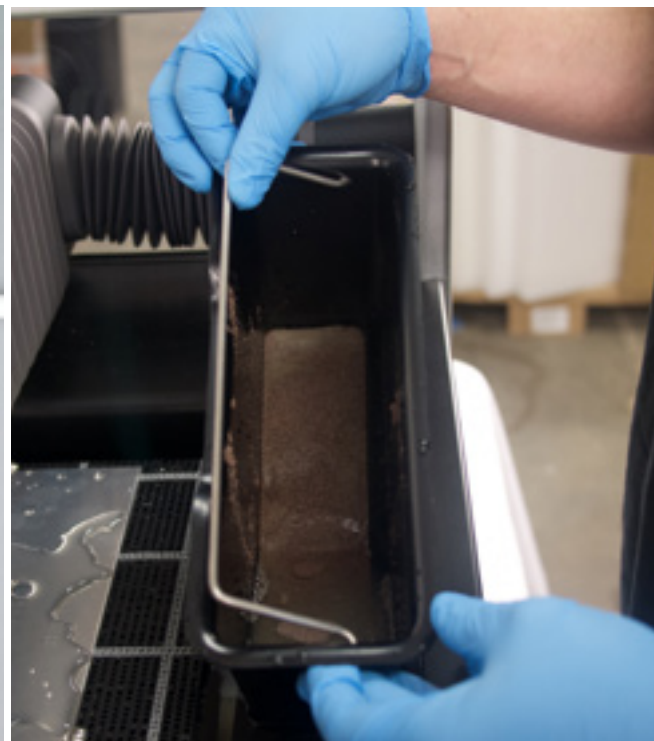

Maintenance Between Cuts

Please perform the following maintenance actions after every 4 hours of runtime. We have incorporated the important parts of this list within the checklist that is at the end of this section. We provide two copies of it in order to encourage you to post it near the location of your WAZER and ensure it is followed with every cut!

It is essential to perform these tasks routinely; more often will not harm your WAZER but performing them less often than every 4 hours of runtime can lead to decreased performance or more serious maintenance issues.

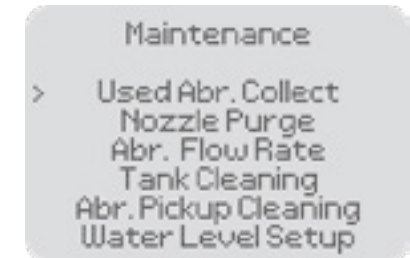

1. Run a Tank Cleaning Cycle

The Filtration System collects abrasive from the four corners of the Tank. However, some abrasive can still collect in the middle of the Tank or be biased towards one side or the other based on where the machine was cutting the most. To collect this abrasive, run the Tank Cleaning Cycle from the Setup & Maintenance menu of the Control Panel. For more information on using this mode reference Section 7: Maintenance. This procedure will help prevent any unwanted Abrasive Clogs of the Filtration System.

We encourage you to run a Tank Cleaning Cycle to collect the excess Used Abrasive after cuts and before turning off your WAZER for a few days. This will make sure the abrasive pickup ports are cleared and abrasive won't compact down on them, clogging the system up. Additionally, it is a good idea to run a tank cleaning cycle after your WAZER has been sitting for a set of days and before its next cut. This will loosen the excess abrasive at the bottom of your tank and in the collection ports, making the collection system more effective during cutting. This will help keep WAZER clean and will prevent you from needing to scoop Used Abrasive out of the Tank by hand.

If you notice that WAZER is not collecting Used Abrasive as quickly as it should, please perform the procedures listed in Section 7: Maintenance>Misc. Maintenance Procedures>Clearing the Filtration System and also Section 7: Maintenance>Misc. Maintenance Procedures>Tank Cleaning Cycle.

2. **NOTICE** Clean the Abrasive Hose End

The tip of the Abrasive Hose accumulates silt that can clog the line. Dunk the dry abrasive line 1 cm into the tank to loosen the silt and flick/shake it out to make sure no water is in the hose. Repeat this a few times before inserting the Abrasive Hose back into the Nozzle.

Make sure you insert the Abrasive Hose End far enough in so that both black O-rings are fully seated in the Nozzle. This seal is critical to the performance of WAZER. If you see excessive wear on the Hose End or O-rings, replace them as soon as possible. You will find a spare Hose End O-ring in the accessory bag.

3. Leveling the Cut Bed

- Follow the pre-cut check step to use the add-on tool to check the levelness of Cut Bed. In some occasion, worn Cut Bed may warp or deform after extended use.
- Make sure the Cut Bed is level before and after every cut help to ensure the cut quality.

4. General water seal inspection

Check if all bellow, gasket and o-rings are seated properly. If you see any water-proof mechanisms not seated as it should be, correct them before next cut.

5. Abrasive Accumulation

Brush away loose abrasive from door window, bellow and side of tank.

Accumulated used abrasive may block your direct sight to cut area, and delay your response if any failure happens. Maintain a clear view to cut area is vital in safe operation.

Scoop used abrasive underneath used abrasive buckets.

Piled up abrasive underneath Used Abrasive Buckets may cause the bucket not seated properly. Improperly seated buckets are incapable of collecting used abrasive effectively, thus create used abrasive pile up more in the tank bottom.

Make sure that your abrasive buckets are always properly seated. This may require you to push some of the abrasive out from under the bucket away or scoop it out.

6. **NOTICE** Short, Medium, and Long Term Maintenance To ensure safe and reliable operation, you MUST familiarize yourself with and perform the procedures in Maintenance > Preventative Maintenance. Further maintenance schedules (short, medium, and long term) are explained in this section.



WAZER

Cutting with WAZER Checklist

⚠WARNING NEVER skip any Startup or Shutdown steps. Failure to complete these steps could lead to injury and damage to WAZER and your property.

We suggest you take this page out of the User Manual and leave it near your WAZER.

1. Preparation

- Wear proper Personal Protective Equipment
- Open the On/Off Valve
- Fill the Tank
- Once dry, brush away used abrasive on door window, bellows, and side of tank
- Level the Cut Bed
- Check Water Drain Hose Location and Attachmen
- Check for Leaks
- Confirm all Electrical Connections (Check GFCI/PRCD functions)
- Check Position the Water Sensor Alarms
- Machine Power On

2. Cut Setup

- Insert the SD Card
- Turn on WAZER
- Select the File to Cut
- Follow the Control Panel Prompts
 - Lift the Nozzle
 - Home WAZER
 - Load Abrasive
 - Empty the Used Abrasive Buckets
 - Confirm the Water Supply is On

- Fasten the Material

- Set the Nozzle Height
- Check Cut Extents & Dry Run
- Shut door

3. Cutting

- Listen for the pierce through the material
- Check the pressure gauge reading
- Pay attention to the following
 - Pop-Ups
 - Abrasive Clogs
 - Partial Cutting
 - Leaks
 - Abnormal sounds

4. Shutdown

- Run Tank Cleaning Cycle
- Clean abrasive hose end, check condition of O-ring, and re-seat hose end into cutting head
- Close the On/Off Valve
- Turn WAZER Off
- Empty the Used Abrasive
- Leave the Door Open

WAZER

Cutting with WAZER Checklist

⚠WARNING NEVER skip any Startup or Shutdown steps. Failure to complete these steps could lead to injury and damage to WAZER and your property.

1. Preparation

- Wear proper Personal Protective Equipment
- Open the On/Off Valve
- Fill the Tank
- Once dry, brush away used abrasive on door window, bellows, and side of tank
- Level the Cut Bed
- Check Water Drain Hose Location and Attachment
- Check for Leaks
- Confirm all Electrical Connections (Check GFCI/PRCD functions)
- Check Position the Water Sensor Alarms
- Machine Power On

2. Cut Setup

- Insert the SD Card
- Turn on WAZER
- Select the File to Cut
- Follow the Control Panel Prompts
 - Lift the Nozzle
 - Home WAZER
 - Load Abrasive
 - Empty the Used Abrasive Buckets
 - Confirm the Water Supply is On

- Fasten the Material

- Set the Nozzle Height
- Check Cut Extents & Dry Run
- Shut door

3. Cutting

- Listen for the pierce through the material
- Check the pressure gauge reading
- Pay attention to the following
 - Pop-Ups
 - Abrasive Clogs
 - Partial Cutting
 - Leaks
 - Abnormal sounds

4. Shutdown

- Run Tank Cleaning Cycle
- Clean abrasive hose end, check condition of O-ring, and re-seat hose end into cutting head
- Close the On/Off Valve
- Turn WAZER Off
- Empty the Used Abrasive
- Leave the Door Open

Creating Cut Files

SECTION

6

The Ins and Outs of Wam

Wam is the software that turns your Design into a Cut File for WAZER; it manages important aspects of the Cut, like the Cute Rate and when to engage or disengage Cuts.

- Design Software
- Terms of Service and Privacy Policy
- Wam Overview
- Wam Setup
- How to Use Wam
- Wam Settings
- Cut File Steps
- Using the Material Library

Design Software

The first step to using Wam is to design your parts with one of the many vector design programs available today. Wam will work with any software capable of saving your Design as a .dxf or .svg file. These are universal 2D file formats that many programs support.

It is important to understand that Wam is not a design platform; there are a variety of different design software options that can translate your ideas and paper sketches into digital Designs. These programs vary in complexity and cater to a variety of different industries and applications; they also vary in cost and have different learning curves.

Choosing design software is a personal decision based on your needs, industry, and technical abilities. If you are just starting out with two-dimensional design, we suggest starting with a simple 2D option such as LibreCAD or QCAD. If you have some digital design experience you may want to use something like Inkscape. It may be a good idea to reach out to others in your industry to see what they are using and if it would be appropriate for your level of experience. If you are still uncertain as to what programs to use, please reach out to us at support@wazer.com and we'll be happy to help.

At WAZER we use a variety of software platforms across the team. Our engineering and technical team use AutoCAD, Onshape, Solidworks, and Pro-Engineer. Our business and design team use Inkscape and Adobe Illustrator. If you visit our website resources you will find export guides and information for some of the most popular design software programs such as Illustrator, Solidworks, Fusion360, and Inkscape.

Terms of Service and Privacy Policy

Please read the "Term of Service" and "Privacy Policy" on WAZER.com for more information

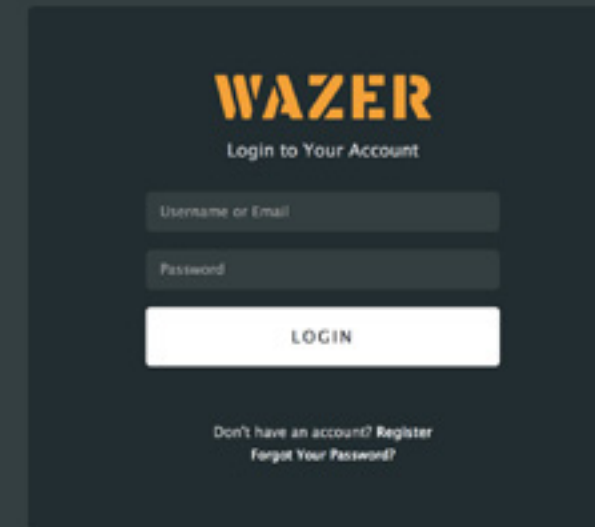
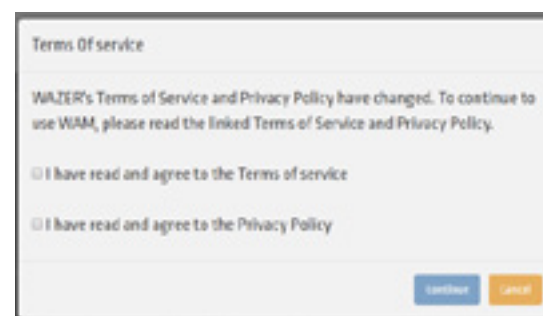

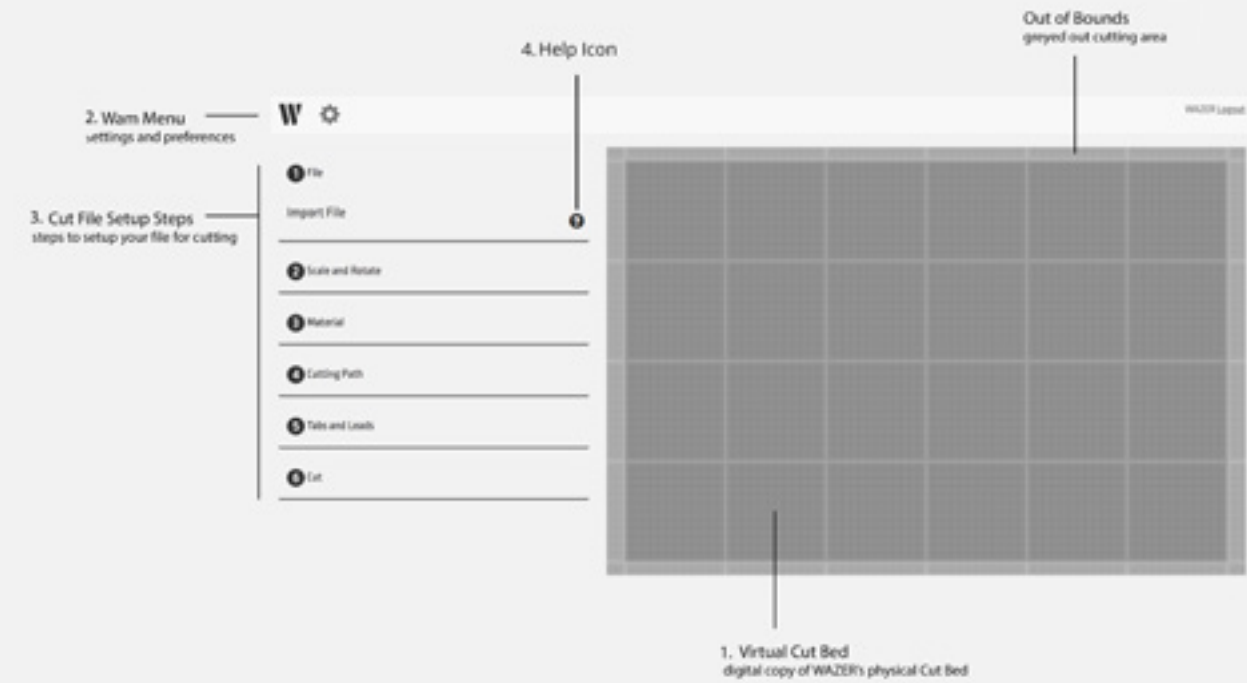
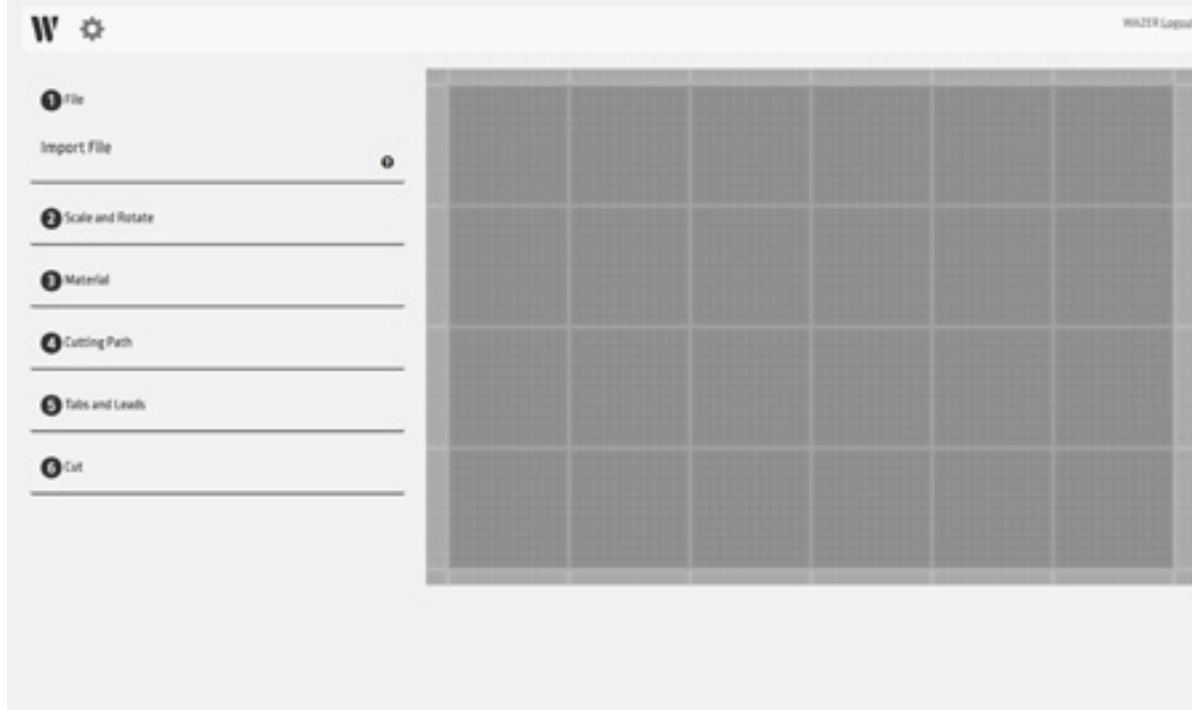

Wam Overview ▶ VIDEO

Wam is browser based. You can access it at wam.wazer.com.

After logging in, you will import the Design to be cut. After setting your Cut Parameters, Wam will generate a unique Cut File which you will transfer to WAZER. This Cut File will contain all the information WAZER needs to cut the Design in your chosen Material.

Despite Wam being browser based all of the design file processing is done locally on your computer. Often there is a misconception that web based software means data is being sent and processed on servers somewhere on the internet. This is extremely far from the truth and by using Wam your design files are never sent to WAZER servers or across the internet... period. As some additional insight on the matter, WAZER uses a browser based system for the following three reasons:

- Provide you free of charge updates to the software seamlessly upon login.
- Free you of software installation needs and PC/Mac compatibility issues.
- Collect information on the parameters that were chosen for a cut file so we can continue to provide meaningful updates on features and options that are actually being used.

Wam Setup

Registration

You'll need to register before using Wam for the first time.

- **Go to:** <https://wam.wazer.com> and select "register".
- Use WAZER's software serial number to register your account and gain full access to the Wam feature set. The software serial number is located on the first page of your user manual that shipped with your Wazer.
- Acknowledge you have read "Terms of Services" and "Privacy Policy" by clicking the adjacent box.

NOTE: Some users have reported trouble with registering their serial number later because of a block symbol on the Submit Serial Number button. Once you have typed in your number, either click outside the text box or press Enter to validate the number, then the button will activate and allow you to finish registering.

Logging In

- Go to: <https://wam.wazer.com>.
- Log in using your registered user name and password (case sensitive).
- You will remain logged in for 24 hours.

How to Use Wam

User Interface

At the highest level, you can view Wam as having four areas

1. **Virtual Cut Bed:** This area represents the WAZER Cut Bed. This allows you to arrange various Designs to be cut, exactly as they will be cut on WAZER's Cut Bed.
2. **Wam Menu:**
 - Start a new Wam setup by clicking on the **W** icon.
 - Select the options menu by clicking on the **⚙️** icon to change user account settings, preferences, and your personal WAZER settings.
3. **Cut File Section:** Use these six expandable Sections to configure the Cut on WAZER.
4. **Help Icons:** Next to each of the tabs you will notice a question mark **?** icon. Clicking these icons at any point will explain how to use that tab to effectively setup your design for cutting on the WAZER.

The Virtual Cut Bed

- **Arrange Cut Groups for cutting.** Left-click on the desired Cut Group and drag into place.
- **Select multiple Cut Groups at once:**
 - Apply the same settings to multiple Cut Groups.
 - Hold the CNTRL or SHIFT key, and select multiple Cut Groups.
 - The Bounding Box indicates selected Cut Groups.
 - Move the Cut Groups as a group into the desired position.

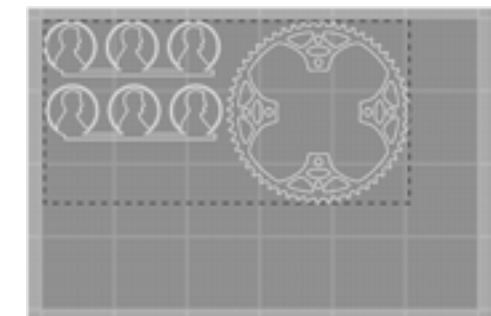

Wam Settings

By clicking on the  icon you will be brought into a two-Tab pop-up menu:

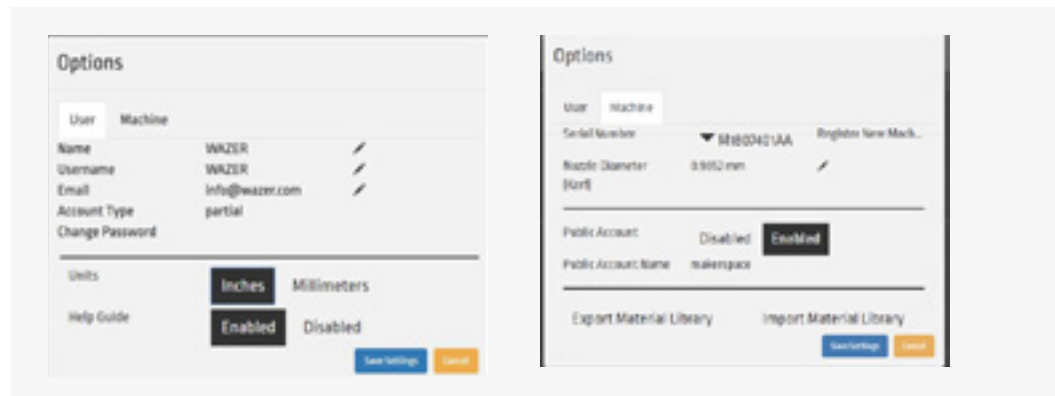

1. User Tab
2. Account Preferences, including:
 - Name
 - Username
 - Email
 - Account Type
 - **Partial/Demo Account** - When account is not registered to a valid WAZER with a Serial Number. Some Wam functionality will not be available to the user.
 - **Full/Registered Account** - When account is registered to a valid WAZER. All Wam functionality is available to the user. For every machine purchase you have a software license serial number. Registering a software account with this serial number enables that account to be a full registered account. Each one of these serial numbers can be used to register three accounts, so be mindful of who you give this serial number to. If your situation requires more accounts, please contact WAZER customer service.
 - **Public Account** - When account is registered to a valid WAZER. All Wam functionality is available to the user besides editing user/machine options and adding materials. Creating one of these accounts can be done by a full registered account holder of a machine.
 - Units - Specify the desired units
 - Help Guide - Either shows or hides the help icons at every setup step
3. Machine Tab Serial Number - This is a list of registered WAZER machines your account is linked to. Entering additional valid Software serial numbers will register additional machines to your account
 - **Default Jet Diameter** - This is the diameter of the Jet, otherwise known as the Kerf.
 - **Export Material Library** - As a registered Wam account holder you can save custom Materials to your account. You can easily export and import these Materials if you would like to share these settings with others.
 - **Public Account** - As a registered Wam account holder you can enable/disable a public access account for each of your machines. We have found that this may be a very useful tool for shared workspaces in particular, as you can share this public account login credentials with trained users of the machine, but at the same time controlling clutter in your material database or unwanted machine settings getting changed.

Cut File Steps

Step 1: Import File

Import File Compatibilities:

- **.dxf** - 2D file type that most engineering and design software will export.
 - The .dxf library supports arcs, circles, ellipses, lines, polylines, and splines.
 - All text must be converted to vector paths.
 - .dxf files do not include units - Wam tries to infer the correct units, but if it cannot, the part will default to inches.
- **.svg** - 2D Vector file that most design software will export.
 - Ensure that the output format for files is set to Plain SVG.
 - All shapes and objects should be simplified as paths.
 - Make sure the document units are set to physical units and not pixels.
 - Pictures and bitmaps will be ignored.

Import File Checklist:

- Convert all desired cut edges from objects to path.
- Convert all text to vector paths.
- Check for gaps.
 - If path fragments are 0.0010 inches apart or less, Wam will merge the fragments into a single path.
 - If a path start and path end are less than 0.0020 inches apart, Wam will merge the points and treat the path as closed.
 - Unconnected line segments less than 0.0001 inch long are deleted.
- Join and trim paths if necessary.
- Check for overlapping segments.
 - Overlapping Cut Groups may not be visible but may cause issues.
- Check for dangling or default Cut Groups.

It is possible to import multiple Designs, or the same Design multiple times in one Cut File Manage these Designs by using the +, -, and X Icons.

Cut Groups

Wam takes every Design and divides it into Cut Groups. A Cut Group includes all elements contained within a closed curve. The easiest way to understand this is to imagine a Design consisting of two concentric circles. These circles will be imported as one Cut Group, where the two circles are locked in reference to one another.

Split

It is also possible to upload multiple independent curves outside of a closed curve from a single .dxf or .svg file. When these curves import they will maintain their positions and groupings, and they can be moved about the Virtual Cut Bed as a group. If you would like to manipulate each curve independently, select the Split option in the File menu. This will break any curves not contained within a closed curve into independent Cut Groups that can be manipulated independently.

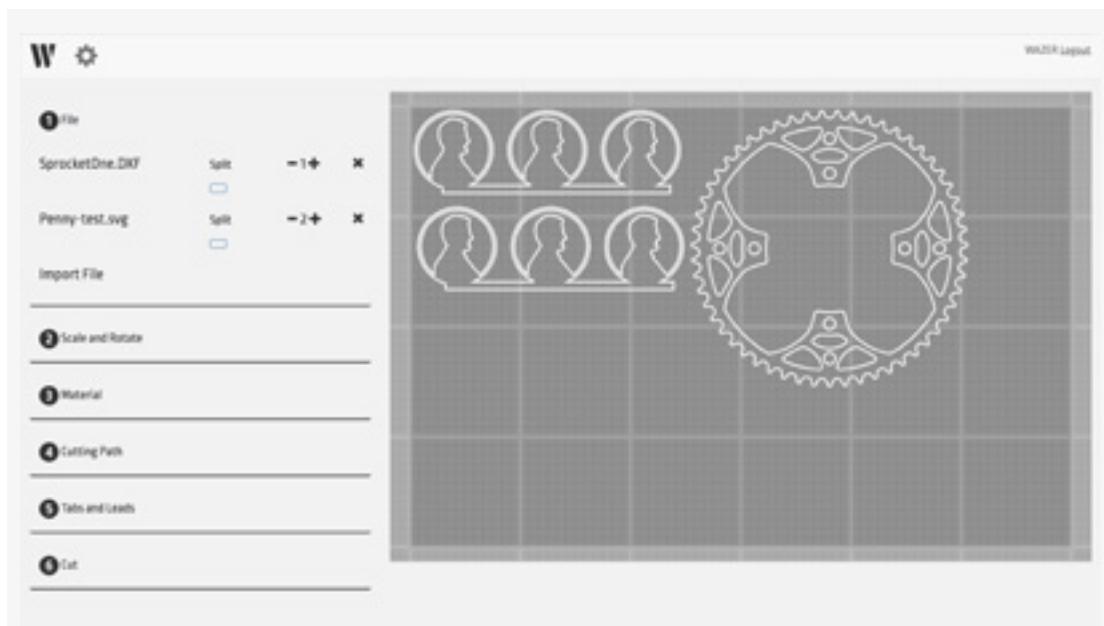

Inserting Multiple Parts and Instances of a Part

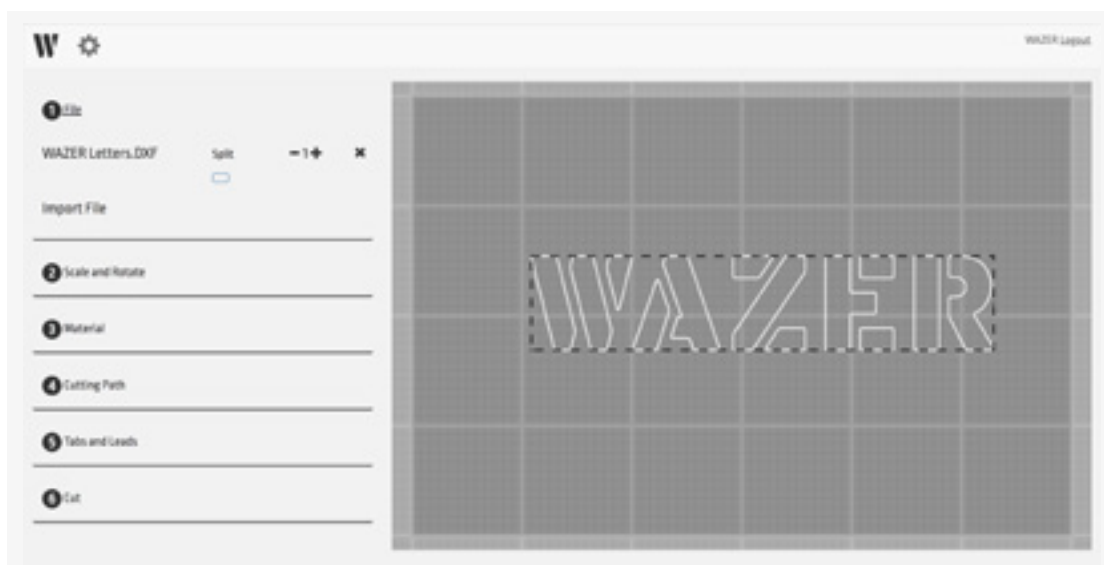

A Part with Multiple Contours is Treated as a Single Group

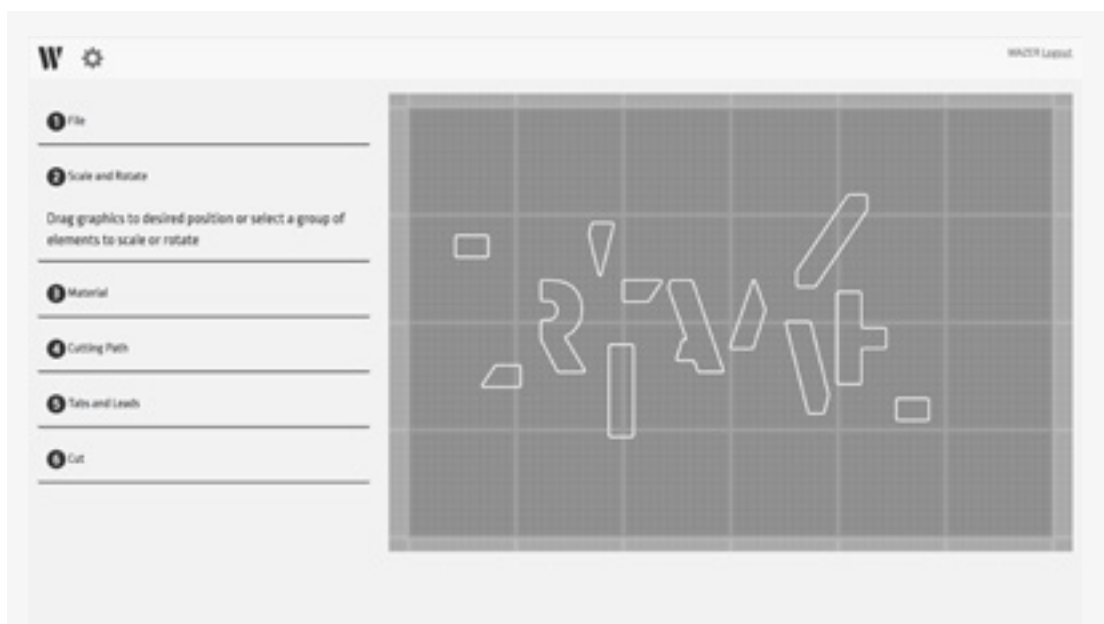

Results of Enabling "Split" for an Imported Part

Step 2: Scale and Rotate

Wam allows you to manipulate individual Cut Groups within the Virtual Cut Bed:

- **Rotation** – sometimes, if you want to nest as many cut groups as possible into a single cut file it can be helpful to rotate a cut group.
- **Adjust Scale** – for many applications, you will require your Cuts to be sized precisely. Some programs will Scale your Design in unexpected ways when exporting, so you will need to rescale your Design back to the intended size.

There are two methods to re-scale your imported Cut Groups:

- **Scale** - specify a scaling factor into the field to Scale the selected Cut Group(s) to size
- **Width/Height** - specify the intended major extent of the imported Cut Group (width or height) to Scale the entire Cut Group proportionally.

Location of vector group

- This feature update allows you to accurately position the cut path on the virtual cut bed.
- Use this feature to position the top-left point of the cut in relation to the bed origin (Top left of the bed) by entering the distance from that point in selected dimensions denoted by X position and Y position (See image below). This Feature works on one path at a time and is disabled during multi-selection.

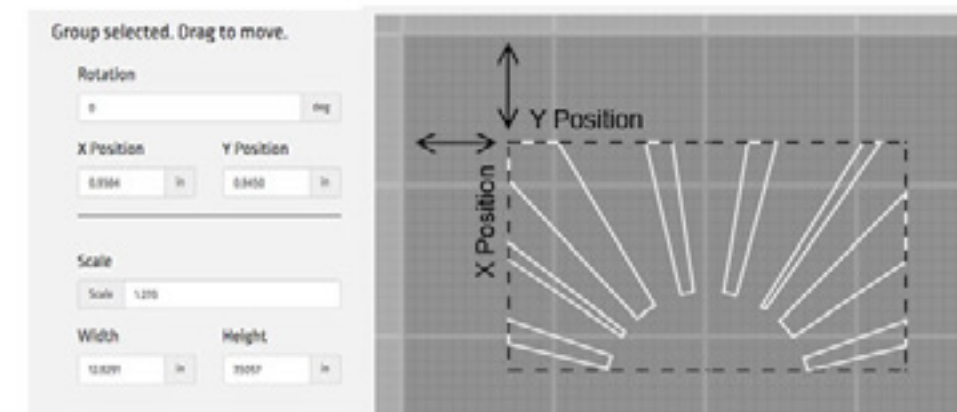

Step 3: Material Selection

WAZER needs to know the Cut Rate, or how fast it can cut, for your Material. Rather than relying on the user to calculate and enter this directly for every Cut, we have created a Material Library that holds all this information. You can simply specify your Material and thickness from the available selections, and Wam will set the correct Cut Rate.

When you log into Wam, the software will automatically load the most recent Material Library for you to select from. We will constantly be expanding this Material Library.

There may be some instances where a Material is not in the Material Library yet. If this is the case, you will have to manually Add Material, which is done easily through the Add Material menu (more on this later).

The organization of Materials is done by Material Type (i.e. metal, plastic, etc.), and then by specific Material (i.e. aluminum, stainless steel, etc.), and finally Material Thickness (i.e. 1.0mm, 1/16", etc.).

Default Material entries are indicated by a **W** icon, while your personal Material entries are indicated by a **U** icon.

WAZER currently only supports the selection of one Material per Cut.

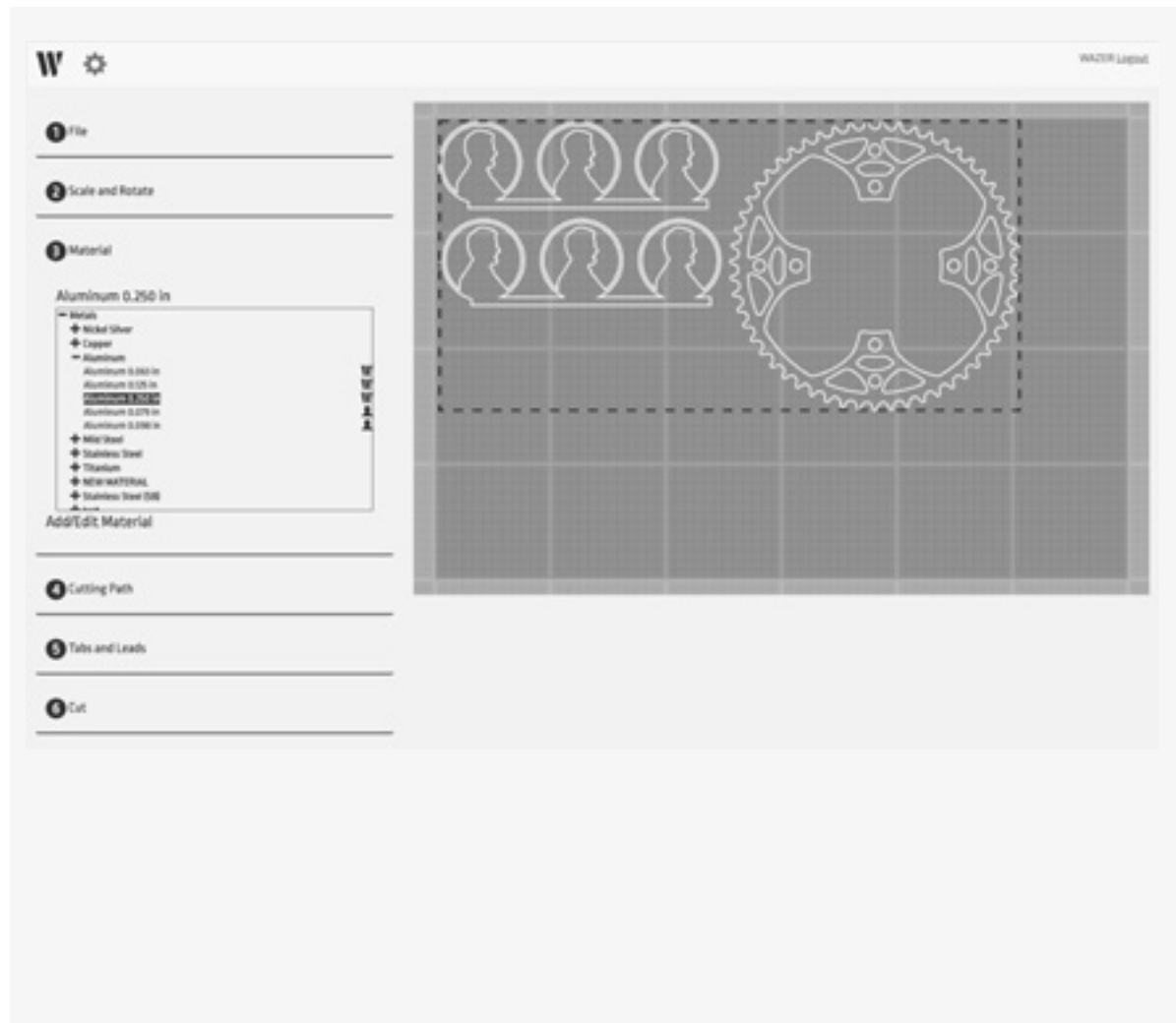
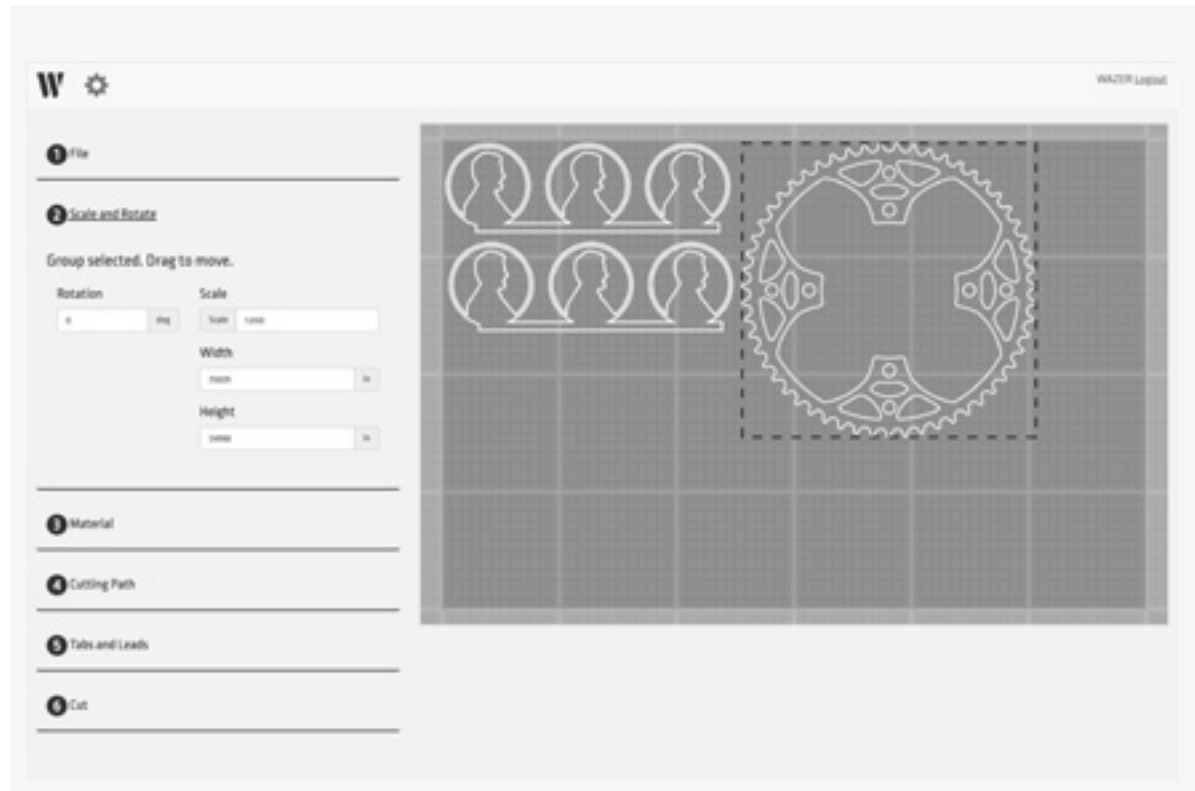

Step 4: Cutting Path

When a Design is imported into Wam it is simply a set of curves. These curves are shown in white.

To cut your parts properly, WAZER needs to know which side of the curve to Cut. As a result, the Cut Path needs to be specified as either Outside or Inside.

Once you have made a selection, a green Cut Path appears around or within the white part geometry. **This green line indicates the actual path of the WAZER. You can use it to check if your Design will be Cut correctly.**

It should be noted that there may be instances where you want to cut directly on the Cut Path. You can specify this using the Centerline option. In this case, you will notice that the green Cut Path completely covers the white geometry.

To aid in quick setup and accurate Outside and Inside Cut Paths, the software automatically defaults the offset value based on the Jet size (you can change the default in the Wam options).

There may be instances where you desire an additional offset to make your Part slightly smaller or slightly larger. To do this quickly, change the preloaded offset by the amount you would like to oversize or undersize your Cut.

Step 5: Tabs and Leads

A Tab is small connection point between your Part and the Material from which it is being Cut, designed to keep your Part in place for the duration of the Cut. Tabs help to increase overall Accuracy and prevent Pop-Ups, which can cause the WAZER to jam and ruin your Cut.

Wam automatically defaults to incorporating Tabs in default locations of each Cut Path. The location and size are designated on the Cut Group with a yellow indicator.

The default settings are that every Cut Path receives a single Tab of a size based on the Material. This will likely be sufficient for most Cuts and will seldom need to be changed. However, you should always review the default locations, in case they will cause problems with your Design.

If you need to make changes, select Manual Tab Placement and move the problem Tabs by left clicking and dragging them. You can also add and remove Tabs by left clicking. Additionally, there may be use cases where you cannot afford to place any Tabs, as a result you may want to select No Tabs. This is highly discouraged, however, because it greatly increases the risk of poor or failed Cuts.

A Lead refers to the distance that WAZER will be cutting away from the Cut Path. This is done to make sure that the oversized Pierce at the start of a Cut doesn't remove any excess material on your Part. The Lead's location and size are designated on the Virtual Cut Bed with a blue indicator.

NOTICE

When considering using No Tabs on a Cut, make sure you can afford a failure. There is a high likelihood that these parts will come loose, resulting in them either falling into the Tank or jamming the Nozzle.

Step 6: Finalize Cut

The last required selection in Wam is the Cut Quality. Cut Rate and Cut Quality have an inverse relationship; a faster Cut leads to lower quality, and better quality requires a slower Cut.

Once you have selected Cut Quality, you can specify a file name and select the Generate Job File Button to export the final Cut File. You can now move this Cut File to an SD Card and then insert the SD Card into WAZER to begin the Cut.

- **Show stock size in the last tab** - This feature displays Raw material size required for the cut in the cut section of WAM and helps you know the exact size of the raw material required based on the current layout on the virtual bed. Multiple cuts on the virtual bed are also considered while calculating the final raw material size.

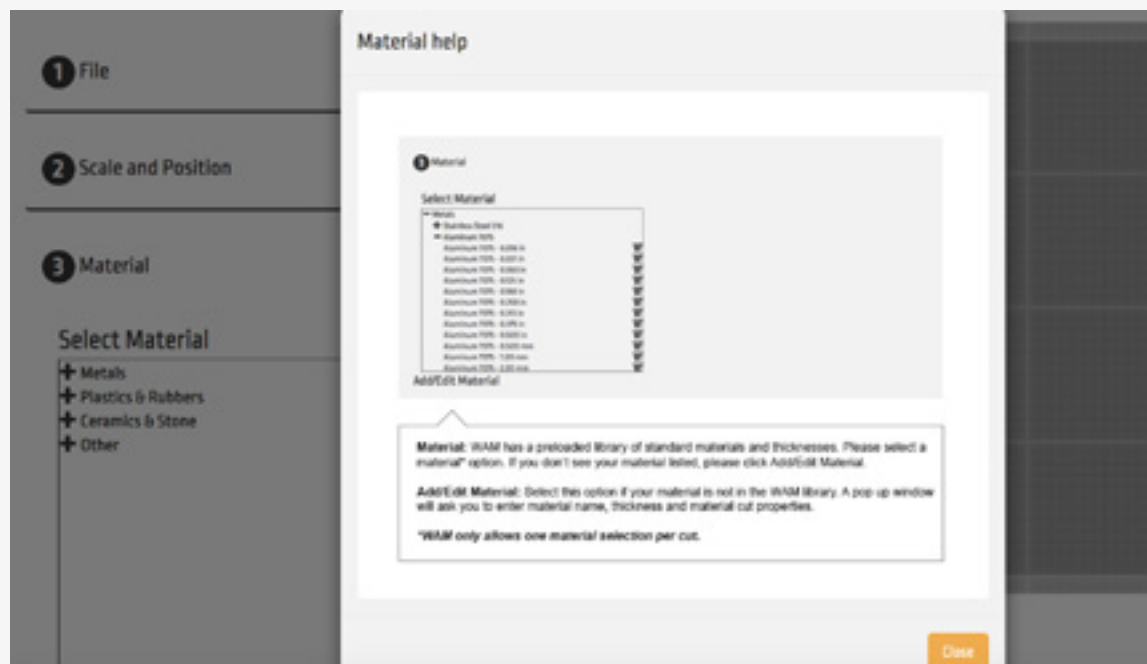
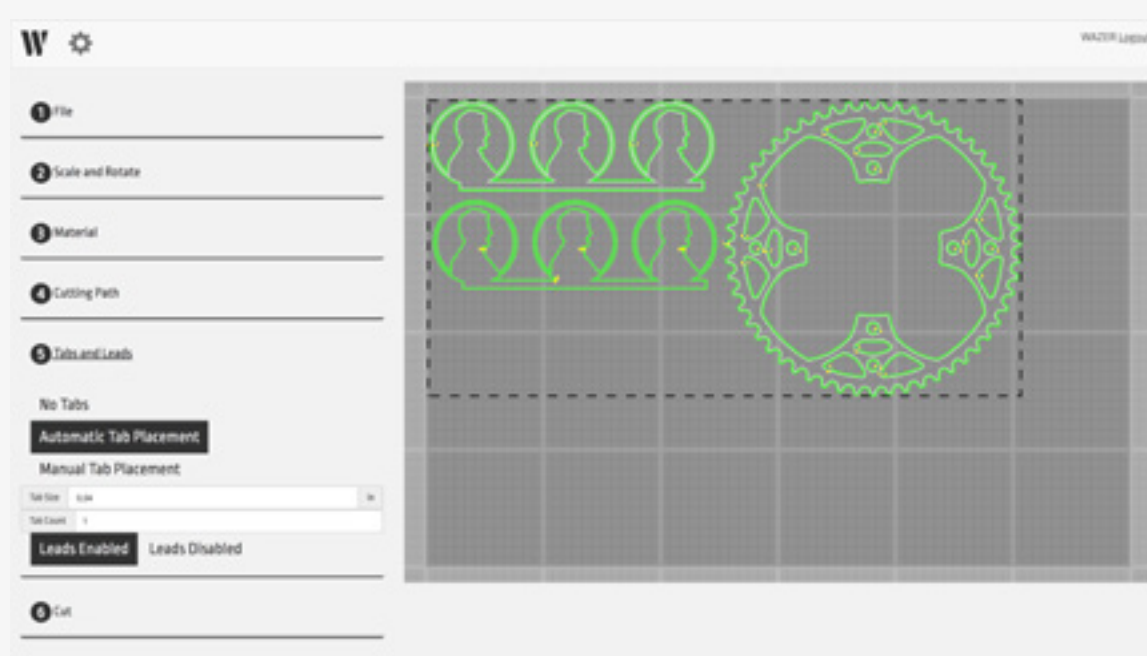
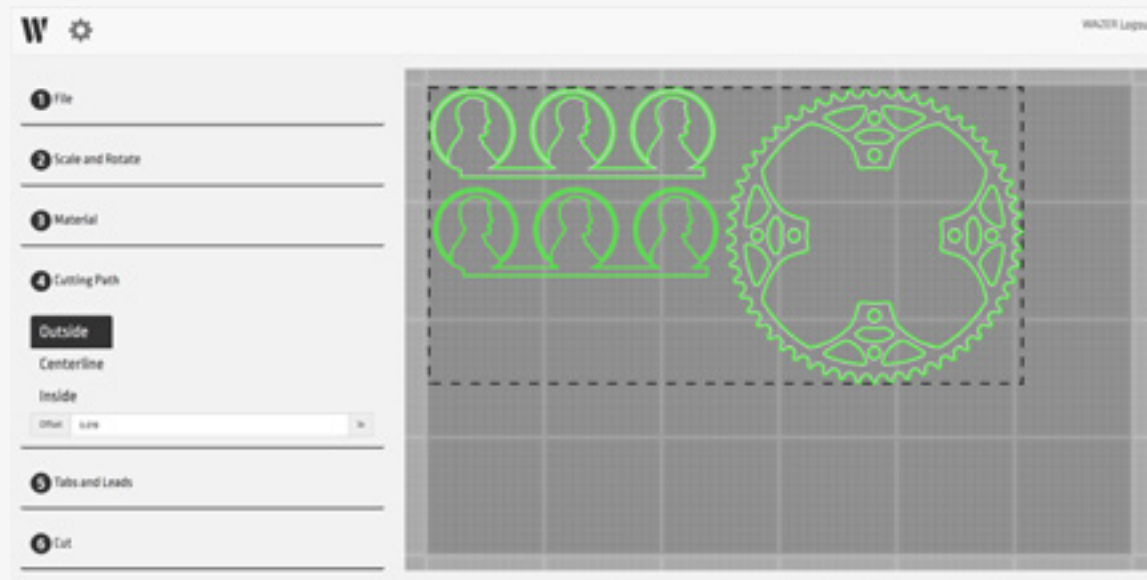

Using the Material Library

Within the Material Section, you will see an Add/Edit Material Button. Selecting it will bring up a menu allowing you to view your Material Library and create entries for new Materials. The left side of this menu shows the entire Material Library, while the right side of the menu shows the specifications of each entry.

WAZER Material Library

The Material Library contains default entries for the most popular Materials and sizes. These Materials will automatically be updated every time you log into Wam and will be indicated by a **W** Icon. You will not be able to edit or change these Material Library entries.

Adding and Editing Material Library Entries

There may be times where the Material Library doesn't have the Material you are looking to Cut; in these cases, you'll need to add a custom Material. When you add a new Material, it will be saved to your Account and all other registered users to your WAZER will be able to access it. You will see a small **W** Icon next to custom entries.

- **Adding New Materials:** Select the "New" button on the bottom of the menu and fill in the fields for the Material. You do not need to fill in all fields. It is sufficient to fill in only one Cut Rate before saving and using the Material.
- **Editing/Deleting Materials:** You can always come back and edit/delete a Material you have created by clicking on the custom Material in the Material Library, editing the fields desired, and saving the Material. (Please note that editing/deleting is only available for custom Materials; default Materials cannot be edited.)

Material Entry:

- **Material Type** – This field is the highest level organizational structure of your Material Library. The categories within this dropdown are designated by WAZER and cannot be edited or added to.
- **Material Name** – This field refers to the particular Material that falls under the Material Type. You can create as many new Material Names as you desire (i.e. composition and number designator).
- **Material Thickness** – This field refers to the thickness of the Material, which can be entered in mm or in.
- **Cut Rate** – Cut Rate is designated in three different levels.
 - **Coarse** – This refers to a rate that gives you the fastest Cut Rate. The Material will barely be cut all the way through, leaving a rough edge, especially towards the backside of the Material.
 - **Medium** – This refers to a rate that provides a compromise between Cut Rate and quality. With this Cut Rate, a smooth edge can be expected with minor visible striations.
 - **Fine** – This refers to a rate that gives you the highest quality (and takes the longest amount of time). With this Cut Rate, individual striations are not visible, resulting in an almost sandblasted edge finish.

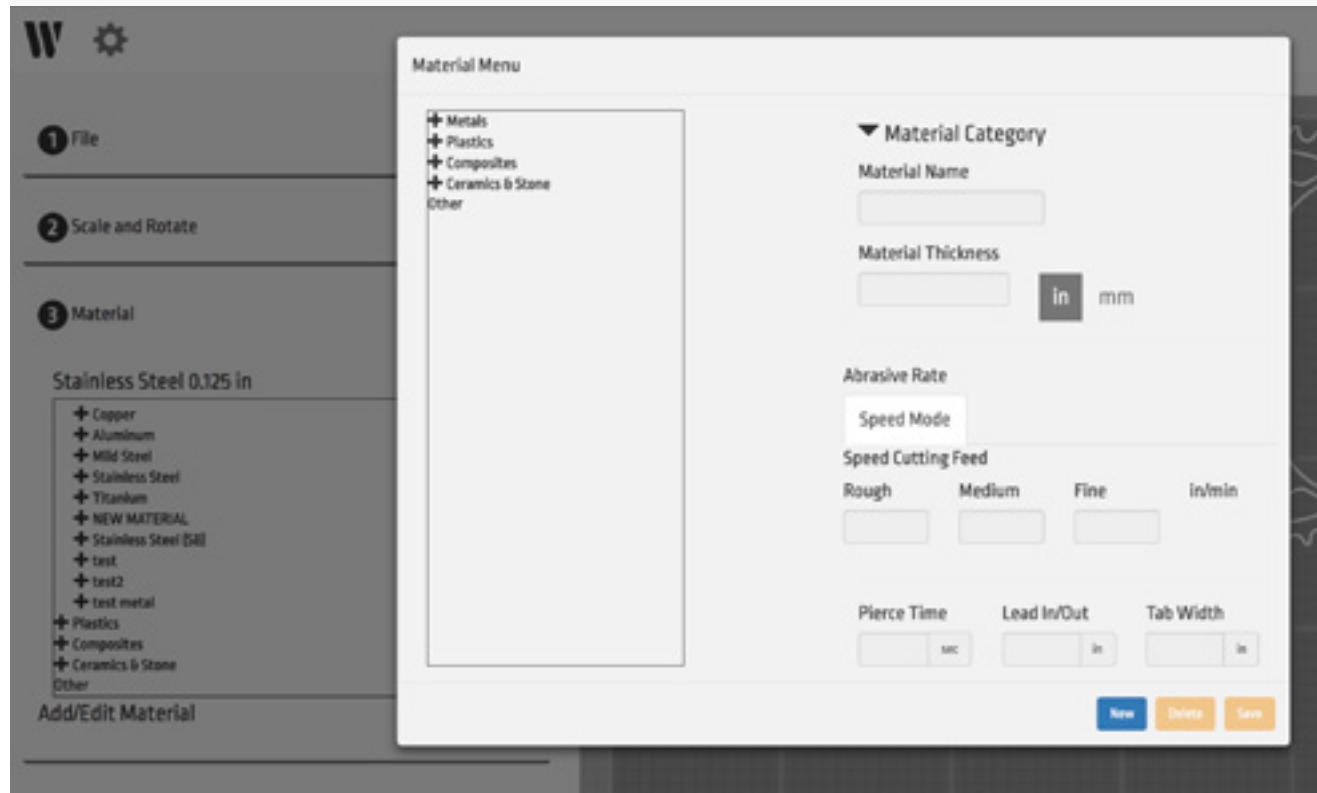

- **Pierce Time** – This field refers to the amount of time the WAZER will sit in a single position at the start of a Cut. WAZER needs to punch through the Material before it starts to follow your Cut Path. If the Nozzle starts to move before the Material is Pierced through, you should increase the Pierce Time. However, if the Nozzle doesn't move for a number of seconds after it has already Pierced through the Material, you should decrease the Pierce Time. The point at which WAZER has punched through the Material is both audible and visible – you will notice a change in sound and see air bubbles in the Tank once the Jet has Pierced the Material.
- **Lead** – This field refers to the distance away from the intended Cut Path where the cutting should start. Even though the Jet coming out of the Nozzle is consistent, the Pierce Hole will be larger than the Kerf. You therefore want to Pierce away from the Cut Path and then Lead into it. Additionally, this is a good parameter to modify for Materials that chip easily or are not homogeneous. This will vary between Materials and Material Thicknesses.
- **Tab Size** – This field refers to the distance that will be left uncut on a Cut Path to hold your Part in place. If it is difficult to break the individual pieces apart after cutting them, you should decrease this parameter. If the Tabs are breaking before the Cut completes, you should increase this parameter.

Maintenance

General upkeep of WAZER.

Like any machine, WAZER will require maintenance for proper operation. Please familiarize yourself with this section so you will know how to keep WAZER in optimal condition.

Maintenance Safety Precautions

⚠WARNING If WAZER was shut down or turned off before completing a cut, the system is still under high pressure. To release the high pressure perform a Nozzle Purge by navigating on the WAZER Control Panel to Setup & Maintenance > Maintenance > Nozzle Purge.

Before servicing WAZER always:

- Purge the high pressure by properly ending/completing a cut or performing a Nozzle Purge from the maintenance menu.
- Turn off or close the On/Off Valve or water supply to the machine.
- Turn off WAZER and disconnect AC power from WAZER and the Pump Box.
- Visually inspect both AC power cables. If damaged or worn, contact WAZER customer service immediately. DO NOT attempt to change or replace un-authorized power cables on your own
- Never remove the cover of the Pump Box while it is plugged in.
- Visually inspect High Pressure Hose and all plumbing coming in and going out from WAZER. Replace any low pressure hose if found damaged or worn; contact WAZER Customer service for replace if High pressure found worn and wire layer exposed.
- Please do a input check and GFCI/PRCD check as described before, after WAZER is maintained, repaired, upgrade or modified.

Machine Maintenance and Setup Menu

After a few cuts, you are very familiar with the cutting menu. Now it is time to familiar yourself with the menus that are built into the Maintenance & Setup menu on your WAZER.

Maintenance

Used Abr. Collect: This function turns on the Low Pressure system of WAZER to collect Used Abrasive. To fully utilize this mode use it in conjunction with the procedure outlined in Maintenance>Misc. Procedures>Clearing the Filtration System.

Nozzle Purge: This function turns on the High pressure system of WAZER. This can be used to purge pressure from the High Pressure lines when the water is turned off. It can also be used to observe the water stream for debugging. Follow the instruction shown on UI screen.

Abr. Flow Rate: This function turns on the abrasive system for a pre-set duration to help the user measure the abrasive flow rate. Refer to Maintenance section for more information on how to use this mode to calibrate and troubleshoot your WAZER.

Tank Cleaning: This function engages the High Pressure and Gantry systems to strategically stir used abrasive sediment at the bottom of your tank. It will also, and turn on Low pressure system to collect used abrasive from tank bottom. Follow the instruction shown on UI screen.

Abr. Pickup Cleaning: This function engages the High pressure and Gantry system to stir up used abrasive sediment localized around the 4 abrasive pickup filters located at the bottom of your tank. It also turns on the low pressure system to collect used abrasive. Follow the instruction shown on UI screen.

Water Level Setup: This function engages the High Pressure system and low pressure dump system to rise/lower water level to be within operational range. Follow the instruction shown on UI screen.

Input/output check

Input

Door Switch: Follow the instructions on the screen to ensure the proper function of door switches interlock system.

Water Level Sensor: Follow the instructions on the screen to ensure the proper function of water level sensor.

Service Sensor: Follow the instructions on the screen to ensure the proper function of the high level water sensor.

SD card: Follow the instructions on the screen to ensure SD card is ready to download cut tile.

Limit Switch: Follow the instruction on the screen to ensure the proper function of limit switches for your X and Y axis.

Output

LP Pump: This function engages the Low Pressure Pump for a short time. You may hear a light humming noise as well as see water being circulated in your tank.

Dump Valve: This function engages the Dump valve for a short time. You may hear a clicking sound being emitted from the Right Side Cavity area, once to open the valve and once to close it.

Vibration Motors: This function engages vibration motors for a short time. You can discern a constant buzzing sound from the Abrasive Hopper.

Abrasive Valve: This function engages the Abrasive Valve for a short time. You may hear a clicking sound being emitted from the Right Side Cavity area, once to open the valve and once to close it.

HP Valve: This function engages the High Pressure Valve for a short time. You may hear a soft click sound from the Right side cavity. If High pressure plumbing retains water pressure at this moment, this function will clear the residual pressure from High pressure lines.

HP Pump: This function engages the pump box for a short time. You may hear AC motor running in the Pump Box.

Jog: This feature enables you to move the nozzle to any point on the Cut Bed by manually controlling the buttons on control pad.

Cut Rate Testing

The WAZER will cut a series of arcs at increasing speeds to help you determine the cutting parameters for a new material.

General Cut: Run this cut when you have no idea how fast the WAZER should cut your material. This test will use the most material and have the least fine resolution.

Fast Cut: Run this when you know that your material should cut on the faster side.

Medium Cut: Run this when you know that your material should cut in the middle of our range.

Slow Cut: Run this when you know that your material is going to be slow, typical for materials on the thicker or harder side.

Firmware version

This feature displays the current firmware version installed in the WAZER control unit.

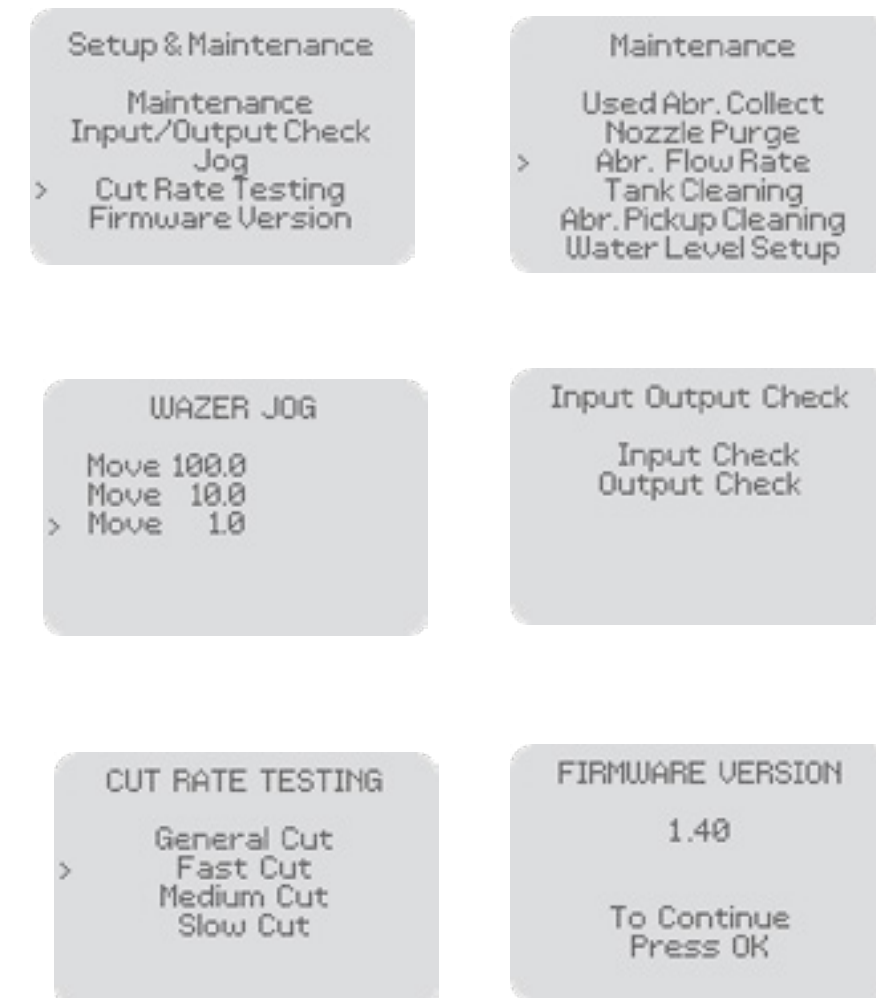

Maintenance Schedule

⚠WARNING WAZER tracks the number of hours it has been running in a menu that is located in Setup and Maintenance>Total Cut Time. This will help you take out the guess work on how many hours you have put through your machine and whether or not a particular servicing is needed.

If you do not abide by the regular maintenance procedures and schedule, the warranty and support for your WAZER will be void.

Maintenance Between Cuts

Interval: <4 hours

- Tank cleaning
- Check the Cut Bed level
- Clean abrasive hose end, check condition of O-ring, re-seat hose end
- General water sealing inspection of grommets and bellow interfaces
- Once dry, brush away used abrasive on door window, bellows, and side of tank

Short Term Service

Interval: 20-100 hours (350-1650lbs /160-750kg) of abrasive

- Flipping or Swapping the Cut Bed & Inspecting the Tank Pierce Plate
- Cleaning the Drain Filters
- Cleaning out the Tank
- Checking the Abrasive Flow Rate
- Inspecting the High-Pressure O-Rings
- Pump Box Oil Change (first time)

Medium Term Service

Interval: 300 hours (5000lbs /2200kg) of abrasive

- Pump Oil Change
- Lubricating the Gantry
- Replacing the Orifice

Long Term Service

Interval: 1,000 hours (13250lbs/6000kg) of abrasive

- Rebuilding the Pump Box

Maintenance & Machine Procedures

Short Term Service

Interval: 20-100 hours (350-1650lbs (160-750kg) of abrasive)

Flipping/Swapping the Cut Bed & Inspecting the Tank Pierce Plate VIDEO

WAZER's Cut Bed is intended to be a consumable, which means it will need to be replaced every so often. **It's also reversible:** if your current Cut Bed is worn, but you haven't yet used the bottom side, then you can flip the Cut Bed rather than replacing it. If you have already used both sides, then you will need to acquire a new Cut Bed. In either case, the series of steps to replace or flip over your Cut Bed is the same.

⚠CAUTION To avoid cuts and possible infection, wear waterproof protective gloves and handle all pieces carefully.

- Turn off WAZER and push the Nozzle to the back of the machine.
- Using the provided Cut Bed Installation Tool in the Spare Parts bag, remove the four Cut Bed Bolts that hold the Cut Bed to the Tank. These Cut Bed Bolts are below the water line, so if you just got done cutting, they may be a bit difficult to see with the murky water.
- A large amount of abrasive and water will leak out of the Cut Bed. This will continue for some time after removal, so we suggest you acquire a waterproof container (a bin or industrial garbage bag) large enough to hold the Cut Bed. Lift the Cut Bed out of the Tank and into the container.
- Flip the Cut Bed upside down, so the side you were just cutting on is facing away from you.
- Remove the brackets that are attached to the bottom of the Cut Bed.
- If this side of the Cut Bed is new, simply flip the Cut Bed over so the worn side is now facing you. If both sides of the Cut Bed are worn, dispose of it and grab a new one.
- Reattach the aluminum brackets onto the bottom of the Cut Bed.
- **Do a thorough Tank cleaning while the Cut Bed is removed.** If you have been running long Cuts, or if you have not been running additional Tank Cleaning cycles after Cuts, there may be some Used Abrasive buildup in the bottom of the Tank.
 - Take this opportunity to scoop out the excess Abrasive from the bottom of the Tank.
 - Pour clean water over the Drain Filters beneath the Rear Tank Cover to flush out excess Abrasive. This will help the Tank drain more efficiently while cutting.
- **NOTICE** Do a full inspection of the aluminum Tank Pierce Plate at the bottom of the Tank before replacing the Cut Bed. While the Cut Bed is removed, and once all excess Used Abrasive has been cleared, inspect the Tank Pierce Plate at the bottom of the Tank for damage. Contact WAZER Customer Support for a replacement if you see deep marks – remember that all the water in WAZER will drain out if this Tank Pierce Plate is punctured.
- Check to make sure the Cut Bed Posts have Cut Bed Springs around their top. If they do not, they may have fallen off the Cut Bed Posts during disassembly, so you may need to dig around in the Tank for them.
- Place the four Cut Bed Bolts in through the aluminum Cut Bed Brackets.
- Lower the Cut Bed into the Tank, making sure to align the Cut Bed Bolts with the Cut Bed Springs, and consequently with the Cut Bed Posts.
- Tighten the Cut Bed Bolts down until you feel resistance from the Cut Bed Springs, then turn each bolt one more full turn.

When tightening Cut Bed Bolts, if at any point you feel an abnormal amount of resistance, please stop, back the Cut Bed Bolts out and attempt to clean out the threads. It is likely that abrasive has been caught and is preventing you from tightening the Cut Bed Bolt.
- You are now ready to level your Cut Bed. To complete the Cut Bed replacement, you must now perform the leveling procedure found in Section 7: Maintenance > Misc Procedures> Leveling the Cut Bed.
- If this is your first service, perform the Pump Box Oil Change.

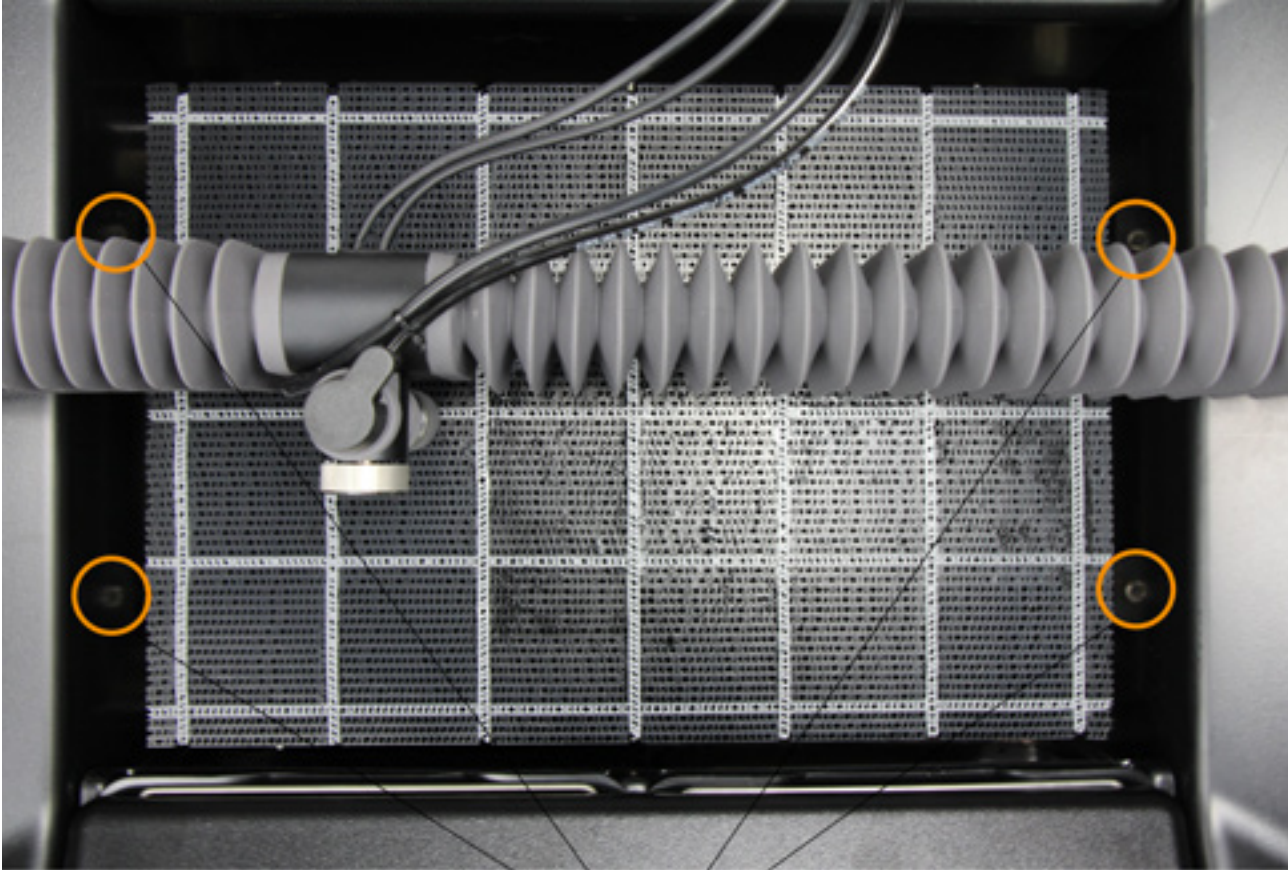

Cut Bed Bolts

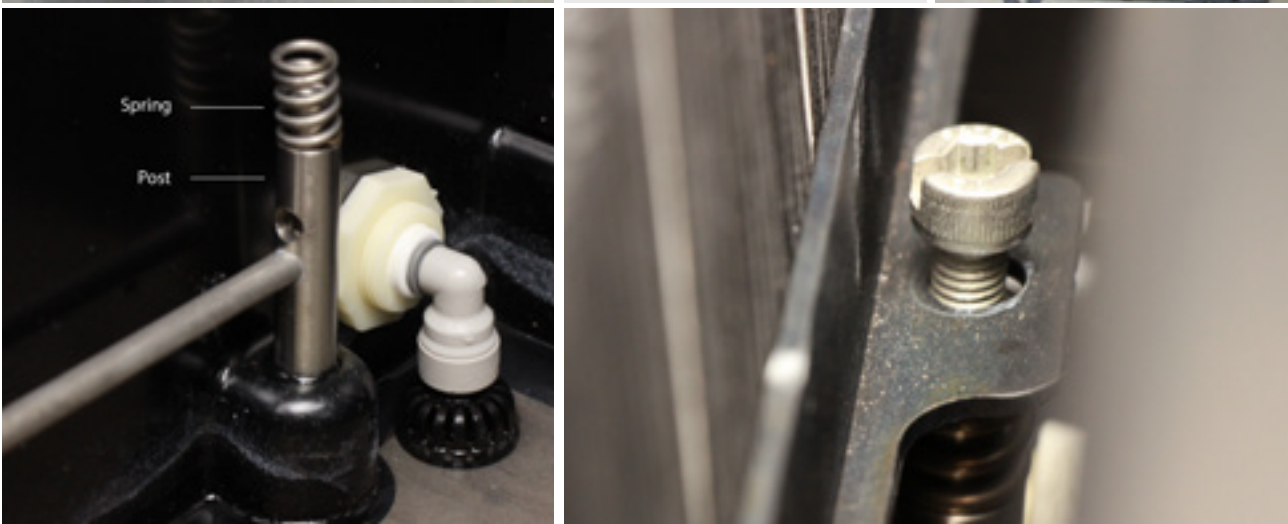
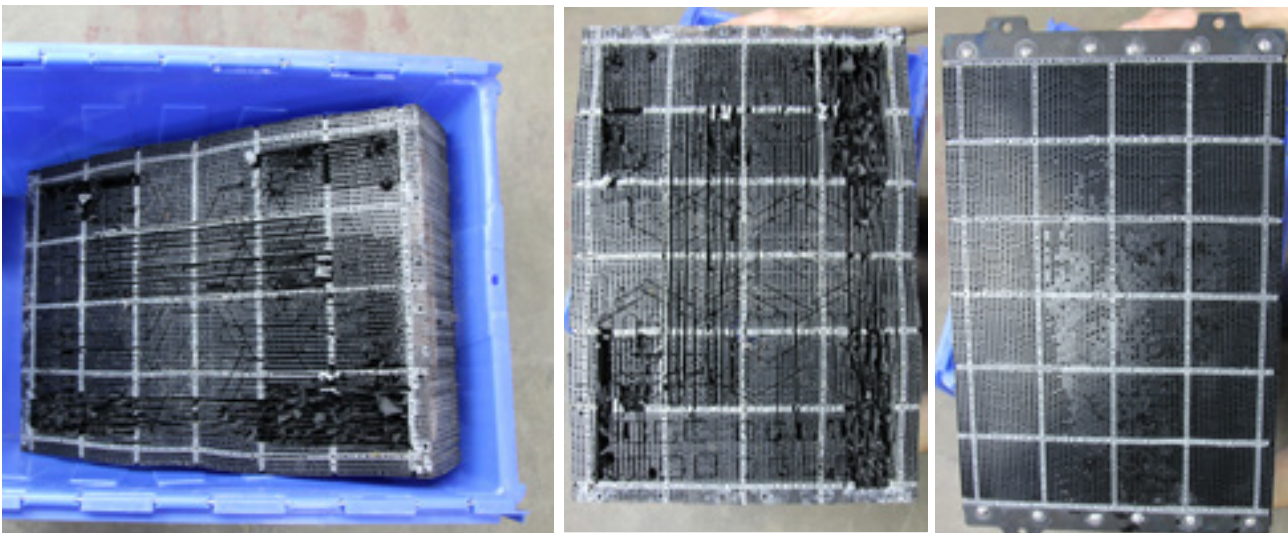

Cleaning the Drain Filters [▶ VIDEO](#)

WAZER incorporates two reusable stainless steel Drain Filters to limit the amount of debris in the drain water. These two Drain Filters are located at the back of the Tank of WAZER underneath the Rear Tank Cover.

⚠ CAUTION To avoid cuts and possible infection, wear waterproof protective gloves and handle all pieces carefully.

To clean the Drain Filters:

- Open the Door of the WAZER.
- If you are not in the middle of a Cut, move the Nozzle to the front of WAZER to give yourself more room. If you are, then be careful to not hit the Nozzle with sufficient force to move it, as this will cause a Failed Cut.
- Remove the Rear Tank Cover from the back of the Tank to reveal the Drain Filters.
- Unscrew / Remove the left-side and right-side Drain Filters from their ports at the back of WAZER.
- Dunk the Drain Filters into water to rinse the debris out; do not wipe the Drain Filter.
- Screw the left side and right side Drain Filters back into WAZER. A half turn to one full turn is sufficient, DO NOT tighten these fully. If you have Drain Filters without threads, simply insert them back to the fittings.
- Replace the Rear Tank Cover
- While you are back here it is highly encouraged to stir up the water near the float sensors to dislodge any sediment that may have collected on these float switches. Be sure to not turn or twist them, just lightly stirring or pouring clean water on them is sufficient.

Cleaning Out the Tank

WAZER collects Used Abrasive from the four corners of the Tank. During cutting abrasive is pushed into the corners by the main cutting jet. However, some abrasive can still accumulate in the middle and edges of the Tank, especially if you are only cutting in one area. To collect this Used Abrasive, run the Tank Cleaning Cycle from the Setup & Maintenance menu of the Control Panel. This procedure will help prevent any clogs in the Filtration System. We also recommend running this cycle before cutting if your machine has been sitting for a long time with abrasive in the bottom.

To run a Tank Cleaning cycle:

1. Prepare WAZER as you would for cutting (typical startup procedure to the point you are ready to select a Cut File). Make sure the water supply is on and both WAZER and Pump Box are being powered.
2. Remove any Material and Fastening Screws from the Cut Bed.
3. Raise the Nozzle Height so that it won't collide with the Cut Bed.
4. Select Setup & Maintenance > Maintenance > Tank Cleaning on the Control Panel and press Start to begin the Tank Cleaning Cycle.
5. Allow the Tank Cleaning Cycle to finish running.
6. Select Setup & Maintenance > Maintenance > Used Abr. Collect
7. Allow to run until the flow is clear. When it does press okay to end collection.
8. Empty the Used Abrasive Buckets if they are relatively full.
9. There will always be some used abrasive left in the tank bottom after tank cleaning is performed.

NOTICE It is important that you run a Tank Cleaning Cycle after every cut. This will help keep WAZER clean and will prevent you from scooping Used Abrasive out of the Tank by hand. Failure to do so will result in damage to the machine.

⚠ CAUTION Bacteria can build up in the standing water of the tank. Any injuries or cuts, even minor ones, should be treated with caution. If you have an open wound avoid contact with the water or wear gloves that do not expose you to the tank water.

Rear Tank Cover

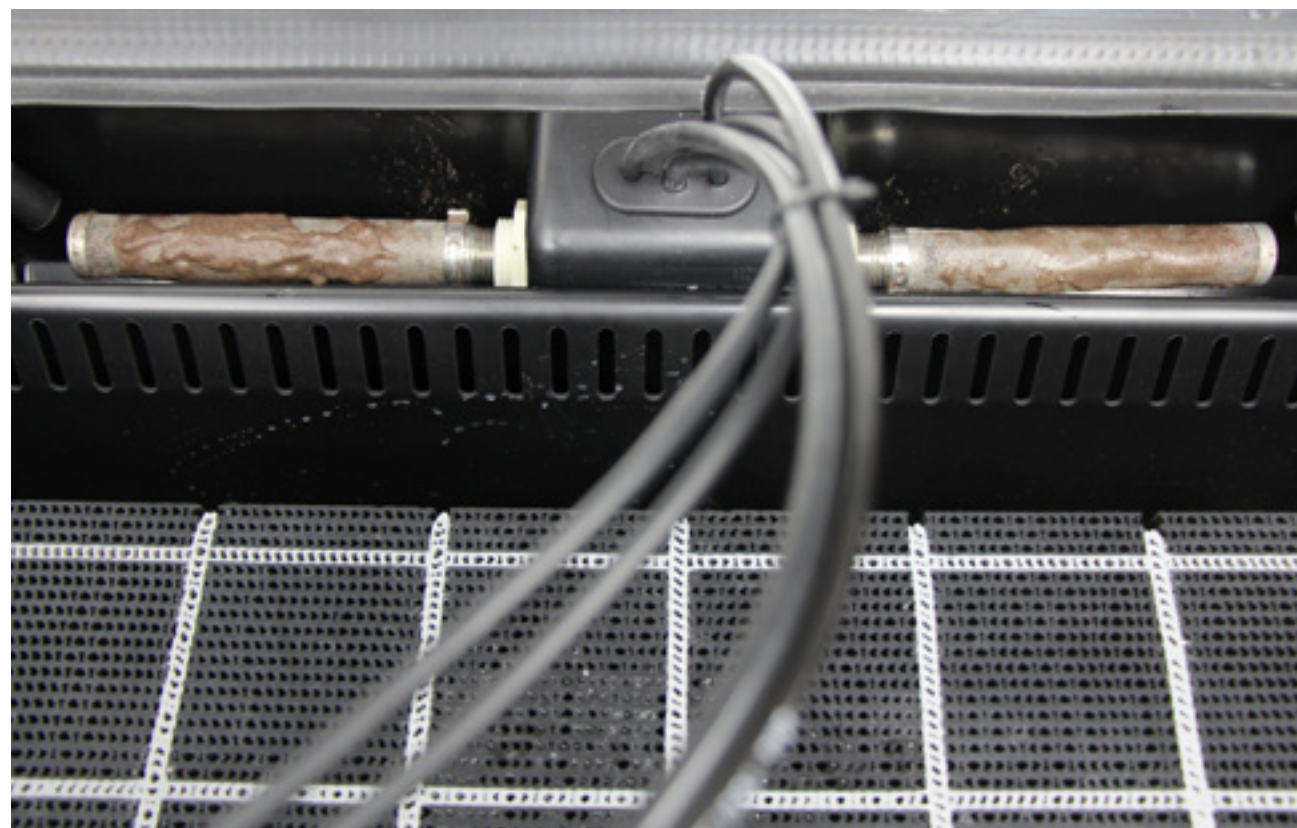
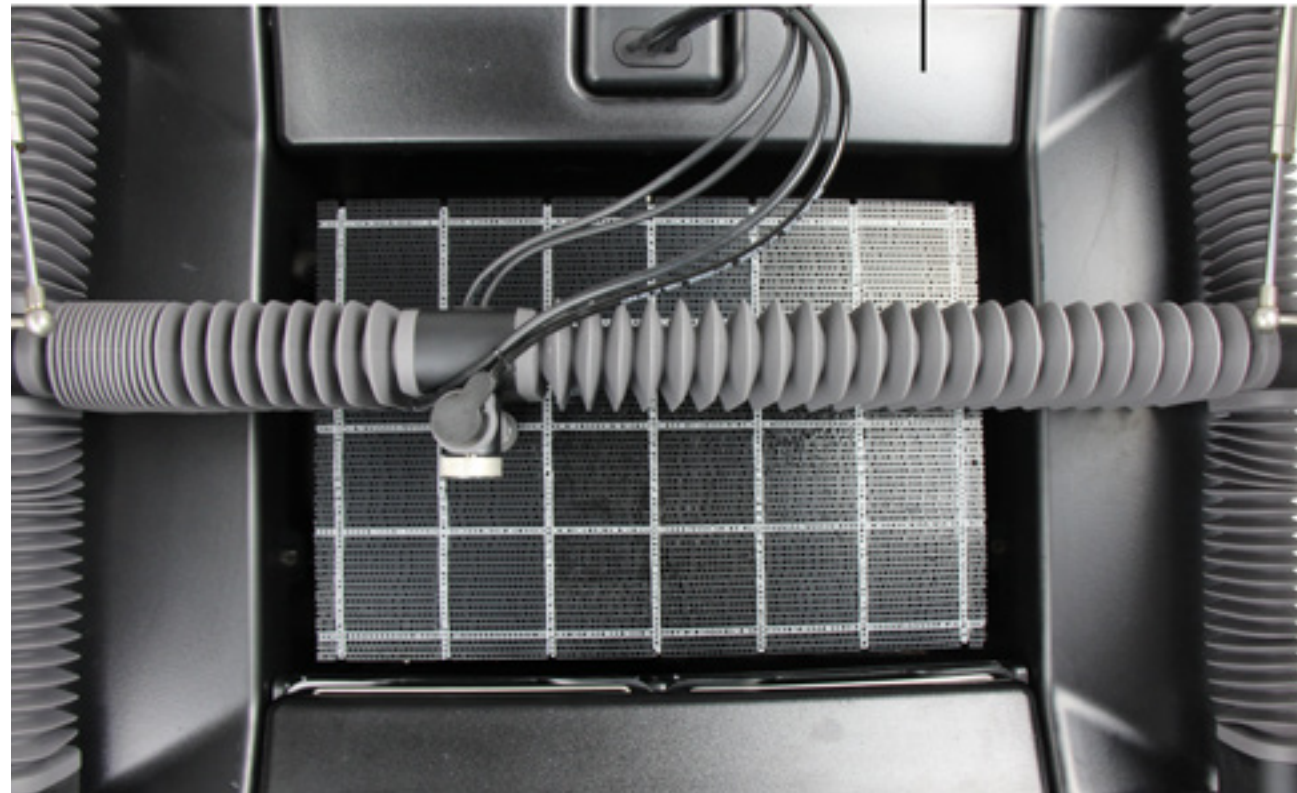

Checking the Abrasive Flow Rate

WAZER does not actively monitor and measure its Abrasive Flow Rate. However, the Abrasive Flow Rate is a critical parameter, so you should check and monitor this regularly. It is also one of the first things to check if your cut performance has seemed to change. This rate will need to be updated from time to time simply because of normal wear or from an unexpected event such as a backflow.

Required Tools

- Scale w/ accuracy of +/- 0.5g (+/-0.02oz) and capacity of at least 200g (7 oz)
 - Cup with a volume of 250ml (8oz)
1. Start out with 3kg +/-0.25kg (6.6lbs +/-0.6) of Abrasive in the hopper.
 2. Open Abrasive drawer.
 3. Remove Abrasive Valve Plug.
 4. Select Setup and Maintenance.
 5. Select Abr. Flow Rate.
 6. Place (or hold) a cup or container below the Abrasive Valve.
 7. Now hit okay to begin the flow of abrasive.
- If the valve simply doesn't open consistently see Machine Procedures > Pinch Valve Teardown.
 - The timer will count while the abrasive is flowing.
8. After the 1 min Abrasive Flow test weigh the container with the Abrasive, then subtract the weight of the container. This is the abrasive rate per minute. The goal abrasive rate is between 140 g/min - 162 g/min (4.94 oz/min - 5.71 oz/min). If the rate is lower than that you should investigate your Dry Abrasive system for the problem. If it is higher then that your Abrasive Orifice is worn out, contact Support for a replacement.

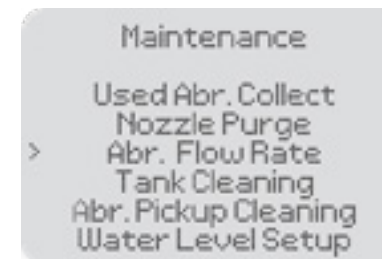

Next Time

Over time the abrasive rate of the machine will change due to a variety of reasons, including but not limited to wear, backflow events, or clogs. Often the earliest indication that the abrasive orifice will need to be changed is that you exhibit partial cutting (rate too low) or your cut-time does not correlate with the amount of abrasive you have used (rate too high). We also recommend checking the abrasive rate after any clog or backflow, as either event can change the rate.

Practicing good cutting procedures will help prevent the abrasive orifice from getting clogged and changing the abrasive rate. These include:

- Avoid letting the cutting head touch the material by leveling your Cut Bed and setting your nozzle height.
- Avoid letting the abrasive hopper run out.
- Pay attention to the amount of abrasive used in comparison to what WAM predicts the usage to be
- Always use your sifting Screens when adding abrasive.
- Beyond that, normal wear and tear is a part of any machine tool and is to be expected.

Inspecting the High-Pressure O-Rings VIDEO

NOTICE The High-Pressure Hoses need to be checked for wear every 20 – 50 hours. If you do not properly identify wear in the High-Pressure O-Rings, they can become damaged and lead to a severe leak.

To check the High-Pressure O-Rings:

- Follow the “Safety Instructions” on the “Hose Disconnect Procedure” label next to both sides of the High-Pressure Hose connections. This includes:
 - Ensure the High-Pressure Hose is purged by selecting Setup & Maintenance > Maintenance > Nozzle Purge on the Control Panel. Allow the Nozzle Purge cycle to finish.
 - Turn off WAZER.
 - Disconnect Pump Box and WAZER Power Cables.
 - Disconnect Pump Box Signal Line.
 - Turn off the water supply.
 - Unplug Water Inlet Hose.
- **WARNING** Disconnect both sides of the High-Pressure Hose to completely disconnect it by pulling back on the knurled collet of the Connector and pulling the hose out of the Connection.
- Look into the ends of the High-Pressure Hose Connector and check to see if the O-Ring is frayed, worn, misaligned, or otherwise damaged and needs to be replaced. If one or both of the High-Pressure O-Rings look damaged in any way, simply replace them with one of the spare O-Rings we provide in the Spare Parts accessory bag. If you are out of spare O-Rings please contact WAZER Customer Support for replacements.

To replace the High-Pressure O-Ring:

- Use a pick or needle nose pliers to remove the damaged High-Pressure O-Ring from the High-Pressure Hose Connector.
- Push a fresh High-Pressure O-Ring into the Connector and use a pick or needle nose pliers to push it into place. You should see it nest inside the Connector if installed correctly.
- Reconnect the High-Pressure Hose to WAZER and Pump Box. If your O-Rings were damaged, ensure that the High-Pressure Hose does not bend or turn aggressively.

Maintenance & Machine Procedures

Medium Term Service

Interval: 300 hours (5000lbs/2200kg) of abraisve

Pump Box Oil Change

The Pump Box oil needs to be changed after the first 50 hours of use, and then every 300 hours after that. These oil changes aren't done because of the degradation of the oil, but because of the impurities that will find their way into the oil over time. These impurities will result in premature wear if allowed to stay in the oil for extensive periods of time (>300hours).

1. If you have recently been cutting with WAZER, allow the Pump Box to cool for approximately 30 minutes before service.
2. If WAZER has not recently been running, turn WAZER on for 30 seconds (i.e. start a Cut and cancel it, or run part of a Tank Cleaning cycle). This will stir up the oil and impurities so they can be removed when you drain the oil.
3. **WARNING** Follow the “Safety Instructions” on the “Cover Opening Procedure” label near the back of the cover. **This includes:**
 - Turn off the water supply.
 - Turn off WAZER
 - Disconnect the Pump Box Power Cable.
 - Disconnect the Pump Box Signal Cable.
4. You can now move the Pump Box to a convenient place to work (i.e. Workbench, table or open floorspace). Remember that this unit is heavy and requires two people to lift or move. Also, the gray sheet metal Pump Box Cover is NOT structural and should not be used as a lift point.
5. Loosen (you DO NOT need to remove) the four fasteners that hold the Pump Box Cover on. You should be able to loosen these with a 4mm allen key tool. Two are located along the back edge and two on the bottom front edge.
6. Remove the Pump Box Cover by pulling the bottom front edge forward and lifting top edge up.
7. The Oil Drain Plug is located at the bottom of the crankcase. You will need to find a container to collect the drained oil from this location. Prop the Pump Box up so you can slide the container under this plug.
8. Remove the Oil Drain Plug with a 17 mm wrench. Wait for all the oil to drain.
9. Replace the oil drain plug and tighten until snug. Wipe the area down of ALL excess oil so that you can assess any leaks or drip later.
10. Remove the yellow Pump Vent Cap.
11. Refill the oil with approximately 15 oz of a SAE15W40 oil. The correct oil level is visible in the crankcase window that is located on the opposite side of the pulley. The correct level is in the middle of the window, between the high and low levels.
12. Replace the yellow Pump Vent Cap.
13. Wipe the Pump Box clean of any oil.
14. Replace the cover and tighten the Pump Box Cover Knobs so the cover is securely fastened. Ensure that these are well-secured to prevent unwanted vibration noises and the cover rattling loose during operation.
15. Reconnect and set up the Pump Box:
 - a. You'll need to reconnect the High-Pressure Hose and Water Inlet Hose.
 - b. Because you made modifications to water connections, perform a leak test before making any electrical connections.
 - c. Connect the Signal Cable between WAZER and Pump Box.
 - d. Reconnect the Pump Box Power Cable.

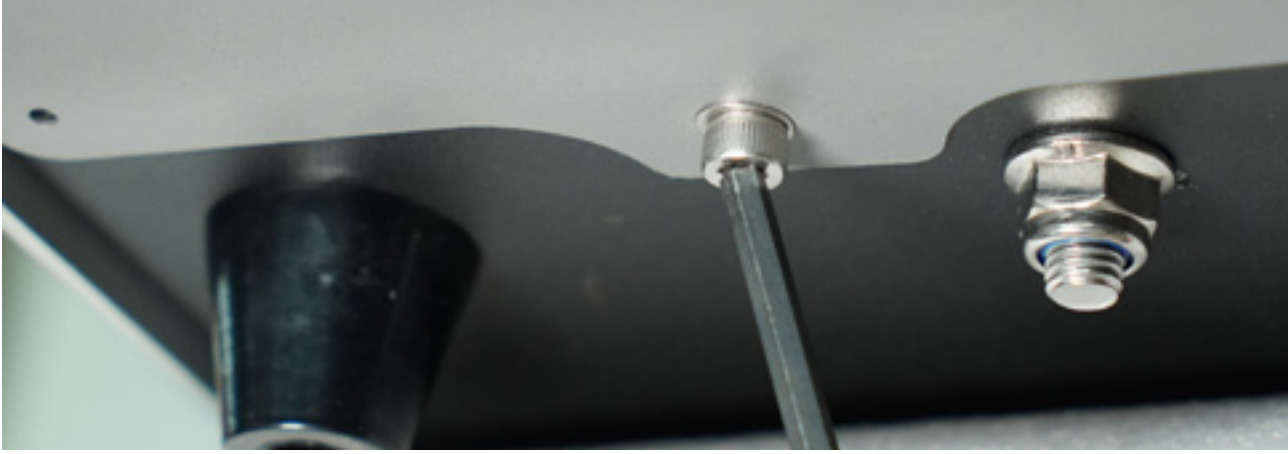

Replacing the Cutting Head [▶ VIDEO](#)

After about 300 hours of cutting, you will need to replace the cutting head in order to maintain cut quality. Here is how to swap the cutting head on your machine.

Tools Needed:

- Eye Protection
- Torque wrench with 17 mm socket
- Pliers to hold the cutting head
- Tape

Procedure

- Remove the spacing tool from the top of the cutting head and disconnect the abrasive line.
- Use the 17mm wrench to open the banjo bolt on top of the cutting head counterclockwise in one smooth motion. Make sure to hold the cutting head using your pliers by the flats toward the bottom in order to avoid any damage to the gantry.
- Remove the bolt completely and discard the old O-rings.
- Remove the knurled knob from the cutting head.
- Remove the two 4mm Allen bolts. The cutting head will be completely separate from the gantry.
- Discard the old cutting head and prepare the new head for installation. Make sure not to confuse the two. You may wish to tape the old head in order to mark the difference.
- Place the new cutting head straight vertically onto the gantry block and reattach the two 4mm Allen bolts. Failing to install the head straight can result in slanted cuts and lower performance.
- Screw in the knurled knob.
- Place one washer onto the banjo bolt, then install in water fitting and place another washer onto the other side of fitting.
- Hold the cutting head with pliers by the flats near the abrasive inlet hole. Reattach the water line to the cutting head and tighten the bolt with a torque wrench set to 18 NM and 17 mm socket.
- Air will be introduced into the line. Follow the HP priming procedure to ensure proper flow.

Pump Rebuild

- Please contact WAZER for information on this procedure.
- When return shipping is needed, please follow the instruction on WAZER.com to properly prepare the Pump Box for shipping.

Miscellaneous Procedures

You may need to perform these tasks during setup, maintenance, or in response to cutting issues, conditions, or wear you notice during use or routine maintenance.

Priming the Plumbing VIDEO

Required for initial WAZER setup and restart after maintenance

This procedure will ensure that both the low-pressure and the high-pressure water lines have no air in them and are fully primed with water, setting up your machine to have an error free and flawless cut. This will take you less than 5 minutes but if it is not done, you may have your cut interrupted by water leveling errors or an abrasive clog.

After your initial cut, this procedure will not need to be conducted under normal daily or weekly operation, however you may need to conduct it in the future under certain conditions:

- If the tank is drained, the low-pressure system should be re-primed.
- If the low-pressure or high-pressure lines are disconnected, the high-pressure system should be re-primed.

Preparation:

Once your WAZER is setup to the point of the tank being filled and the water being plumbed into the Pump Box (see Setting Up WAZER & Cut Preparation), you are ready to Prime the Low-Pressure System and then Prime the High-Pressure System.

To Prime the Low-Pressure System:

- Fill WAZER tank as instructed
- Open Drain Filter Cover, lightly tap Drain Filters, to let trapped air escape. You will see bubbles coming out.
- Turn WAZER on.
- Select the "Setup & Maintenance" on the Control Panel.
- Select "Peripheral Check".
- Remove the front bucket cover.
- Select Low Pressure Pump ("LP Pump") and allow pumps to run for 15 seconds. During this period observe the outlets of the used abrasive collection system. You should see the water stream go from being anemic to a steady and strong stream.
- Refill water in the tank to the level of the cut bed. If you didn't see a steady strong stream, make sure to repeat by selecting "Low Pressure Pumps" from previous step.

To Prime the High-Pressure System:

- Turn WAZER on.
- Select "Setup & Maintenance" on the Control Panel.
- Select "Peripheral Check" >"HP Valve".
- **NOTICE** Remove the Abrasive Hose End from Cutting Head. This is critical, do **NOT** omit this step!
- Raise the cutting head approximately 0.5" (13mm) above the cut bed surface so you have room to observe the stream coming out of the nozzle.
- Make sure door is closed. Press OK.
- Watch and listen to the stream carefully as the air leaves the stream and it transitions to just water. This can be both seen and heard as the water stream will change from a white irregular flow that makes a slight hissing sound to a clear smooth stream that should be silent. If your water supply pressure is relatively low (< 40psi) or water supply lines are long, you may need to select the "HP Valve" option from step 4 multiple times to get all the air out of the system.

PERIPHERAL Check

- > LP Pump
- Dump Valve
- Vibration Motors
- Abrasive Valve
- HP Valve
- HP Pump

Input Output Check

- > Input Check
- Output Check

PERIPHERAL Check

- > LP Pump
- Dump Valve
- Vibration Motors
- Abrasive Valve
- HP Valve
- HP Pump

HP Valve

- Remove Abrasive Tube From Nozzle

When Completed Press OK

PERIPHERAL Check

- > LP Pump
- Dump Valve
- Vibration Motors
- Abrasive Valve
- HP Valve
- HP Pump

HP Valve

- Remove Abrasive Tube From Nozzle

When Completed Press OK

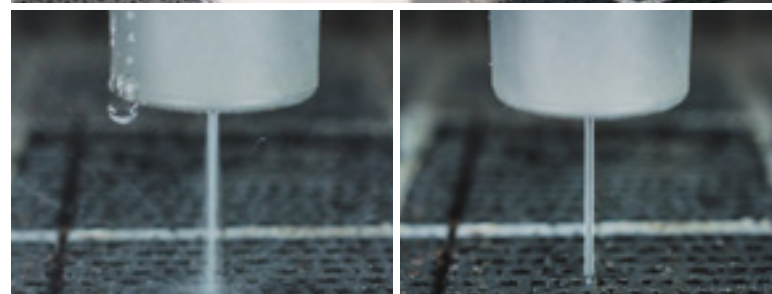

Tank Cleaning Cycle

The Filtration System collects Used Abrasive from the four corners of the Tank. However, some abrasive can still collect in the middle and edges of the Tank, especially if you are only cutting in one area. To collect this Used Abrasive, run the Tank Cleaning Cycle from the Setup & Maintenance menu of the Control Panel. This procedure will help prevent any clogs in the Filtration System.

- Remove any Material and Fastening Screws from the Cut Bed.
- Raise the Nozzle Height so that it won't collide with the Cut Bed.
- Select Setup & Maintenance > Maintenance > Tank Cleaning on the Control Panel and press Start to begin the Tank Cleaning Cycle.
- Allow the Tank Cleaning Cycle to finish running.
- Empty the Used Abrasive Buckets.
- Continue to run Tank Cleaning cycles until the amount of Used Abrasive collected in the Buckets is minimal, or once there is no excess Used Abrasive piled up in the Tank.

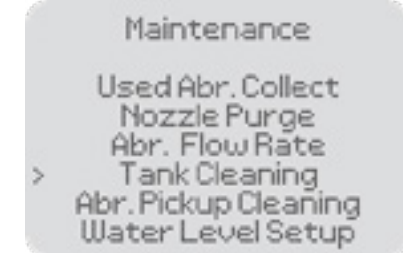

It is important that you run a Tank Cleaning Cycle after every cut. This will help keep WAZER clean and will prevent you from scooping Used Abrasive out of the Tank by hand.

Cleaning the Abrasive Hose End

NOTICE The end of the Abrasive Hose End accumulates silt over time and can result in the clogging of the line, which can ruin your Cut.

- To prevent this from happening, dunk the Abrasive Hose End into the Tank water to loosen any debris and shake it out, repeat this 2-3 times before inserting it back into the Nozzle.
- When you insert the Abrasive Hose End back into the Nozzle, make sure that both black O-Rings are fully seated in the Nozzle. This seal is critical to the performance of WAZER. If you see excessive wear on the Hose End or O-Rings, replace them as soon as possible.



Cleaning the Abrasive Hopper and Abrasive Hose

NOTICE Occasionally, you will find that a piece of debris or a clog occurs somewhere within the Abrasive Hose. Or worse yet, you had water backflow into your Abrasive Hose. This needs to be cleared out in order to make sure WAZER is supplied with sufficient Abrasive to cut.

- Turn off WAZER.
- Pull the Abrasive Hopper out.
- Disconnect the vibration motor and pinch valve connectors which are located on the underside of the Abrasive Hopper.
- Disconnect the Abrasive Hose from the Abrasive Hopper.
- Pull the Abrasive Hopper out of WAZER.
- Remove the top covers of the Abrasive Hopper.
- Dump the Abrasive out of the Abrasive Hopper and inspect it for any clumps (this will tell you if water got into the Abrasive Hopper) or for pieces of debris that are not abrasive.
- Check the pickup fitting on the inside of the Abrasive Hopper for any Material that may have gotten stuck. If you see anything remove it.
- Remove the rubber plug that is located on the bottom of the Abrasive Hopper.
- Wearing safety glasses, spray 10-15 psi of air into the opening of the pickup fitting on the inside of the Abrasive Hopper while holding the Pinch Valve Button. This will clean out the hose.
- Hold the Pinch Valve Button and peer through the bottom of the Abrasive Hopper. Verify that it is dry and clear of obstruction. Then insert the rubber plug back into the bottom of the Abrasive Hopper.
- **⚠WARNING** Wearing safety glasses is required when removeing the Abrasive Hose End from the Nozzle and have someone hold it (pointing it at the Cut Bed). Spray 10-15 psi of air into the Abrasive Hose that connects to the Abrasive Hopper for 15 seconds. DO NOT spray more than 15 psi of air into the hose, as this can damage the hose and mechanism.
- Inspect that both ends of the Abrasive Hose are clear and insert them into their respective places. Verify that both ends of the Abrasive Hose are dry and clear of obstruction.
- Place the Abrasive Hopper back into WAZER.
- Connect the Vibration Motor Connectors and Pinch Valve Connectors.
- Make sure to run Section 7: Maintenance > Maintenance Procedures > Abrasive Flow Rate Check after cleaning to ensure that your Abrasive Flow Rate is still correctly set.



Clearing the Filtration System

The Filtration System that keeps WAZER clean will occasionally become clogged or jammed with abrasive or air bubbles. If WAZER isn't collecting Used Abrasive at the rate you expect - for example, if you're putting more Abrasive into the machine than you're taking out - follow these steps to ensure your Filtration System is working correctly.

- Select Setup & Maintenance > Maintenance > Used Abr. Collect on the Control Panel.
- Open the Door and remove the Front Tank Cover at the front of WAZER.
- Locate the Used Abrasive Grommets in the right front corner of WAZER. There should be two streams of water shooting from the grommet. If there's no water flowing from the grommet, make sure you are still in the Used Abr. Collect mode from the Maintenance menu.
- Use your fingers to plug the two water streams coming from the grommet. Keep the stream plugged for about 10 seconds before removing your fingers. If the water flowing from the grommets was clean and clear before, it should now be murky and filled with Used Abrasive. If the water is still clear, repeat this step until you can see the abrasive being collected or the flow rate increases.
- Repeat for the other side of WAZER.
- Replace the Front Tank Cover and press the OK Button to exit the Used Abr. Collect mode.
- If you are repeatedly having this clog within a couple minutes, it is likely you have an excessive amount of Used Abrasive that has accumulated in the Tank. You may need to do this procedure multiple times or remove the Cut Bed and manually clean out the bottom of the Tank.

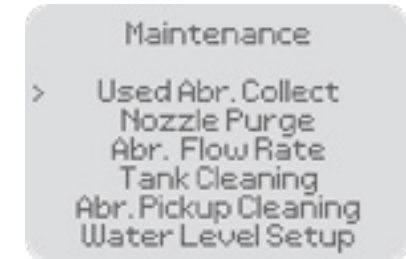

Inspecting and Replacing the WAZER fuse

The WAZER Control Box contains a fast acting fuse for electrical protection.

- Turn WAZER off and unplug it from the wall.
- Remove the Right-Side Access Panel of WAZER.
- Look at the underside of the WAZER Control Box for a round cap.
- Push this cap in towards the Control Box and turn it counter-clockwise about a 1/4 turn. Pull this cap out, which will include the fuse.
- Inspect the fuse to see if it is blown. Replace with a 5x20 mm 6 amp fast acting fuse if it is blown.
- Place the cap and fuse back into the WAZER Control Box Fuse Holder. Push in and turn it clockwise 1/4 of a turn to lock it in place.

Please refer to our website regarding the following maintenance procedures:

Replacing the Tank Pierce Plate

Setting the Abrasive Flow Rate

Replacing the Nozzle

Replacing the Abrasive Hose

Winter Safe Keeping

Replacing the Orifice

Visit wazer.com/resources or email us at support@wazer.com.

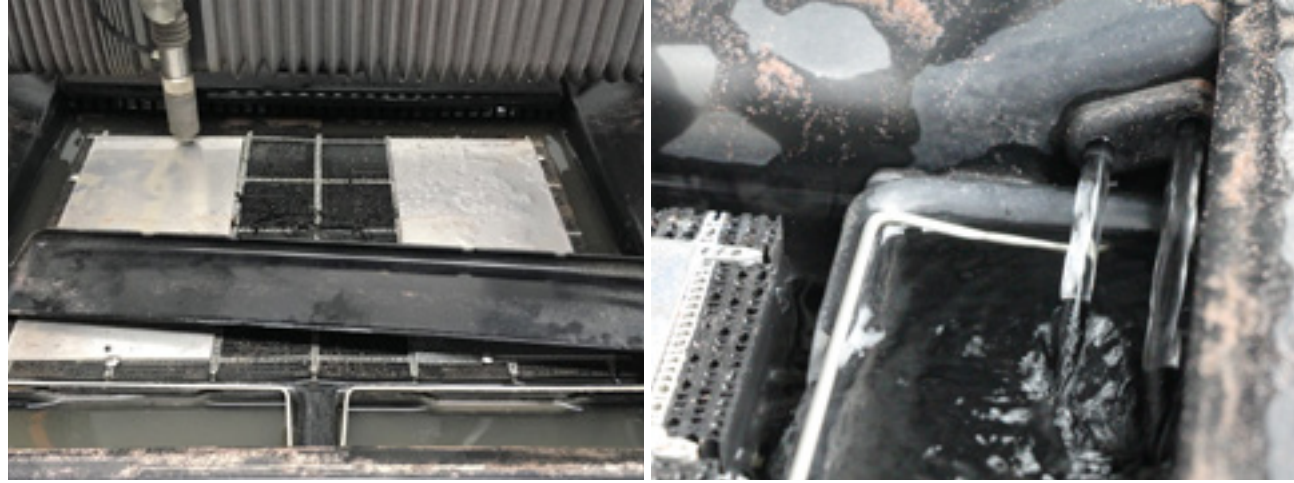

Cleaning the Water Inlet Filter

All the water going into the system is filtered at the water inlet of the pump. Over time, this can accumulate debris and sediment commonly found in most water mains. If you have particularly old plumbing, you may need to clean your filter more often. Additionally if there was a broken pipe in your neighborhood you can have more debris in the water for a time, this is more common in the winter as pipes freeze. There are two in-line water filters on your WAZER to cleanout. One is a canister style that you installed during the setup of your WAZER and another is built in to the Pump Box.

Water Filter 1 - Canister Style:

1. Remove the Water filter from the bracket. DO NOT attempt to do this step while mounted to the wall.
2. Place the drain hose into a sink or bucket
3. Turn the valve until water starts coming out of the drain hose. You will notice that wipers will start to remove the debris caught on the filter
4. After a few turns the valve at the bottom of the Water Filter will open and this debris will be removed from the water filter.
5. Turn the valve to close it
6. Replace the water filter onto its bracket.

Inlet Water Filter 2 - Pump Box Filter

Look into the back of your Pump Box where the hoses enter. At the bottom you will see the Water Inlet and just past it a clear viewing area for filter. If it is anything but clean you need to



Tools needed

- 29 mm or 1 1/8" Socket
- or a 1/2" hex wrench

Procedure



1. Follow the proper procedure for High Pressure Hose disconnection displayed on the warning label. Then remove the High Pressure Hose from the Pump Box. Let the water drip dry.



2. Remove the Inlet Water Line. Press in on the grey collar before pulling the hose out. Let the water drip dry.



3. Loosen the Thumb Screw securing the pump cover. Remove the cover.

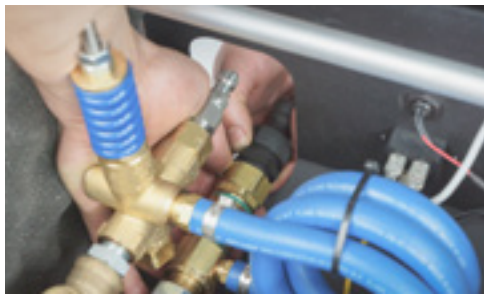

4. With one hand secure the Brass Nut then remove the plastic water inlet hose connector. This should only be hand tight



5. Use the wrench to loosen the retaining nut.

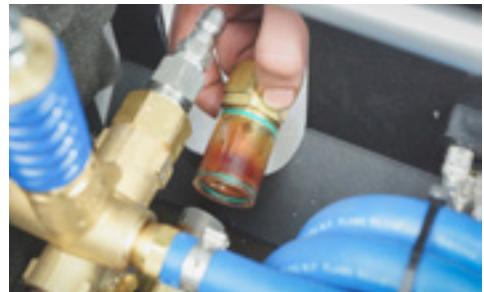

6. Pull off the plastic filter cover and the screen.

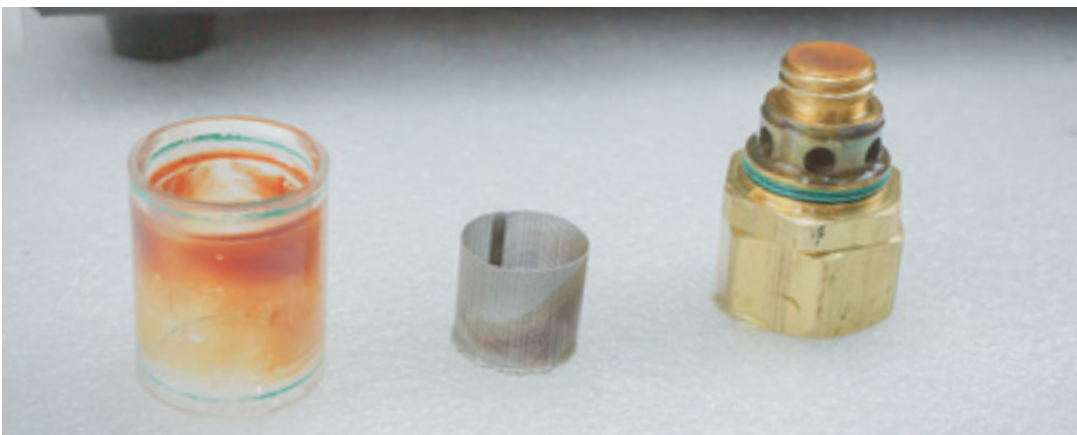

7. Clean off any debris off all surfaces. First rinse off what you can then scrub off the stubborn bits. The risk here is that a small particle can be sucked through and get stuck in the pump seals.



8. To re-assemble first place the screen back on .



9. Place the plastic cover over with the metal end nut. Re-secure with the wrench you have. Sealing here is all achieved by o-rings, so be careful and do not over-tighten.



10. Use one hand to hold the brass nut and screw on the inlet hose connector.



11. Replace the Pump Box Cover, tighten the Thumb Screws, reattach all plumbing and electrical connections and you are ready to resume cutting.

Change of nozzle orifice

If your orifice is damaged by debris you will need to change the cutting head Orifice.

While the procedure is straightforward it is important to be careful and follow the steps carefully and keep everything clean as you are working. Small debris, like a single piece of abrasive, in the system can clog or crack the orifice.

Tools required:

- 11mm, 28mm wrench
- 4mm hex key
- Pliers
- Masking tape, and cleaning tools

⚠WARNING Eye protection, facial mask required at all time.

- Follow every step of this procedure.
- Safely release residual pressure from high pressure hose before every maintenance .
- Turn off WAZER and disconnect AC power supply cables.
- Turn off water inlet.

Work procedure

- Let WAZER dry and brush away loose Used Abrasive from bellows and gentry.
- loosen and remove the knurled z-axis height adjustment.
- Use a 4mm hex wrench to remove the two bolts securing the Nozzle assembly.
- Use masking tape to cover up the exposed holes.
- Loosen and remove the knurled guard on the Nozzle - this shouldn't be more than hand tight.
- Slide down Nozzle, keep the white collar.
- Gently peel up the Z-Axis Bellow from the Mixing Chamber.
- Use 11mm and 28mm wrench to unscrew Mixing chamber from Guide rod.
- Use masking tape to cover the bottom of Guide Rod.
- The Orifice is now exposed in the body of the Mixing Chamber, you can see a tiny hole in the middle.
- Remove the Orifice from the Mixing Chamber by whacking it against your palm.
- Use a toothpick or metal dental pick to remove debris from the threads both inside and outside. Make sure no abrasive is stuck in the tread.

- Place a new Orifice into the Mixing Chamber with the brass ring facing you.
- Clean off all the Blue Goop from Guide Rod thread, inspect the thread. Make sure no abrasive is stuck in the thread.
- Reapply Blue Goop and reassemble the Mixing Chamber and Guide Rod. Pay attention to the smoothness when threads engages. Stop and clean immediately when you feel any grinding.
- Use 11mm and 28mm wrench to tighten them to 50Nm (37ft-lbs).
- Reassemble the nozzle with white collar, and knurled guard together. Make sure Nozzle is properly seated.
- Pull the lower Bellow lip back into the groove.
- Re-install the Nozzle assemble onto the Gantry using the two M5 bolts.
- Make sure nozzle assembly is perfectly vertical, reapply z-axis height adjustment.

For more detailed and illustrated manual, please refer to WAZER.com/resources/maintenance/procedure/replacing-the-orifice.

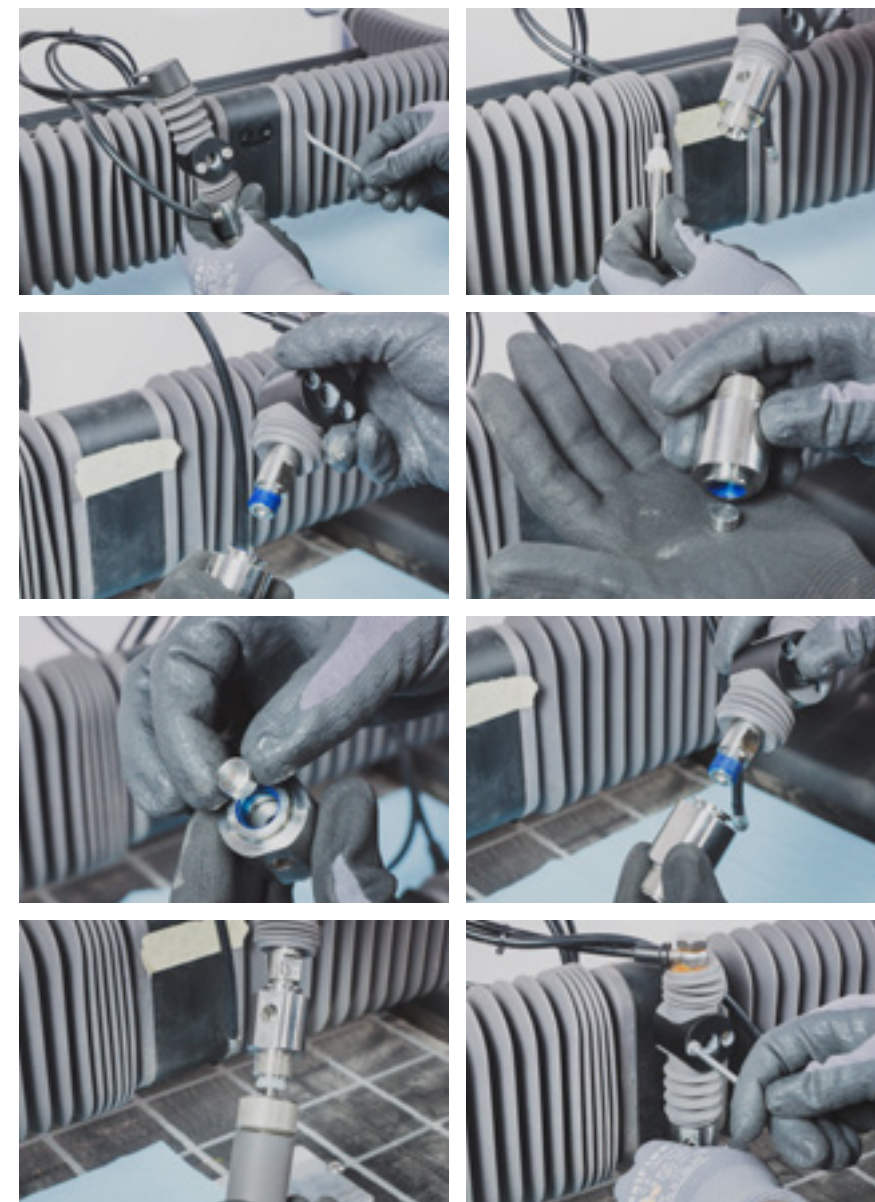

Leveling the Cut Bed VIDEO

Having a level Cut Bed is critical. The height of the Nozzle needs to be consistent at every point on the Cut Bed. If it isn't, this can result in Partial Cutting, or the Nozzle may contact the Material or Cut Bed – this can cause a Cut failure or damage to WAZER.

To level your Cut Bed:

1. Turn off your WAZER.
2. Adjust the height of the Cut Bed by tightening the Cut Bed Bolts at the corners of the Cut Bed.
3. Loosen the Nozzle Lock Knob and move the gantry to the top left corner of the Cut Bed (two inches from the edges of the Cut Bed is sufficient. You do not need to be too precise).
4. Use the Nozzle Height Tool and set the height off of the Cut Bed the same as you would with Material. Lock the Nozzle Lock Knob into place and remove the Nozzle Height Tool from under the Nozzle.
5. Slowly move the Gantry to the top right corner of the Cut Bed. Stop if you feel any resistance.
6. Assess the height of the Nozzle accordingly:
 - a. If you collide with the Cut Bed or cannot replace the Nozzle Height Tool between the Nozzle and the top right corner of the Cut Bed, use the Cut Bed Installation Tool provided in the Spare Parts bag to tighten the Cut Bed Bolt in that corner. This will lower the Cut Bed. Tighten the bolt until the Nozzle Height Tool slips between the Nozzle and Cut Bed with little to no slope or resistance.
 - b. If you do not collide and there is room between the Nozzle and Cut Bed, loosen the Nozzle Lock Knob and use the Nozzle Height Tool to reset the height off of the Cut Bed. If this is your first pass around the Cut Bed corners, we highly suggest you DO NOT loosen the Cut Bed Bolts. Instead, tighten the higher sides and lower the Nozzle. The Cut Bed Bolts must be under some tension, or the Cut Bed will move throughout the cut, leading to poor results.
 - c. If the Nozzle Height Tool slips under the Cut Bed with little resistance, this corner is set for the time being. Move on.
7. Move the Gantry around the Cut Bed and repeat Step 5 until you have leveled all four corners without needing adjustment. This may take 2-3 full loops around the Cut Bed before everything is set. Take your time doing this correctly. The gap between the Nozzle and the Cut Bed should not vary by more than 0.5 mm from corner to corner.

⚠ CAUTION Bacteria can build up in the standing water of the tank. Any injuries or cuts, even minor ones, should be treated with caution. If you have an open wound, avoid contact with the water or wear gloves that do not expose you to the tank water.

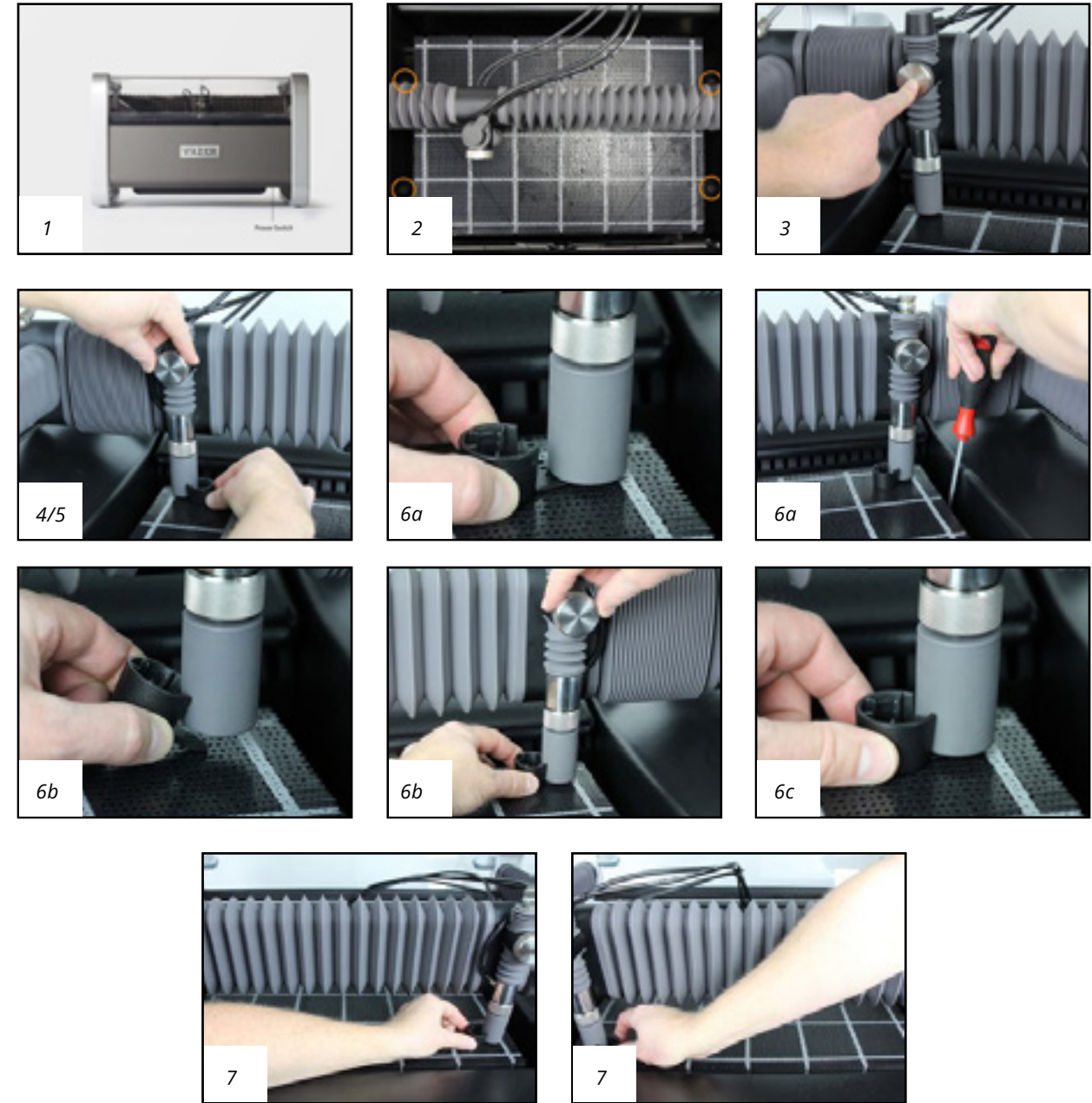

Additional Resources

SECTION

8

Customer Support

WAZER stands by its product, and we're happy to help when you need assistance with setting up or running WAZER.

We are constantly updating and putting out content that can aid in the setup, operation, and troubleshooting of cutting with WAZER. If you can't find what you are looking for within this User Manual check our online resources at wazer.com/resources. There you will be able to find information such as:

- Troubleshooting & Maintenance
- How-To Videos
- WAZER Firmware and Config Files
- Downloadable Updated User Manuals

WAZER Customer Support is here to provide help.
Visit wazer.com/resources or email us at support@wazer.com.

Decommission, Disposal and Recycling of WAZER

Decommission

To properly bid farewell to your WAZER

WAZER is a tool that contain mechanical, electric and electronic components. Unregulated disposal of such tools is strictly prohibited in many countries. Please consult your local electric appliance recycling regulation, as well as this section, before starting to decommission your WAZER.

⚠WARNING Decommission Safety Precaution

To make sure that the high pressure system is relieved of its pressure, perform a nozzle purge from the WAZER Control Panel by going to Setup & Maintenance > Maintenance > Nozzle Purge before continuing with the rest of the steps.

Disassembly process

⚠CAUTION To avoid cuts, possible infection or particle inhalation, wear waterproof protective gloves, facial mask and eye protection during the disassembly process.

Properly discard items mentioned in this section in accordance to local waste management regulation. If regulation prohibits, put them aside for more instruction.

- Drain the WAZER main unit.
- Disconnect the Main Unit from its wall anchoring.
- Follow the hose disconnect procedure printed on the safety label that is located on your Main Unit and Pump Box. Discard all of the hoses.
- Using the provided Cut Bed installation tool, remove the four Cut Bed bolts, and take the Cut Bed out.
- Cut Bed may contain cut material debris, consult your local waste management before discarding it.
- Clean used abrasive out of WAZER Main Unit tank. Leaving it dry for several days Will greatly ease the cleaning process.
- Completely dump all Dry Abrasive from the Abrasive drawer.
- Cut the two power supply cables from Pump box and 24v power supply, discard them.
- Unscrew pump box signal cable from pump box, cut it off from the Main unit, discard it.

- Open Pump box cover, replace the yellow Pump Vent Cap with red Oil Cap. If lost, contact WAZER for assistance. Put pump cover back on.
- If you have a WAZER Stand-up, take the Stand Leg and Shelf off by reversing the process of installing. Please refer to Stand Leg Accessory for installation process. Be mindful of every safety precaution.

Information acquisition:

At this stage WAZER is decommissioned and ready for disposal. Every country and region has its own laws, regulations and schemes regarding household electric appliances disposal or recycling. Please contact your local relevant authorities or agencies for detailed information.

If local laws or regulations pose significant hurdles in disposal/recycling WAZER, or no existing disposal/recycling scheme exist, contact WAZER customer service for assistance.

For EU (European Union) countries, decommissioned WAZER is regarded as Waste Electrical and Electronic Equipment, thus law-abiding disposal or recycling procedure is enforced by law. Contact WAZER customer service for assistance.

WAZER provides a free-of-charge collection program for any properly decommissioned and disassembled WAZER units.

Prepare for transportation

- If items described in "Disassembly" are prohibited from discarding by local laws and regulations, you may put them inside the Main tank at this moment.
- Use masking tape to secure movable parts, including Abrasive Hopper Drawer, Right Side Access Panel, Front and Back Tank Cover, Door window. Tape 24V power supply at the bottom Hoop.

If local authority or agencies provide door step collection service, prepare decommissioned WAZER as they request, and disregard the following instructions.

If local authority or agencies do not provide a door step collection service, you then have to prepare WAZER for transportation. Follow the following steps to safely package WAZER. Failure to comply may result in refusal of acceptance, and extra cost incurred to you.

If you do not have the original packaging, please contact WAZER customer support, stating you are looking for the return shipping package, we will ship it to you for your decommissioning process.

- Retrieve the packaging material your WAZER came in, put the heavy duty cardboard base on top of wooden pallet
- Follow WAZER's illustrated step by step guide as to how to package up a WAZER for shipment here: WAZER.com/repair-instructions/repacking-wazer-for-shipping

WAZER is ready for the upcoming Transport.

Included in the price is a contribution to recycling costs.

Warranty

Overview

THIS WARRANTY GIVES YOU SPECIFIC LEGAL RIGHTS, AND YOU MAY HAVE OTHER RIGHTS THAT VARY FROM STATE TO STATE. TO THE EXTENT PERMITTED BY LAW, THIS WARRANTY AND THE REMEDIES SET FORTH ARE EXCLUSIVE AND IN LIEU OF ALL OTHER WARRANTIES, REMEDIES AND CONDITIONS, WHETHER ORAL, WRITTEN, STATUTORY, EXPRESS OR IMPLIED. WAZER DISCLAIMS ALL STATUTORY AND IMPLIED WARRANTIES, INCLUDING WITHOUT LIMITATION WARRANTIES OF MERCHANTABILITY AND FITNESS FOR A PARTICULAR PURPOSE AND WARRANTIES AGAINST HIDDEN OR LATENT DEFECTS, TO THE EXTENT PERMITTED BY LAW. INSOFAR AS SUCH WARRANTIES CANNOT BE DISCLAIMED, WAZER LIMITS THE DURATION AND REMEDIES OF SUCH WARRANTIES TO THE DURATION OF THIS WARRANTY AND, AT WAZER'S OPTION, THE REPAIR OR REPLACEMENT SERVICES DESCRIBED BELOW. SOME STATES DO NOT ALLOW LIMITATIONS ON HOW LONG AN IMPLIED WARRANTY MAY LAST, SO THE LIMITATION DESCRIBED ABOVE MAY NOT APPLY TO YOU.

What is Covered by this Warranty?

WAZER grants an Exclusive Limited Warranty (the "Warranty") for the WAZER Desktop or WAZER Standup (the "Product"), and warrants against defects in materials and workmanship when used normally in accordance with WAZER's instructions for a period of six (6) months from the original date of receipt by the purchaser (the "Warranty Period").

- To damage caused by operating the Product outside WAZER's instructions or improper cleaning of the Product;
- To damage caused by service (including upgrades and expansions) performed by anyone who is not a representative of WAZER (except for damage that results from do-it-yourself warranty repairs, discussed below, if the repair was conducted according to WAZER instructions);
- To a Product that has been modified to alter functionality or capability without the written permission of WAZER;
- To defects caused by normal wear and tear or otherwise due to the normal aging of the Product;
- If any serial number has been removed or defaced from the Product;
- If WAZER receives information from relevant public authorities that the product has been stolen, and you cannot prove in any way that you are the authorized user of the Product (e.g., by presenting proof of purchase);
- To items consumed or expended by their normal use, such as the Nozzle, Orifice and Cut Bed (if you do cause damage from incorrect use, WAZER may be able to send you replacement parts and you may have to pay for them);
- To damage or defect caused by: etching, including any non-through-cutting; cutting or attempting to cut material greater than the maximum thickness specified for that

What is Not Covered by this Warranty?

This Warranty does not apply:

- To consumable parts, unless failure has occurred due to a defect in materials or workmanship;
- To cosmetic damage, including, but not limited to, scratches, dents, and broken plastic unless failure has occurred due to a defect in materials or workmanship;
- To damage caused by use with a third party component or product that does not meet WAZER's specifications;
- To damage caused by accident, abuse, misuse, fire, liquid contact to electronic components, earthquake or other external causes;

material in the User Manual or on the website; servicing the Product with the Water Inlet Valve opened or with the Power Cables plugged in; accident, flood, fire, or other external causes outside of WAZER's control; modification of the Product;

- The Product's software or firmware
- To damage occurring during transportation of the Product (such claims are the sole responsibility of the shipper).

Use of third-party abrasive does not in and of itself void this warranty. However, damage caused by use of third-party abrasive is excluded from this warranty.

Conditions

The Warranty is granted under the following conditions:

- The Product was assembled, sold and delivered by WAZER.
- The Product was purchased new from WAZER or authorized reseller by the claimant, or by a member of the same household, or member of the same institution/organization of the original purchaser.
- The then-latest firmware was installed and used in the Product.
- The install and maintenance instructions in the User Manual were followed.
- In the event that a warranty has expired, or is void, basic email support is offered to allow for the purchase of replacement parts of components. Troubleshooting services are not offered for machines out of warranty.

Providing evidence of the satisfaction of these conditions is a prerequisite for any remedy under the Warranty.

Transfer of Warranty

The transfer of an existing warranty is granted if the following conditions are met:

- The transfer is from one member of the household to another or from one member of the institution/organization to another.
- WAZER is notified within ten (10) business days of this transfer and can be validated through address verification and/or domain of the new "owner". Providing evidence of the satisfaction of these conditions is a prerequisite for any remedy under the Warranty.

Procedure

If you encounter an issue with the Product, here is the procedure to follow:

1. Consult your User Manual for help.
2. Submit a claim by emailing WAZER at support@wazer.com within the Warranty Period.
3. Provide proof of purchase, including the original purchaser's invoice.
4. Help diagnose any issues related to your claim. This may involve corresponding with WAZER's support team by email or phone and by sending images, videos or files related to your claim. Any warranty claim must first be accepted by WAZER as justified.
5. If your claim is accepted, WAZER, at its sole discretion will either:
 - a. Send new or refurbished parts for you to install, along with detailed instructions for do-it-yourself ("DIY") parts service. You may be required to send the original parts to WAZER before or after your replacement parts are sent. WAZER is not responsible for any labor costs you incur relating to DIY parts service. A replacement part assumes the remaining term of the Warranty or ninety (90) days from the date of replacement or repair, whichever provides longer coverage for you; or
 - b. Send you a replacement new or refurbished Product that's substantially equivalent in function, formed from new and/or previously used parts that are equivalent to new in performance and reliability. The replacement Product assumes the remaining term of the Warranty or ninety (90) days from the date of replacement, whichever provides longer coverage for you; or
 - c. Refund you the purchase amount. If so, you may be required to return the original Product prior to or after receiving the refund.
6. The shipping cost (including any duties and taxes) for any new or refurbished parts or Product sent to you in fulfillment of your warranty claim shall be covered by WAZER. WAZER will ship via non-expedited fulfillment by default. Expedited shipping may be available at an added cost to the

claimant. Replacement parts and their shipping and duties that are required due to user misuse or user error in diagnosis or fixing are not covered by the warranty.

- a. If your original shipping address is located in the Continental United States, WAZER will cover the cost of the above shipping.
 - b. If your original shipping address is located in the Continental United States, WAZER will cover the cost of the above shipping.
7. If you are asked to send back some or all of the Product to WAZER in order to fulfill your claim, the following requirements will apply:
- a. If your original shipping address is located in the Continental United States, WAZER will cover the cost of the above shipping.
 - b. A Return Authorization Label will be provided to you, which must be included in the return package.
 - c. For purchasers in the Continental United States, WAZER will provide prepaid shipping labels.
 - d. For purchasers outside the Continental United States, you will be required to pay for the return shipping.
8. WAZER reserves the right to change the method by which WAZER may provide warranty service to you, and your Product's eligibility to receive a particular method of service. Service options, parts availability, and response times may vary according to location.

Voiding Your Warranty

The Warranty is Void if:

- The Product is used outside of the country of the initial purchaser's shipping address.
- Any WAZER serial number has been removed or defaced.
- Any disassembly or reassembly by anyone other than WAZER representatives occurs, other than do-it-yourself assembly instructions outlined in the User Manual or in other official WAZER publications, or instructed by a WAZER representative.

Firmware, G-Code/CAM Software.

Critical machine functionalities are built into the firmware that prevents the machine from damaging itself, your property, and/or harming the user. The following modifications to WAZER firmware or the loading of files onto WAZER will void the machine's warranty:

The use of non-WAZER released/approved firmware and configuration files onto a WAZER machine.

The usage of any non-WAZER approved CAM software to generate g-code or manually modified/created g-code to run a WAZER. Approved g-code creation solutions will be updated by WAZER. If there is any uncertainty, please contact WAZER customer support.

Disclaimers

WAZER does not warrant your use of the Product will be uninterrupted or error free.

- WAZER does not warrant your use of the Product will be uninterrupted or error free.
- WAZER does not warrant that the results that may be obtained from the use of the Product will be accurate or reliable.
- WAZER makes no claims about the safety or effectiveness of any device made using the Product.
- No warranty will apply after the expiration of the Warranty Period.
- EXCEPT AS PROVIDED IN THIS WARRANTY AND TO THE MAXIMUM EXTENT PERMITTED BY LAW, WAZER IS NOT RESPONSIBLE FOR DIRECT, SPECIAL, INCIDENTAL OR CONSEQUENTIAL DAMAGES RESULTING FROM ANY BREACH OF WARRANTY OR CONDITION, UNDER ANY LEGAL THEORY, INCLUDING BUT NOT LIMITED TO LOSS OF USE; LOSS OF REVENUE; LOSS OF THE USE OF MONEY; LOSS OF ANTICIPATED SAVINGS; LOSS OF BUSINESS; LOSS OF OPPORTUNITY; LOSS OF GOODWILL; LOSS OF REPUTATION; OR ANY INDIRECT OR CONSEQUENTIAL LOSS OR DAMAGE HOWEVER CAUSED INCLUDING THE REPLACEMENT OF EQUIPMENT AND PROPERTY. SOME STATES DO NOT ALLOW THE EXCLUSION OR LIMITATION OF INCIDENTAL OR CONSEQUENTIAL DAMAGES, SO THE ABOVE LIMITATION MAY NOT APPLY TO YOU. PUNITIVE, EXEMPLARY, OR MULTIPLE DAMAGES MAY NOT BE RECOVERED UNLESS APPLICABLE LAW PROHIBITS THEIR DISCLAIMER.

General

No WAZER reseller, agent, or employee is authorized to make any modification, extension, or addition to this Warranty. If any term is held to be illegal or unenforceable, the legality or enforceability of the remaining terms shall not be affected or impaired. This Warranty is governed by and construed under the laws of the State of Delaware. WAZER or its successor in title is the warranter under this Warranty.